

VR-048

FOR STD SIZE, REDUCE SPACING 25%*

DIMENSIONS (INCHES)

| SIGN | A | B | C | D | E | F | G | H | J | K | L | M | N | P | R | S | T |
|----------|----|----|-----|-------|---|----|---|----|-----|----|-----|-----|--------|--------|-----|-----|-----|
| STD. | 24 | 30 | 3/8 | 3/8 | 3 | 4B | 3 | 3B | 1/2 | 3B | 2/2 | 9/2 | 10% | 10% | 6% | 8% | 1/2 |
| EXPWY. | 48 | 60 | 3/4 | 1 1/4 | 6 | 7C | 5 | 6B | 4 | 6B | 6 | 21 | 14 1/4 | 18 1/6 | 12% | 16% | 3 |
| & F.W.Y. | | | | | | | | | | | | | | | | | |

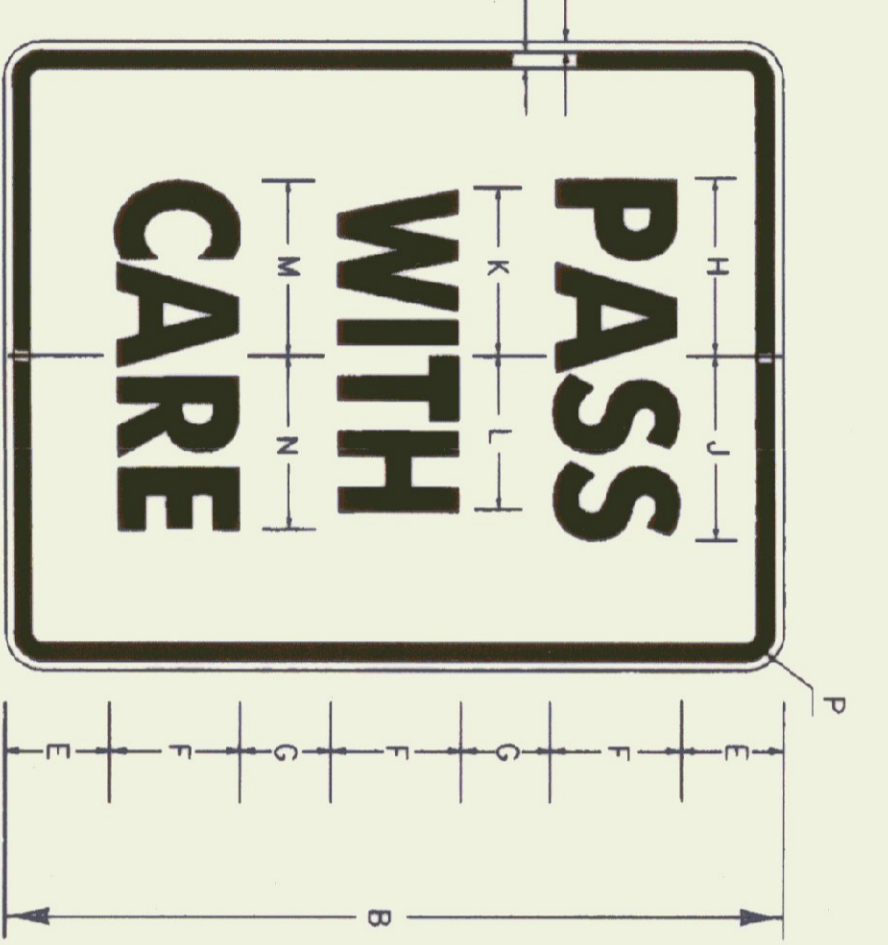

R4-2

DIMENSIONS (INCHES)

| SIGN | A | B | C | D | E | F | G | H | J | K | L | M | N | P |
|--------|----|----|-----|-------|-----|-----|-----|--------|--------|--------|--------|--------|--------|--------|
| MIN. | 18 | 24 | 3/8 | 3/8 | 3/2 | 4C | 2/2 | 5 1/2 | 5% | 5% | 4 3/4 | 5 3/8 | 5 1/2 | 1 1/2 |
| STD. | 24 | 30 | 3/8 | 3/8 | 3/2 | 6C | 2/2 | 8 3/8 | 8% | 8% | 7 1/2 | 8 | 8 1/4 | 1 1/2 |
| EXPWY. | 36 | 48 | 3/8 | 3/8 | 3/2 | 8C | 5 | 10 7/8 | 10% | 10% | 11 1/4 | 10 | 9 1/2 | 10 1/8 |
| F.W.Y. | 48 | 60 | 3/4 | 1 1/4 | 8 | 10C | 7 | 13 3/8 | 11 1/4 | 11 1/8 | 12 1/2 | 11 3/8 | 13 3/4 | 3 |

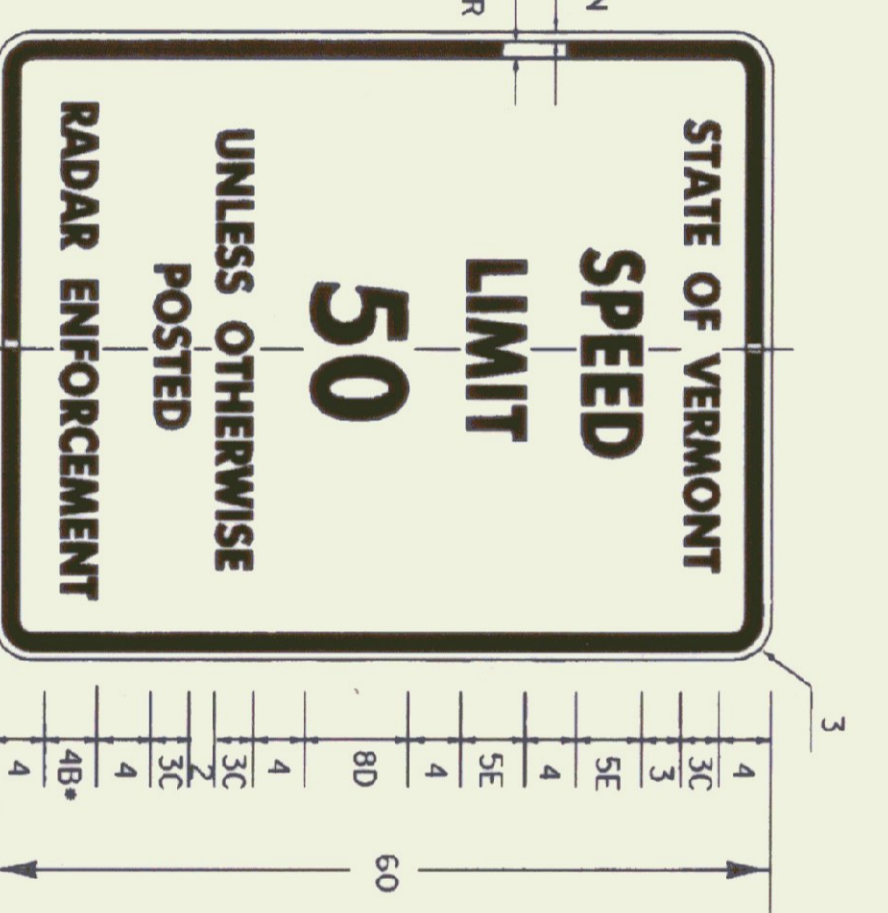

VR-114

* REDUCE SPACING 25%*

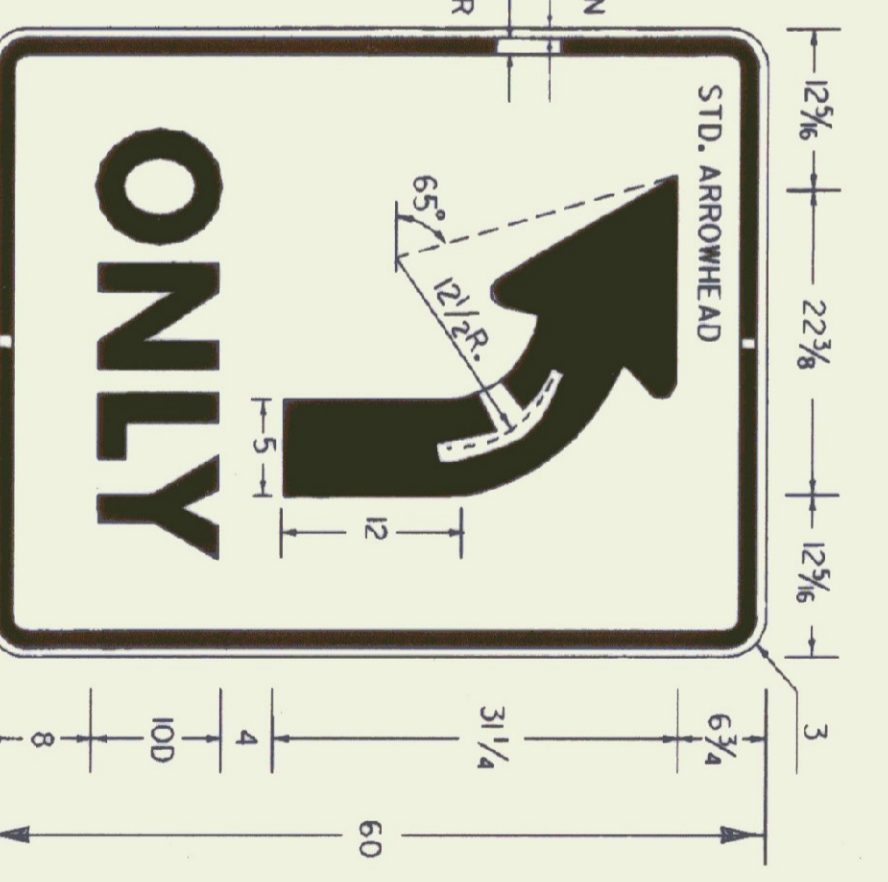

R3-5

(OVERHEAD SIGN)

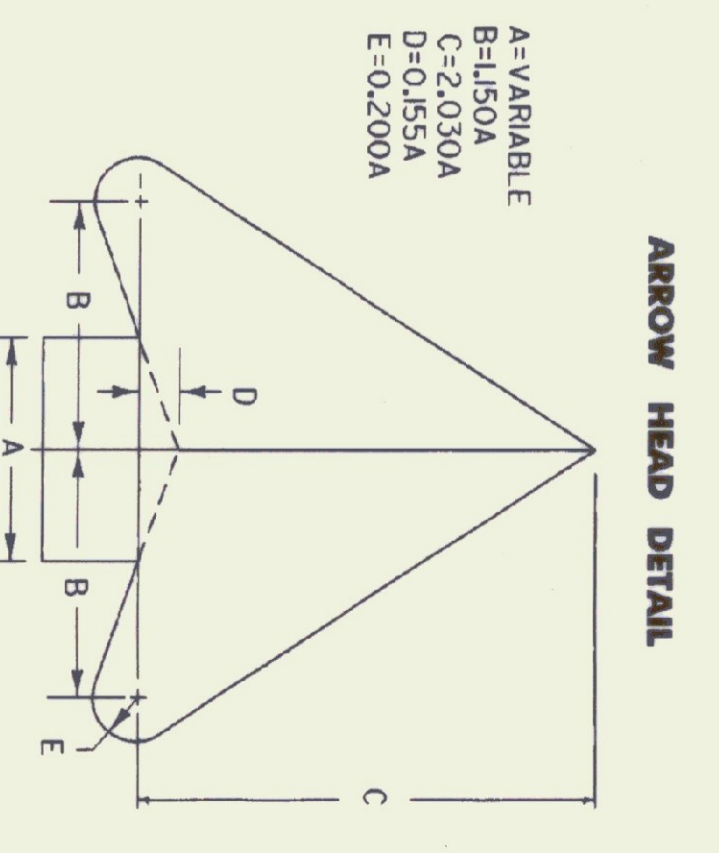

DIMENSIONS (INCHES)

| A | B | C | D | E |
|-------|-------|-------|-------|-------|
| 2 | 2 1/8 | 4 1/8 | 3 1/8 | 3 1/8 |
| 2 1/4 | 2 5/8 | 4 1/2 | 3 5/8 | 3 1/8 |
| 2 1/2 | 2 7/8 | 5 1/8 | 3 7/8 | 3 1/2 |
| 2 5/8 | 3 | 5 1/4 | 3 7/8 | 3 1/2 |
| 2 3/4 | 3 1/8 | 5 3/8 | 3 7/8 | 3 1/2 |
| 3 | 3 1/2 | 6 1/8 | 3 7/8 | 3 1/2 |
| 3 1/4 | 3 5/8 | 6 3/8 | 3 7/8 | 3 1/2 |
| 3 1/2 | 3 7/8 | 6 5/8 | 3 7/8 | 3 1/2 |
| 3 3/4 | 4 | 7 1/8 | 3 7/8 | 3 1/2 |
| 4 | 4 1/8 | 8 1/8 | 3 7/8 | 3 1/2 |
| 4 1/8 | 4 3/8 | 8 3/8 | 3 7/8 | 3 1/2 |

DIMENSIONS (INCHES)

| A | B | C | D | E |
|-------|-------|--------|-------|-------|
| 4 1/4 | 4 7/8 | 8 3/8 | 3 7/8 | 3 1/2 |
| 4 3/8 | 5 | 8 1/2 | 3 7/8 | 3 1/2 |
| 4 1/2 | 5 1/8 | 9 1/8 | 3 7/8 | 3 1/2 |
| 4 3/4 | 5 1/4 | 9 3/8 | 3 7/8 | 3 1/2 |
| 4 7/8 | 5 3/8 | 9 1/2 | 3 7/8 | 3 1/2 |
| 5 | 5 3/4 | 10 1/8 | 3 7/8 | 3 1/2 |
| 5 1/4 | 6 | 10 3/8 | 3 7/8 | 3 1/2 |
| 5 1/2 | 6 1/8 | 10 5/8 | 3 7/8 | 3 1/2 |
| 5 3/4 | 6 3/8 | 10 7/8 | 3 7/8 | 3 1/2 |
| 6 | 6 1/2 | 11 1/8 | 3 7/8 | 3 1/2 |
| 6 1/2 | 6 3/4 | 11 3/8 | 3 7/8 | 3 1/2 |
| 7 | 7 1/2 | 12 3/8 | 3 7/8 | 3 1/2 |
| 7 1/2 | 8 | 13 3/8 | 3 7/8 | 3 1/2 |
| 8 | 8 1/2 | 14 3/8 | 3 7/8 | 3 1/2 |
| | | 15 1/4 | 3 7/8 | 3 1/2 |

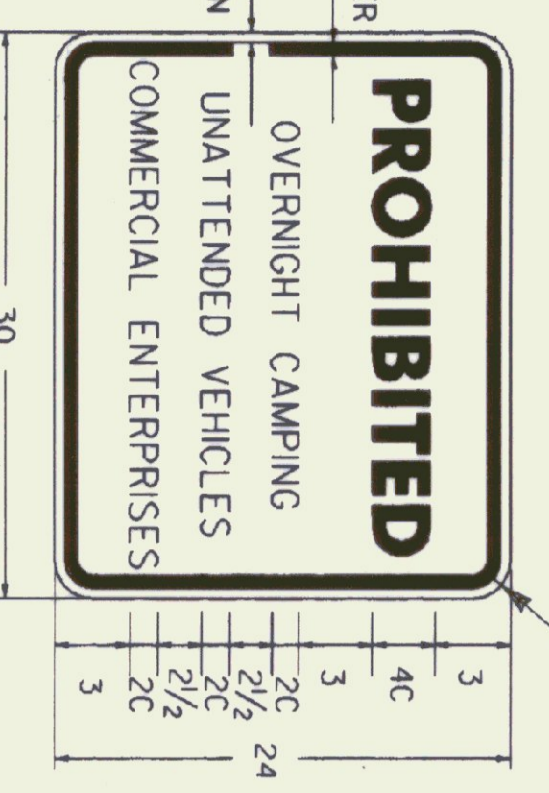

VR-032

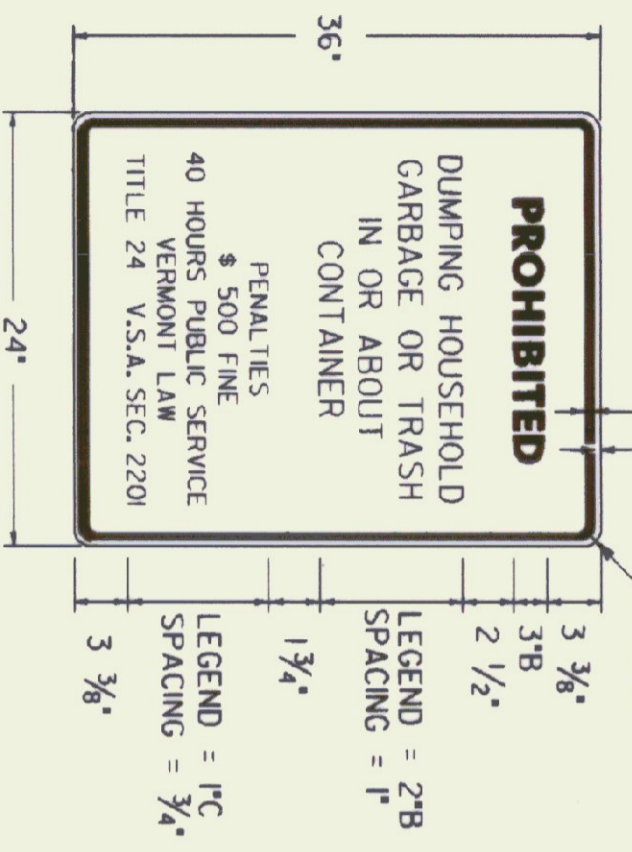

VR-278

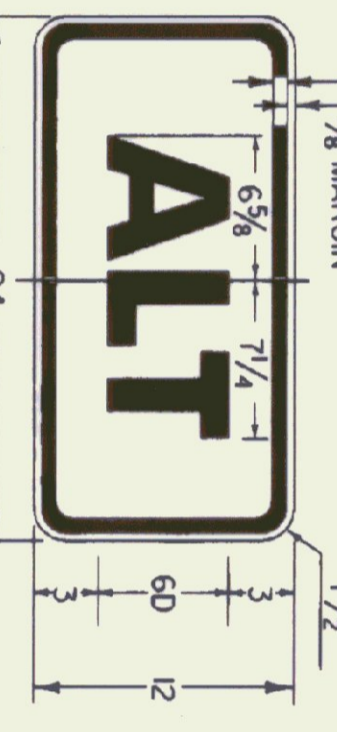

M4-1A

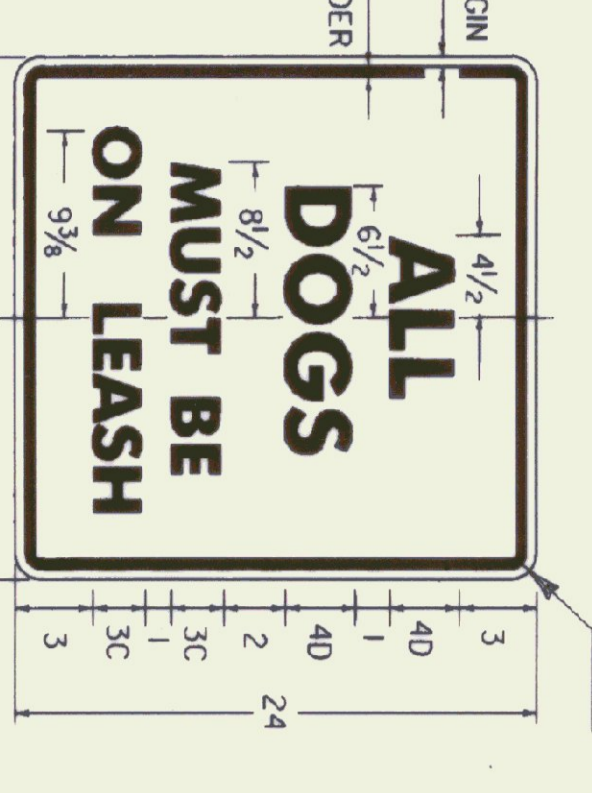

VR-648

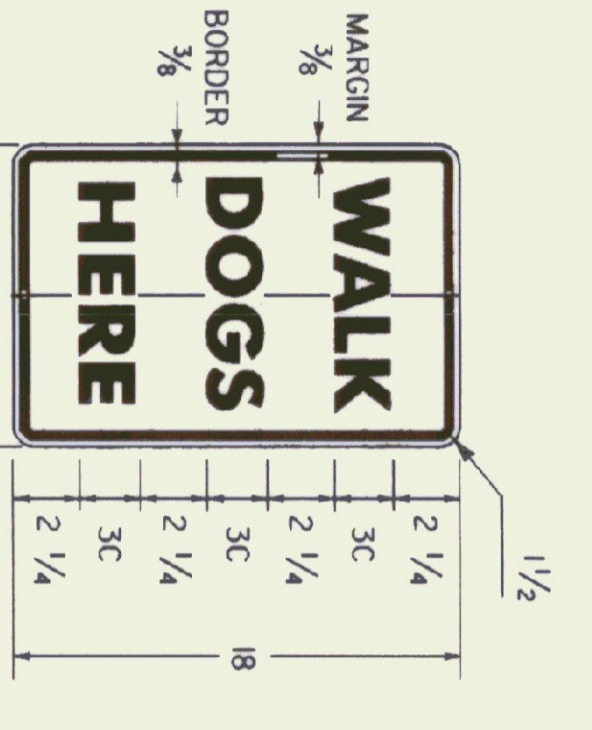

VR-541



VR-023b

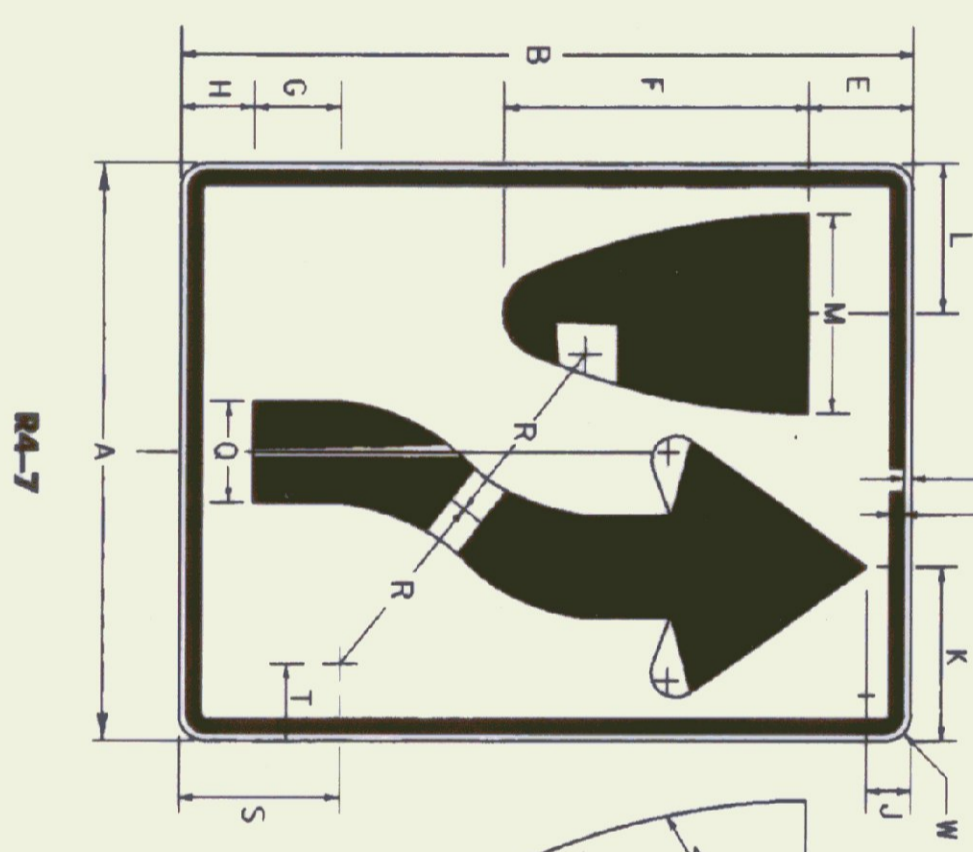

R4-7

DIMENSIONS (INCHES)

| SIGN | A | B | C | D | E | F | G | H | J | K |
|--------|--------|----|-------|-------|-------|--------|-------|-------|-------|--------|
| MIN | 18 | 24 | 3/8 | 3/8 | 3 3/8 | 9 3/8 | 1 1/8 | 2 1/4 | 1 3/8 | 5 1/2 |
| STD | 24 | 30 | 3/8 | 3/8 | 4 1/2 | 12 1/2 | 2 1/2 | 3 | 1 7/8 | 7 3/8 |
| EXPWY | 36 | 48 | 3/8 | 3/8 | 6 3/4 | 18 3/4 | 3 3/4 | 4 1/2 | 2 3/8 | 10 1/8 |
| F.W.Y. | 48 | 60 | 3/4 | 1 1/4 | 9 | 25 | 5 | 6 | 3 3/4 | 14 1/8 |
| MIN | 4 1/8 | 6 | 2 2/2 | 1/2 | 3 | 6 3/4 | 4 1/8 | 2 1/4 | 1 1/8 | 1 1/2 |
| STD | 6 1/4 | 8 | 3 | 2 | 4 | 9 | 5 1/2 | 3 | 1 3/8 | 2 1/4 |
| EXPWY | 9 3/8 | 12 | 4 1/2 | 3 | 6 | 13 1/2 | 8 1/4 | 4 1/2 | 2 | 2 3/4 |
| F.W.Y. | 12 1/2 | 16 | 6 | 4 | 8 | 18 | 11 | 6 | 2 1/8 | 3 |

GENERAL:
1. ALL DIMENSIONS IN INCHES.

COLORS:
THE REGULATORY SIGNS SHOWN ON THIS SHEET SHALL HAVE BLACK TEXT ON REFLECTORIZED WHITE BACKGROUND, UNLESS OTHERWISE NOTED. THE COLORS SHALL CONFORM WITH THE COLORS ADOPTED BY THE AMERICAN ASSOCIATION OF STATE HIGHWAY AND TRANSPORTATION OFFICIALS AND APPROVED BY THE DEPARTMENT OF TRANSPORTATION, FEDERAL HIGHWAY ADMINISTRATION.

MATERIALS:
THE SIGN BASE MATERIALS USED FOR REGULATORY SIGNS SHOWN ON THIS SHEET MAY BE ANY OF THE FOLLOWING OF THE MINIMUM THICKNESS NOTED.

| | | | |
|-------------------------------|----------|----------|----------|
| FLAT SHEET ALUMINUM | 0.060" | 0.080" | 0.100" |
| HIGH DENSITY OVERLAIN PLYWOOD | 1/2" | 5/8" | 5/8" |
| GALVANIZED FLAT SHEET STEEL | 18 GAUGE | 16 GAUGE | 14 GAUGE |

12" X 18"
18" X 24"
24" X 36"
30" X 24"
24" X 12"
24" X 30"
24" X 36"
30" X 24"
36" X 48"
48" X 60"

SPECIFICATIONS:
REGULATORY SIGNS SHALL MEET THE VERMONT STANDARD SPECIFICATIONS FOR TRAFFIC SIGNS.

TEXT DESIGN:
LETTERS, DIGITS, ARROWS, SPACING AND TEXT DIMENSIONS SHALL CONFORM WITH THE STANDARD ALPHABET FOR HIGHWAY SIGNS AND PAYMENT MARKINGS AND DESIGNS DESCRIBED IN THE STANDARD FOR HIGHWAY SIGNS AS SPECIFIED IN THE MANUAL ON UNIFORM TRAFFIC CONTROL DEVICES.

OTHER STDS.: NONE
REQUIRED

APPROVED

DIRECTOR OF PROJECT DEVELOPMENT

DIRECTOR OF CONSTRUCTION AND MAINTENANCE

REVISIONS AND CORRECTIONS

JAN. 23, 1989 - DATE OF ORIGINAL ISSUE
SEPT. 20, 1995 - ADDED AND DELETED SIGN DETAILS,
ADDED SIGN ID NUMBERS, MINOR NOTE
REVISIONS
FEB. 2, 1998 - REMOVED VR-023, REPLACED WITH
VR-278

REGULATORY SIGN
DETAILS

VERMONT AGENCY OF TRANSPORTATION
STANDARD
E-144

/rctf/std/stdel44.dgn: stdel44.i