

01 Foyer 100A  
Scale: 1/4" = 1'-0"

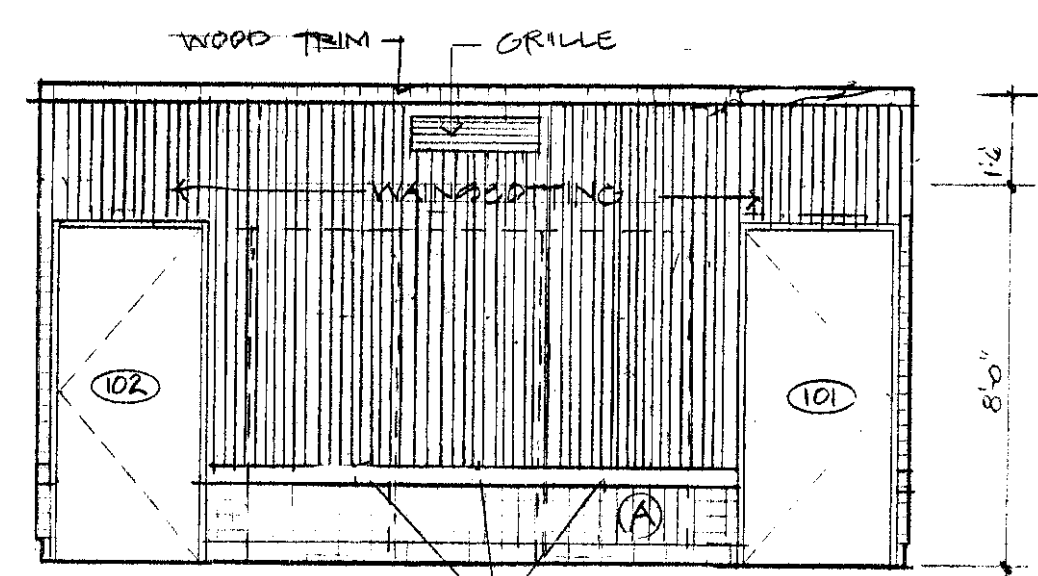

02 Foyer 100A  
Scale: 1/4" = 1'-0"

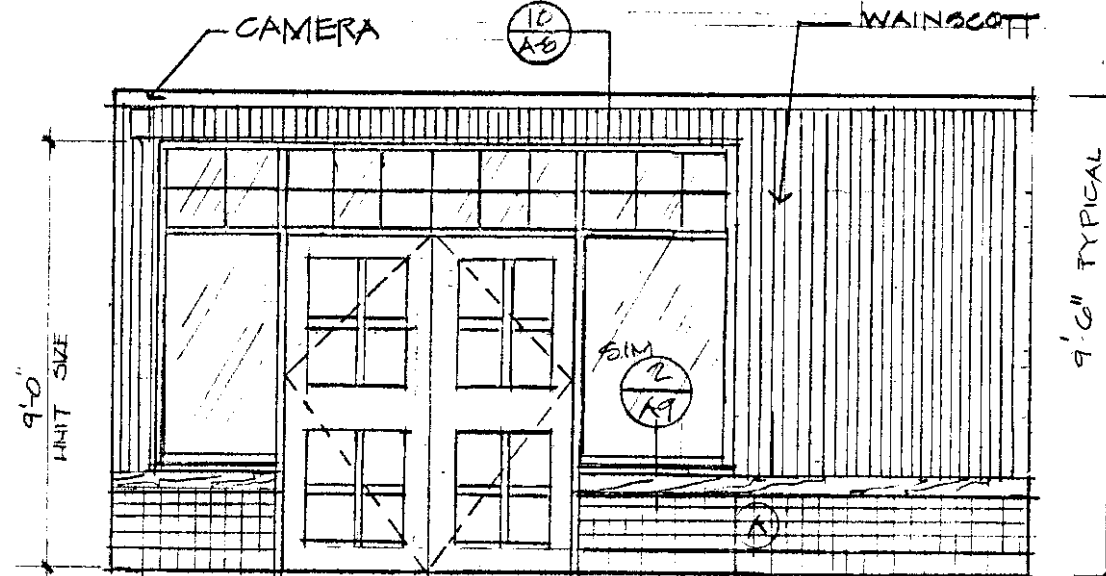

03 Foyer 100A  
Scale: 1/4" = 1'-0"

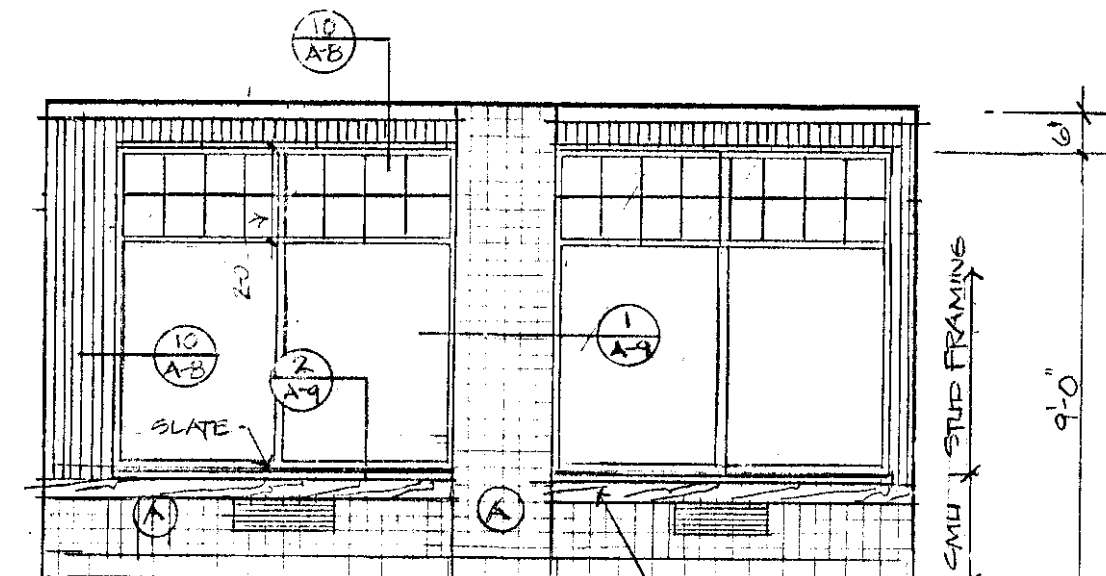

04 Foyer 100A  
Scale: 1/4" = 1'-0"

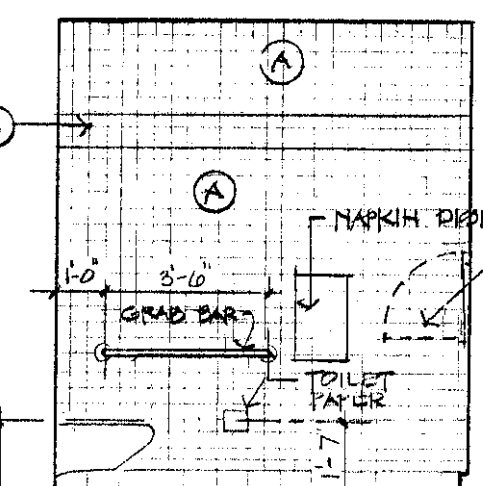

05 Restroom 101  
Scale: 1/4" = 1'-0"

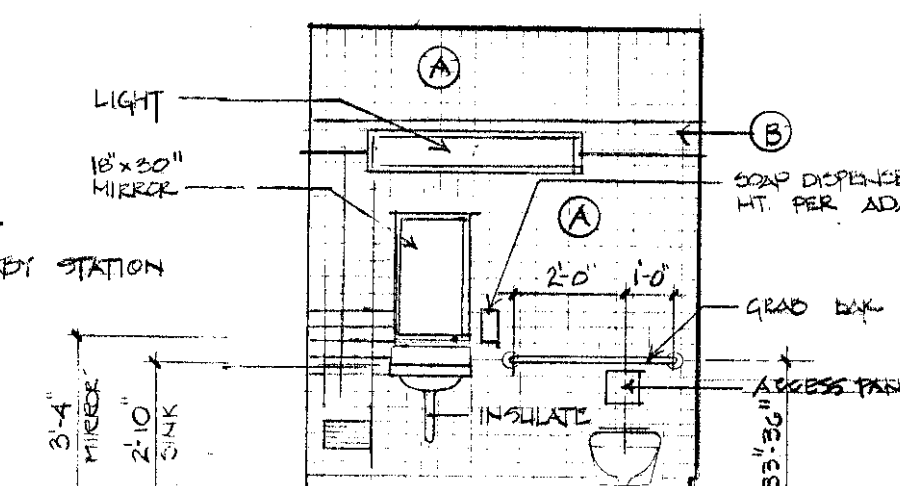

06 Restroom 101  
Scale: 1/4" = 1'-0"

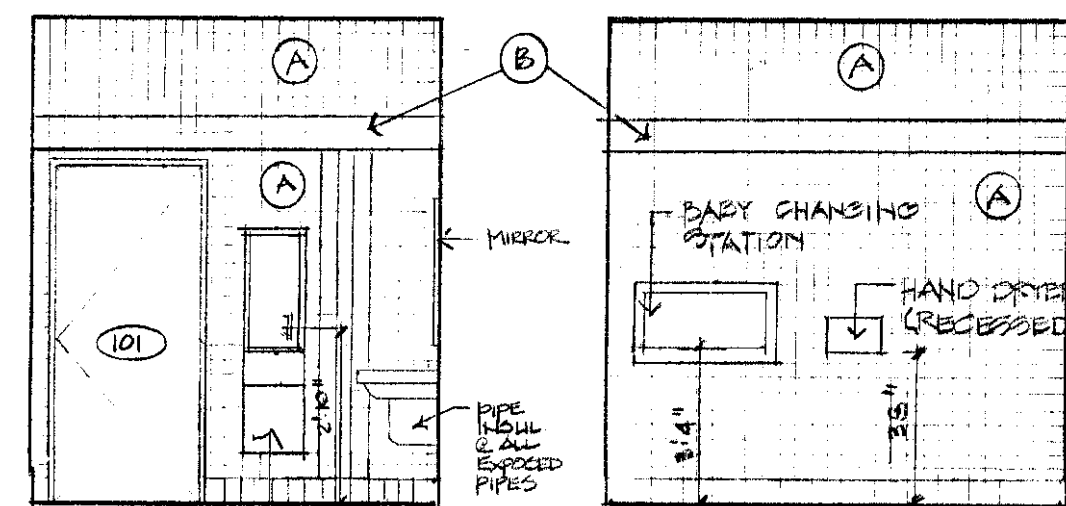

07 Restroom 101  
Scale: 1/4" = 1'-0"

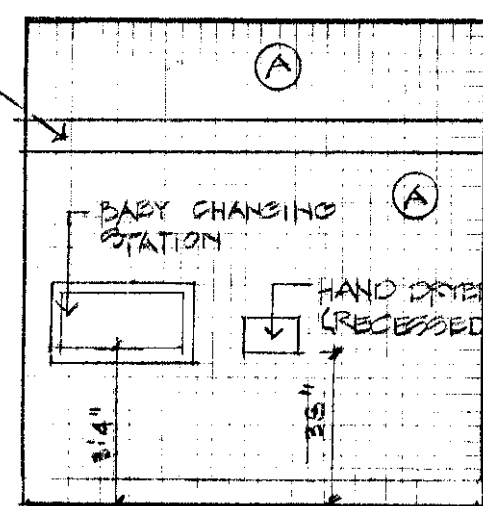

08 Restroom 101  
Scale: 1/4" = 1'-0"

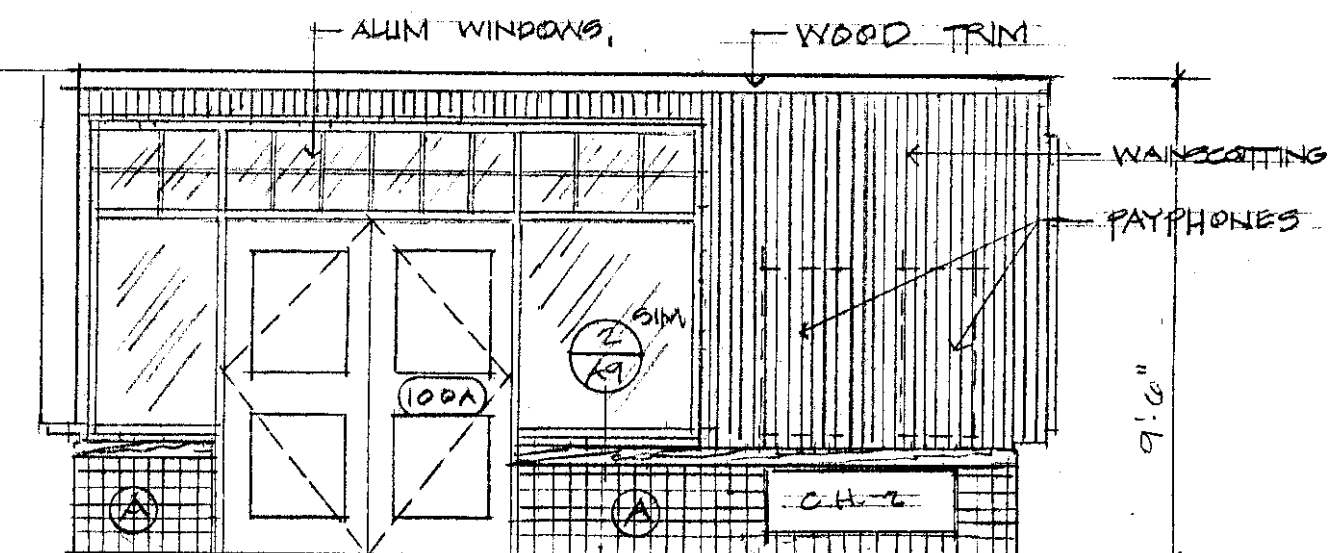

09 Entry Vestibule  
Scale: 1/4" = 1'-0"

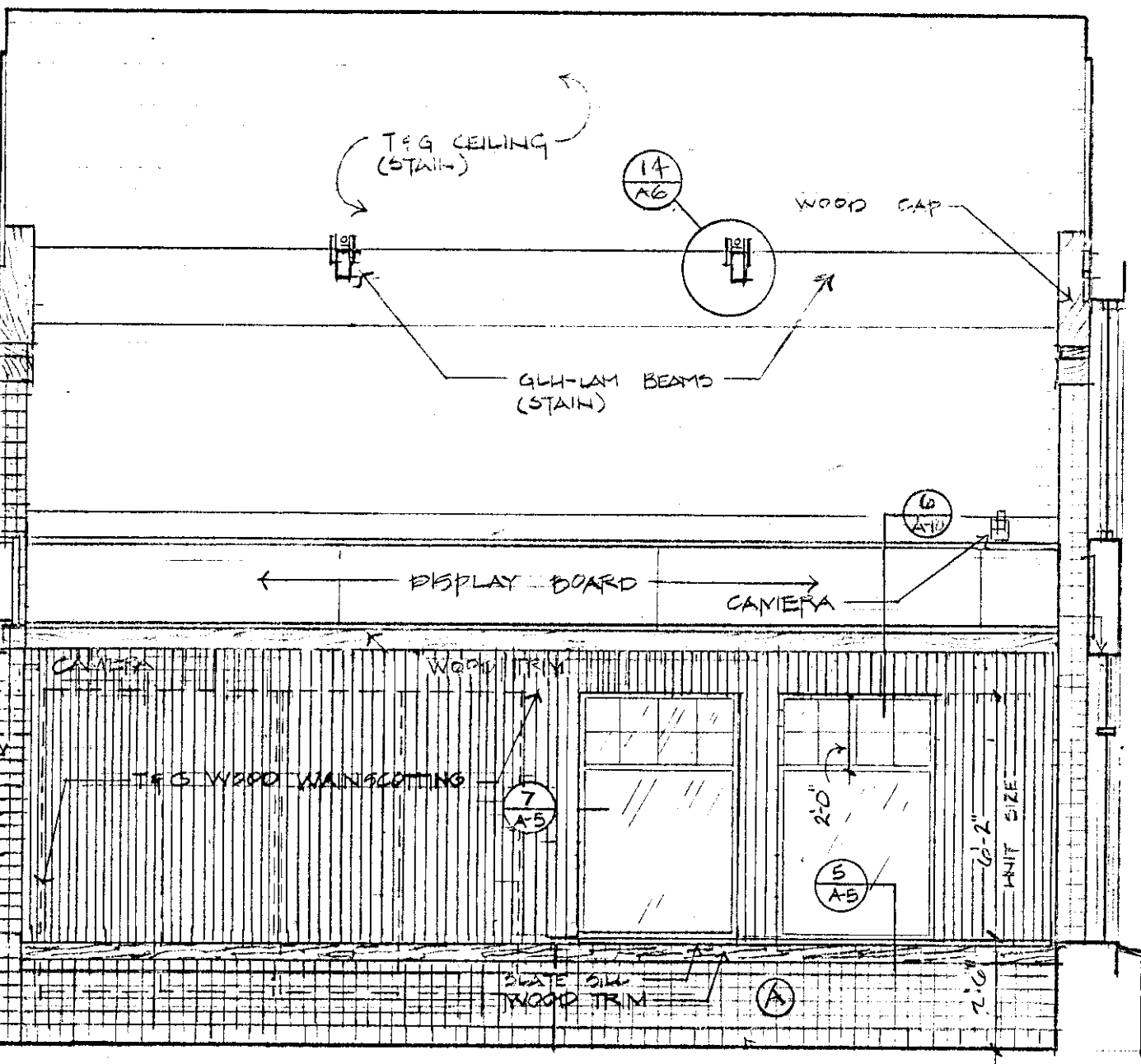

10 Display 105  
Scale: 1/4" = 1'-0"

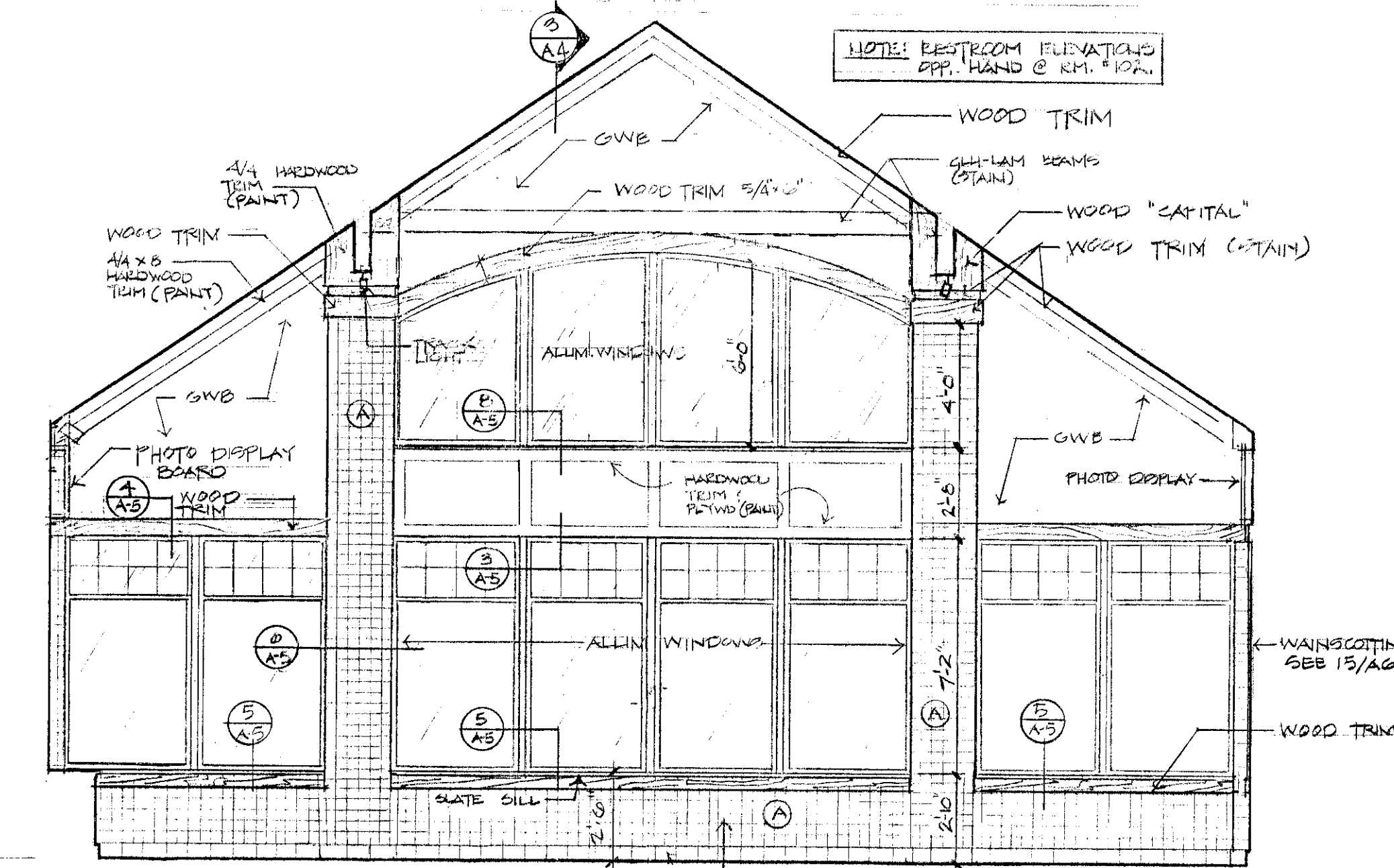

11 Display 105  
Scale: 1/4" = 1'-0"

TYPICAL MOUNTING HEIGHTS

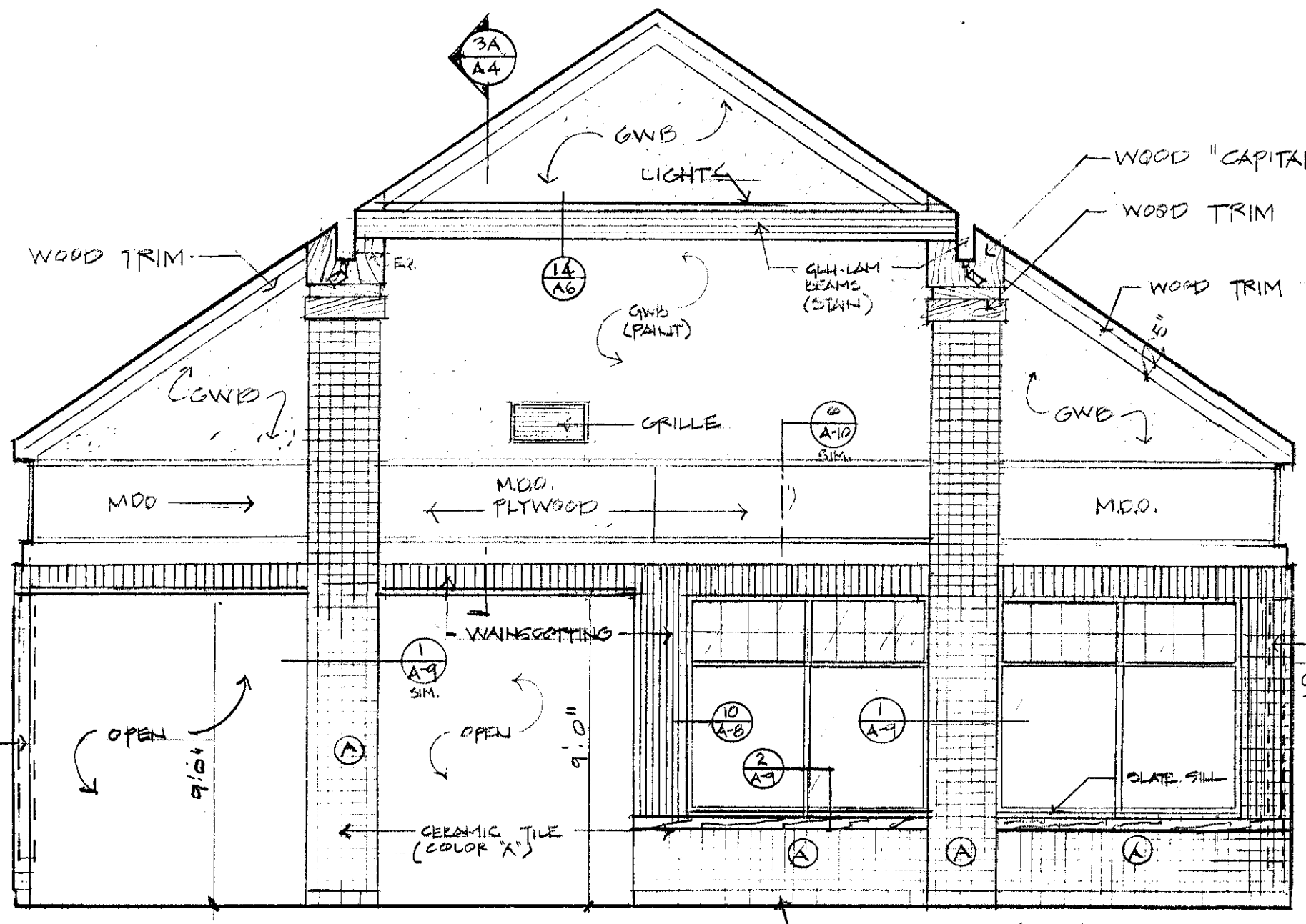
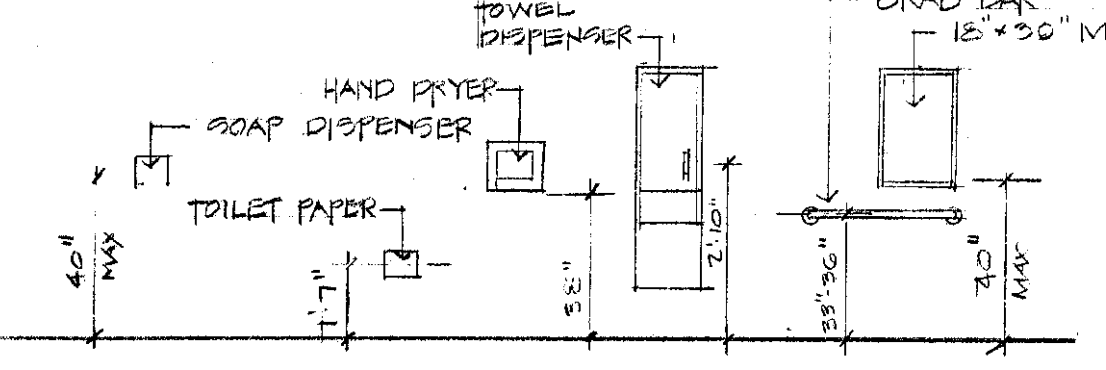

12 Display 105  
Scale: 1/4" = 1'-0"

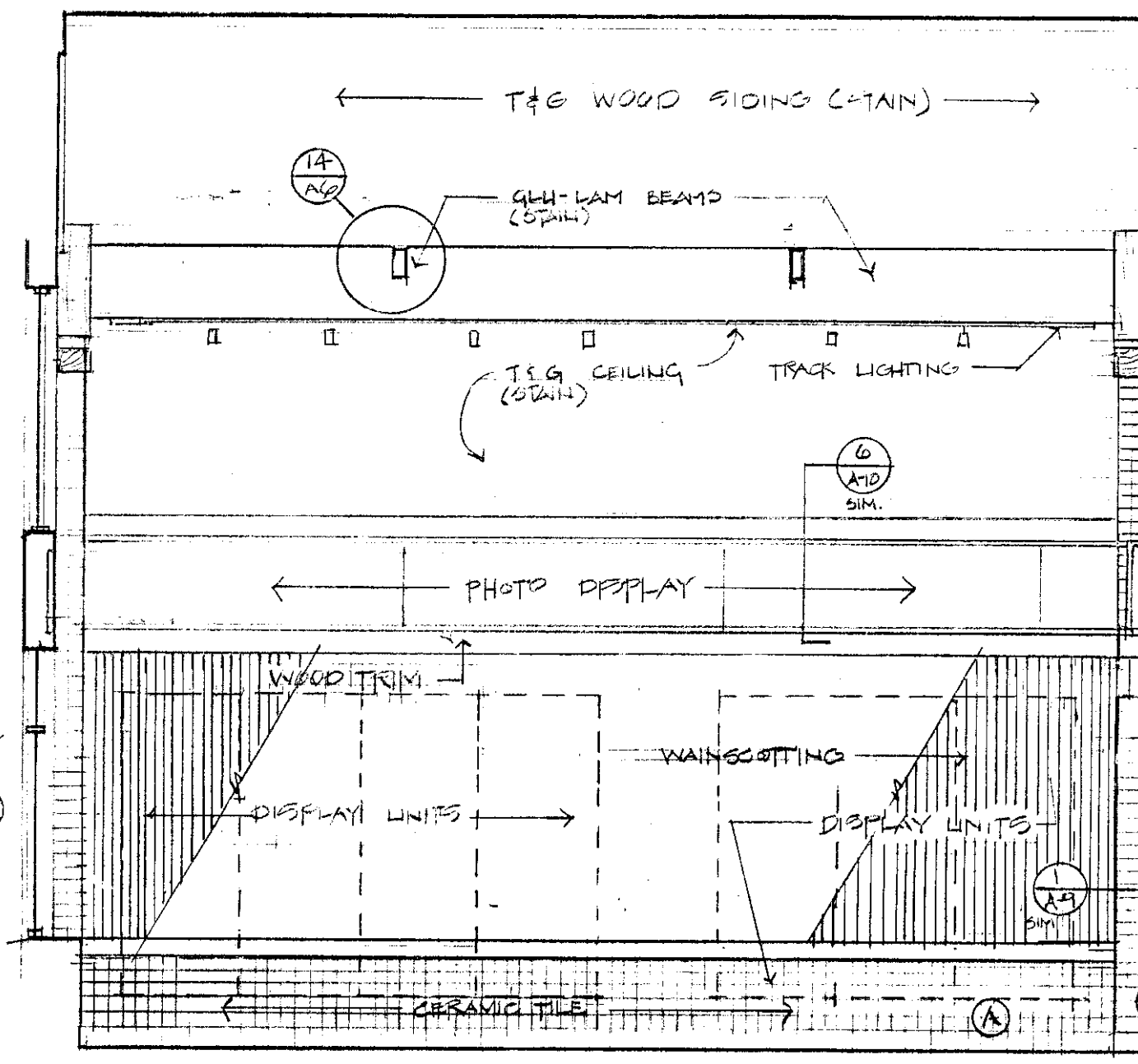

13 Display 105  
Scale: 1/4" = 1'-0"

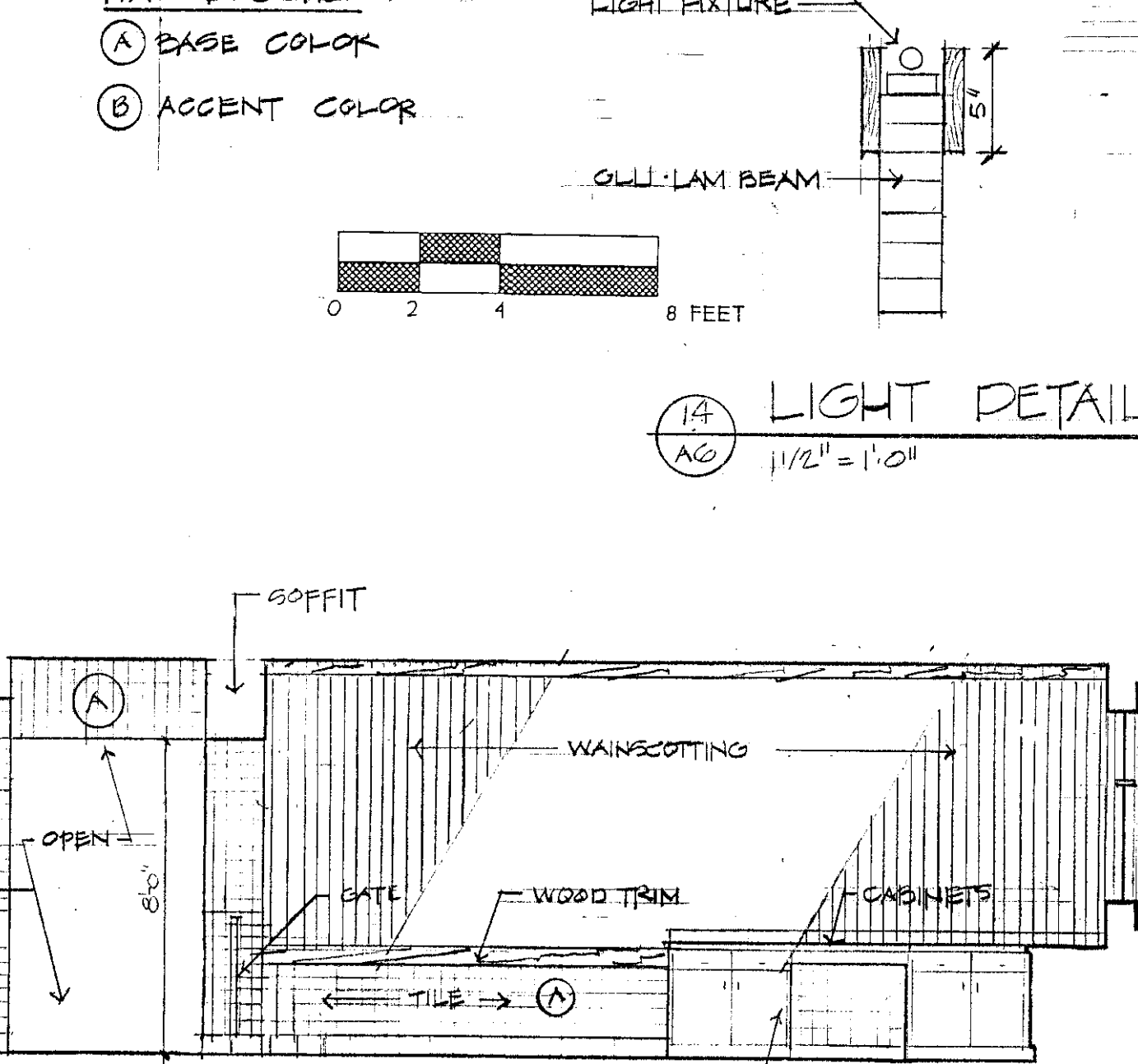

14 Attendant 103  
Scale: 1/4" = 1'-0"

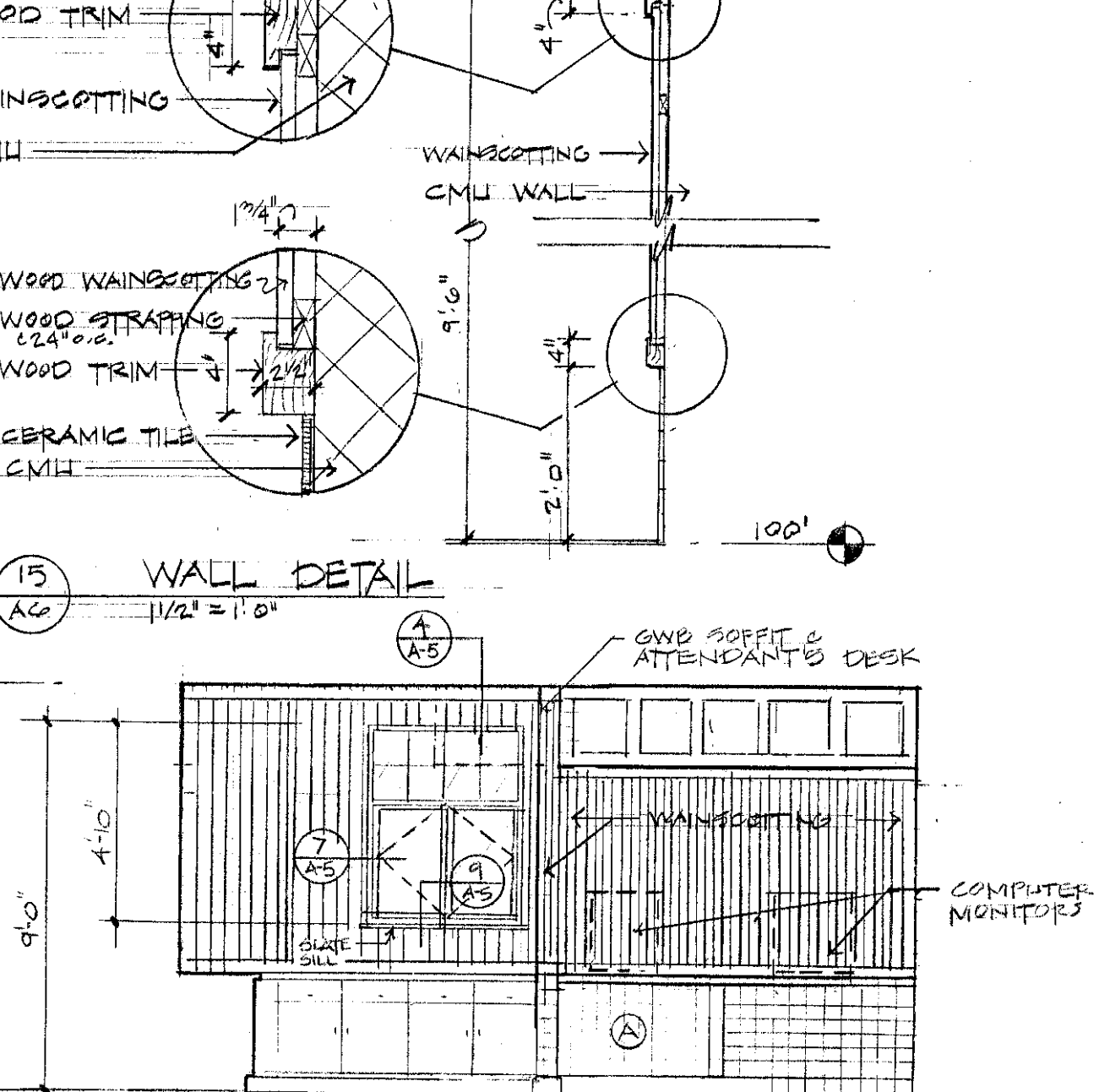

15 Attendant 103  
Scale: 1/4" = 1'-0"

TILE LEGEND  
A BASE COLOR  
B ACCENT COLOR

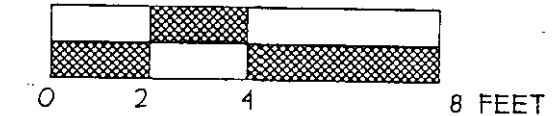

16 Light Detail  
Scale: 1/2" = 1'-0"

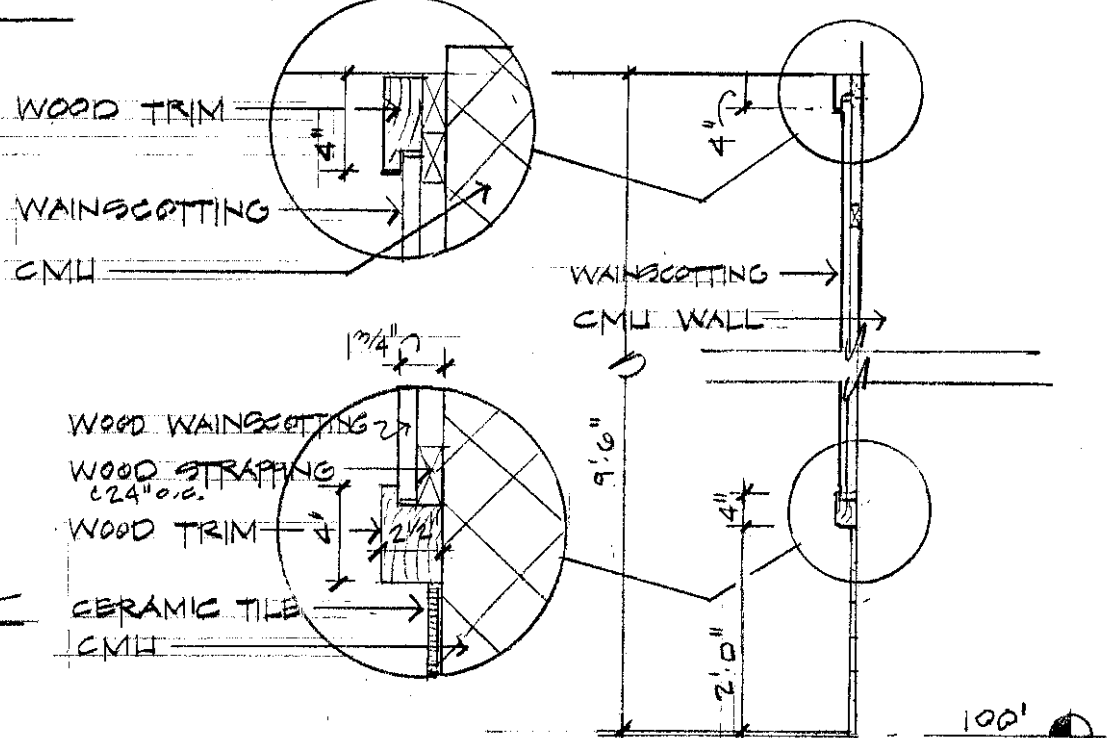

17 Wall Detail  
Scale: 1/2" = 1'-0"

