

* = REDUCE SPACING 50%

COLORS-SEE STANDARD E-100
MATERIALS-SEE STANDARD E-100

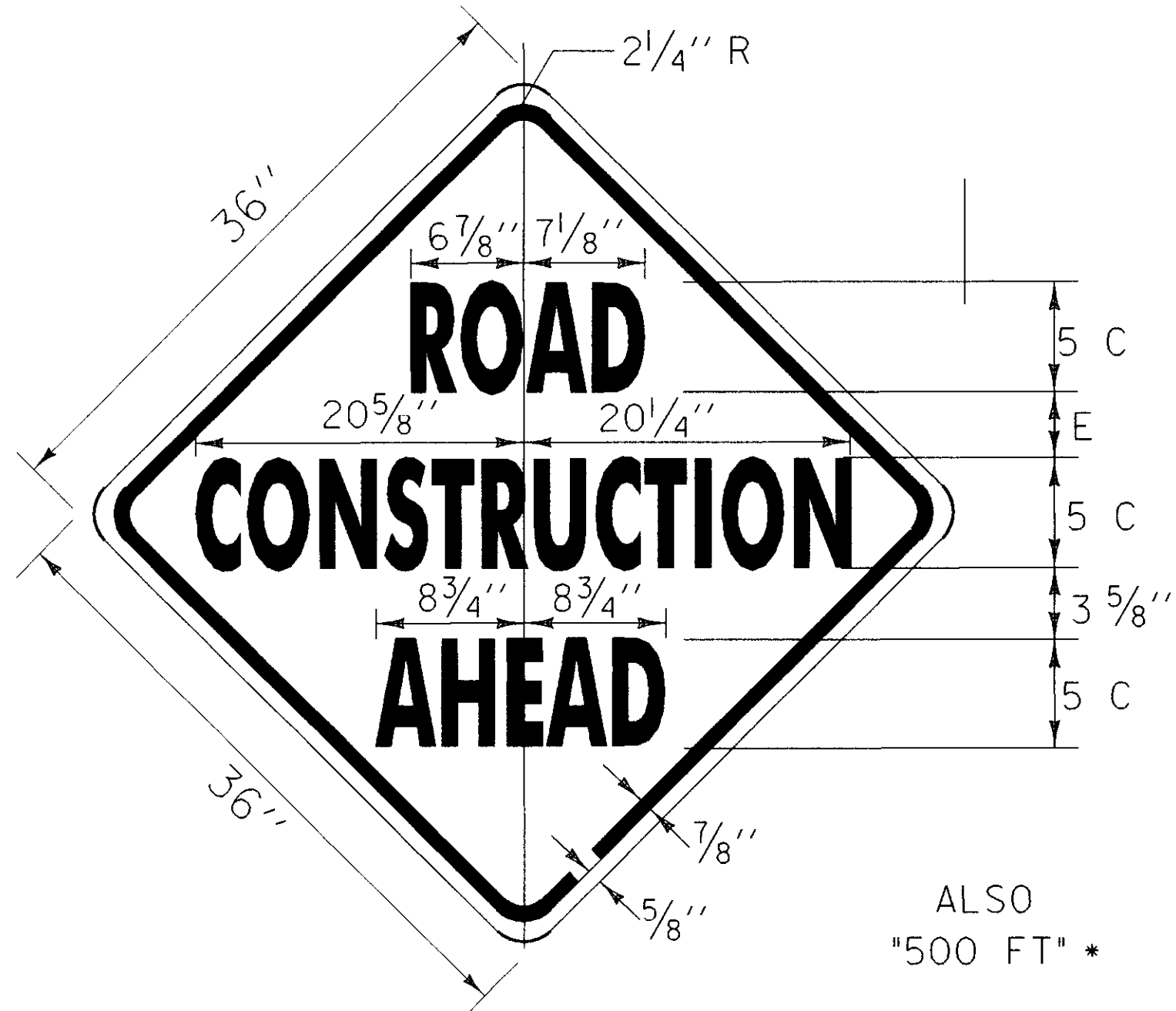

NOT TO SCALE

ALSO
"500 FT" *

* = REDUCE SPACING 50%

DIMENSIONS (INCHES)

SIGN	A	B	C	D	E	F	G	H	J	K
STD. & MIN.	24	3/8	5/8	10 1/2	8 1/2	6 1/2	6 7/8	1 3/8	1 1/2	1

COLORS
CIRCLE AND DIAGONAL - RED (REFL.)
SYMBOL, BORDER, LEGEND - BLACK (NON-REFL.)
BACKGROUND - WHITE (REFL.)

MATERIALS
SEE STD. E-144

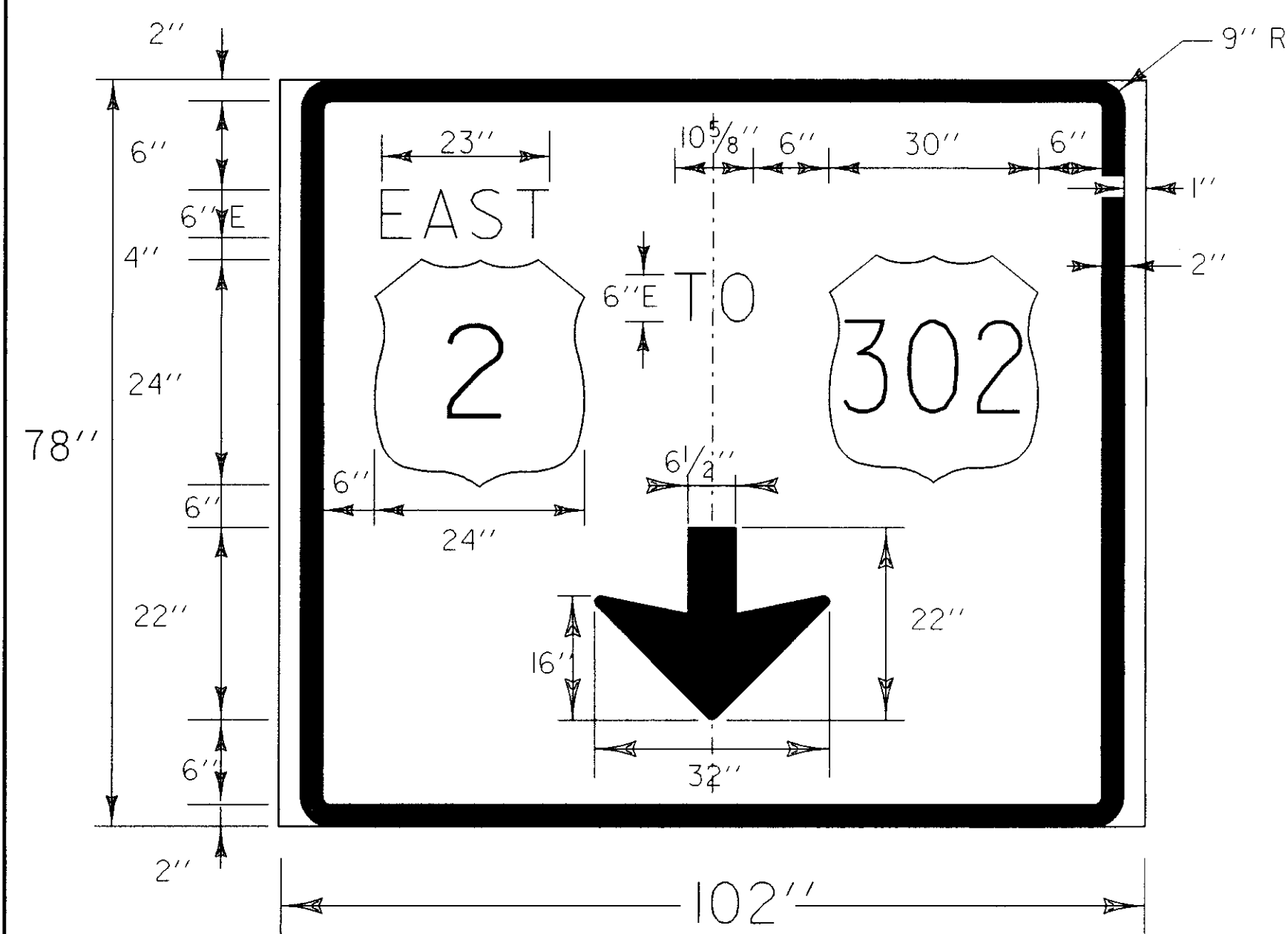
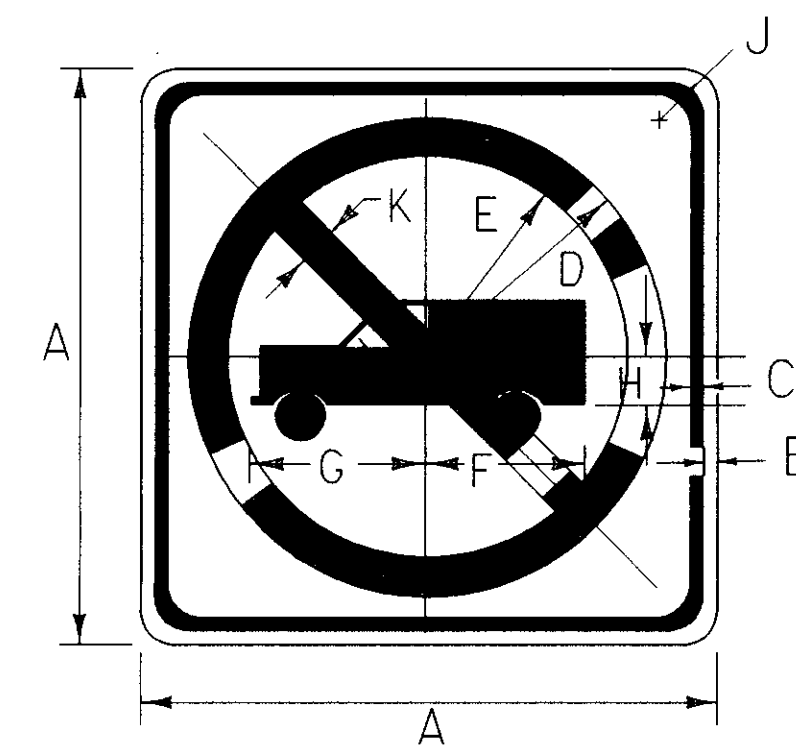

(ENCAPSULATED LENS)
MATERIALS, EXTRUDED ALUMINUM PANELS
COLORS
LEGEND, BORDER AND ARROW - WHITE
BACKGROUND - GREEN

NOT TO SCALE

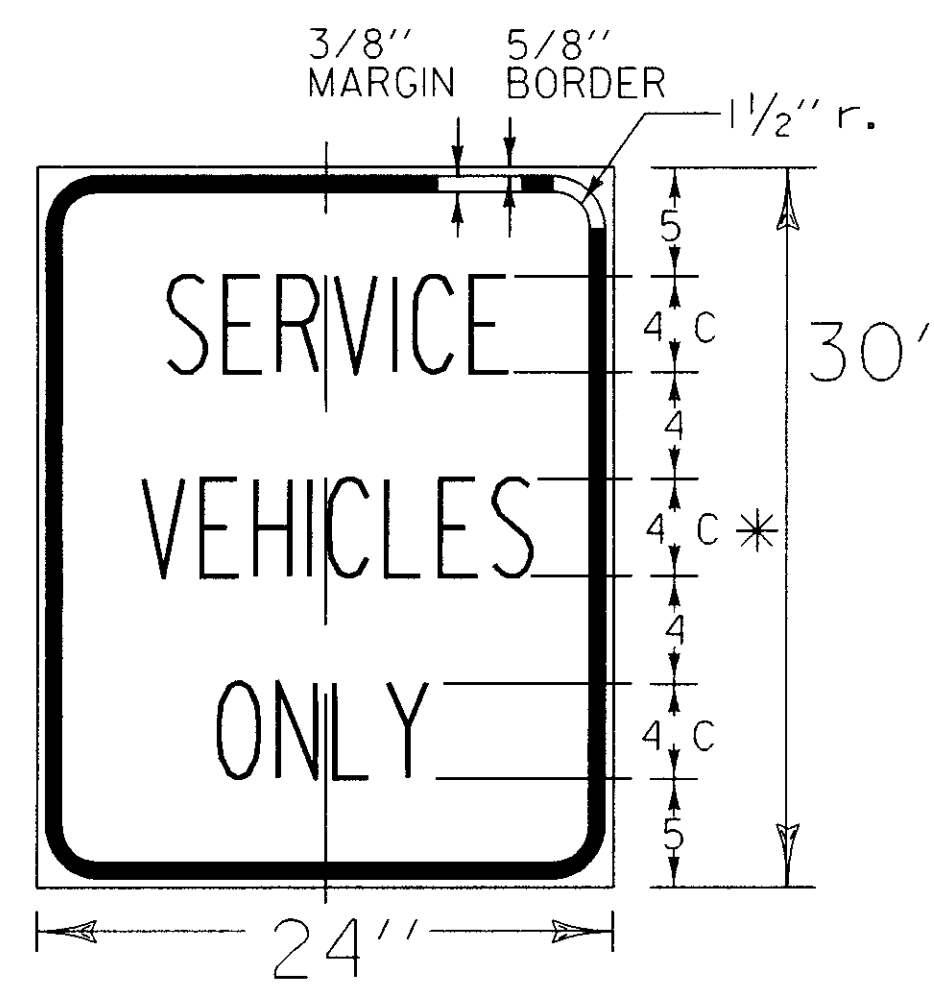
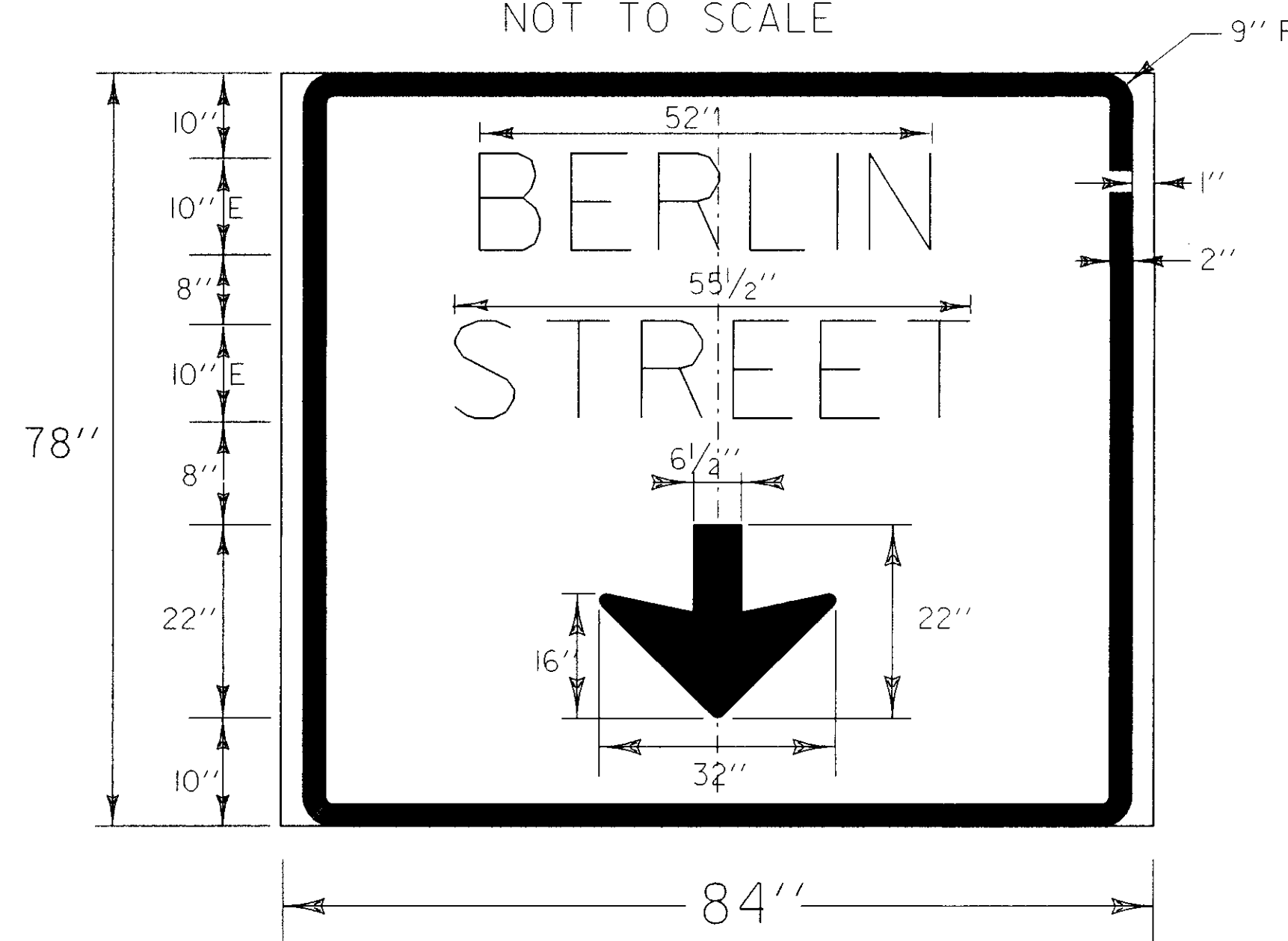

* REDUCE SPACING 50%

MATERIALS
SEE STD. E-141
LEGEND - BLACK (NON-REFL.)
BACKGROUND - WHITE (REFL.)

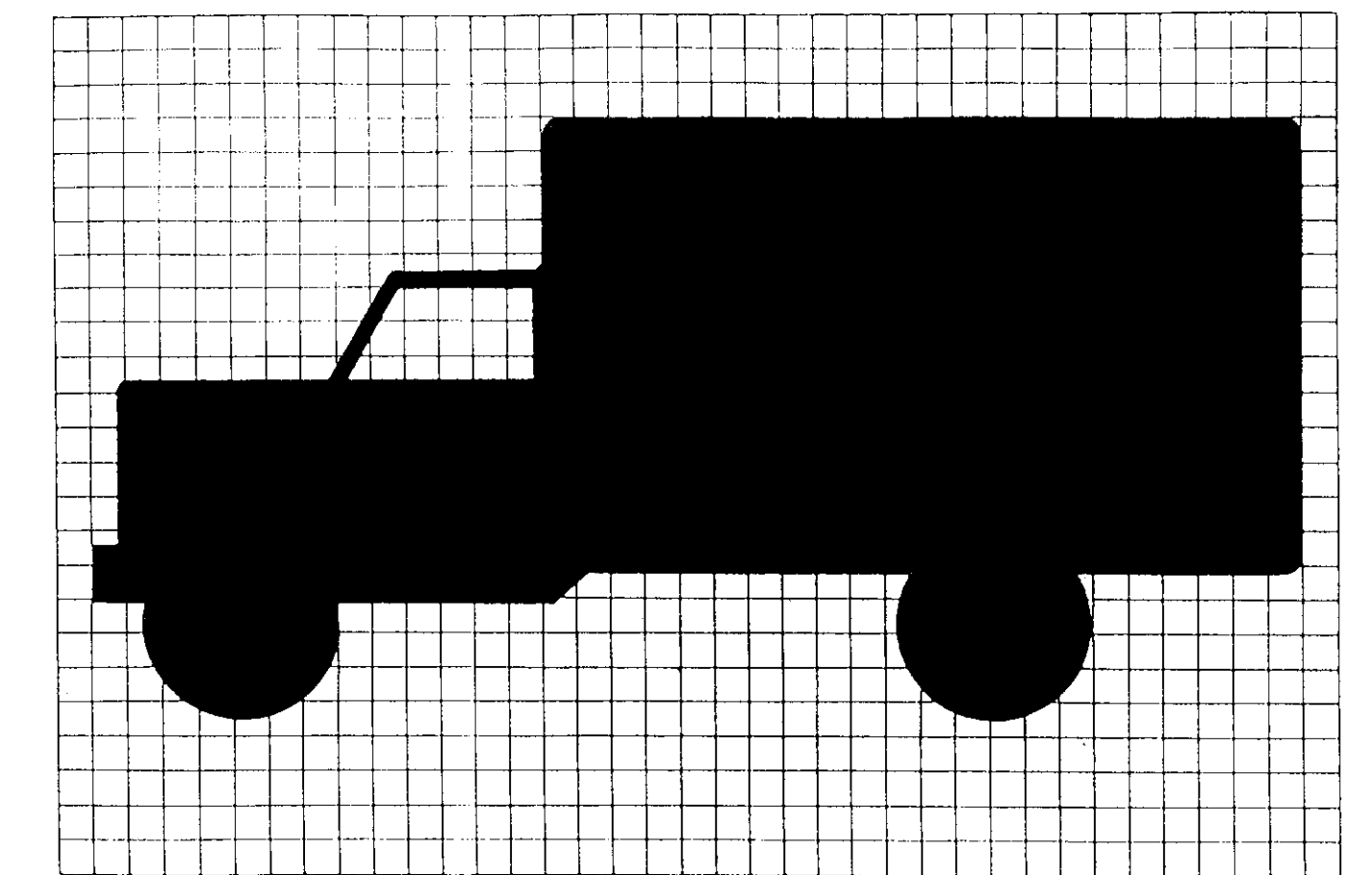

TRUCK SYMBOL DETAIL (DIMENSIONS IN INCHES)

A	B	C	D	E	F	G	H	J	K
26 1/4	-	-	13 1/8	10 5/8	8 1/8	8 1/2	1 5/8	-	2 1/2

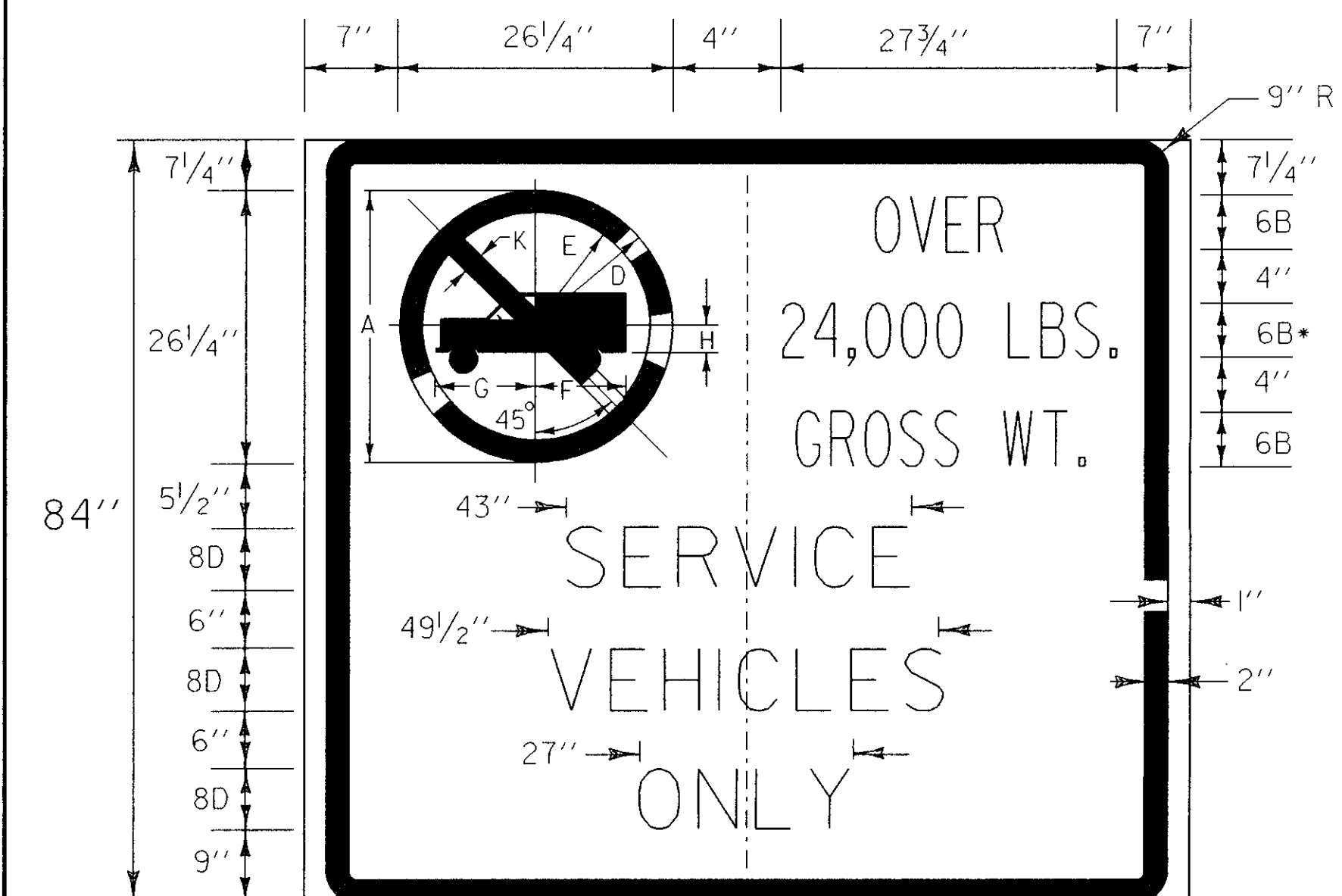

(ENCAPSULATED LENS)
MATERIALS, EXTRUDED ALUMINUM PANELS
COLORS
(SYMBOL) CIRCLE AND DIAGONAL = RED
LEGEND = BLACK
BACKGROUND = WHITE
NOT TO SCALE

+ REDUCE
SPACING 40%

ARCHIVED
ON CADD

SURVEYED BY	N/A	DATE	N/A
DRAWN BY	COTA	DATE	2-22-90
SQUAD LEADER	SHERIDAN		
DESIGN FILE NO.	PETED.DGN		
PRF FILE	76B033DTL.PRF	DATE PLOTTED	
PROJ. NAME	MONTPELIER, BERLIN ST.		
PROJ. NO.	MEGC-M6400 (7)		
SHEET 133	OF 335	SHEETS	