

DIMENSIONS (INCHES)											
SIGN	A	B	C	D	E	F	G	H	J	K	L
STD.	30	1/4	1/4	5/8	3	3/4	5-3/16	5-5/8	13-1/16	13-1/16	1-7/8
FWY.	48	3/4	1-1/4	8/8	5	1-1/4	8-1/4	9	21-7/8	20-7/8	3

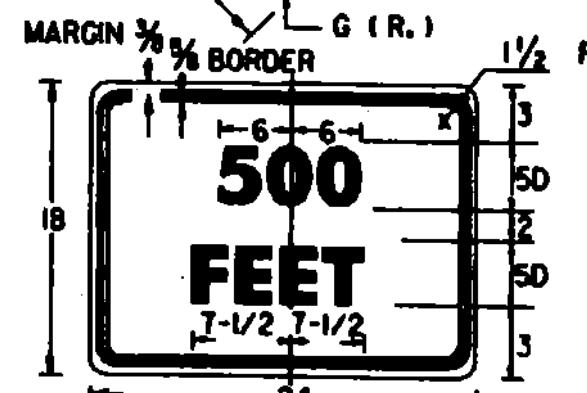

DIMENSIONS (INCHES)							
SIGN	A	B	C	D	E	F	G
STD.	36	3/4	3/4	2-3/4	13-1/2	14-5/8	2-1/4
FWY.	48	3/4	1-1/4	3-3/4	18	19-1/2	3

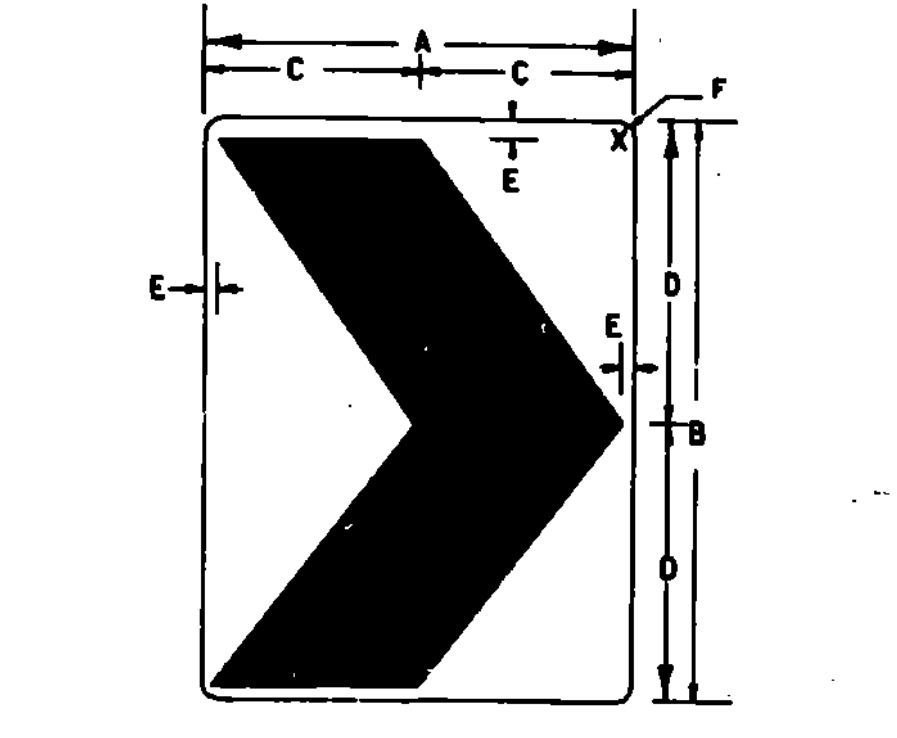
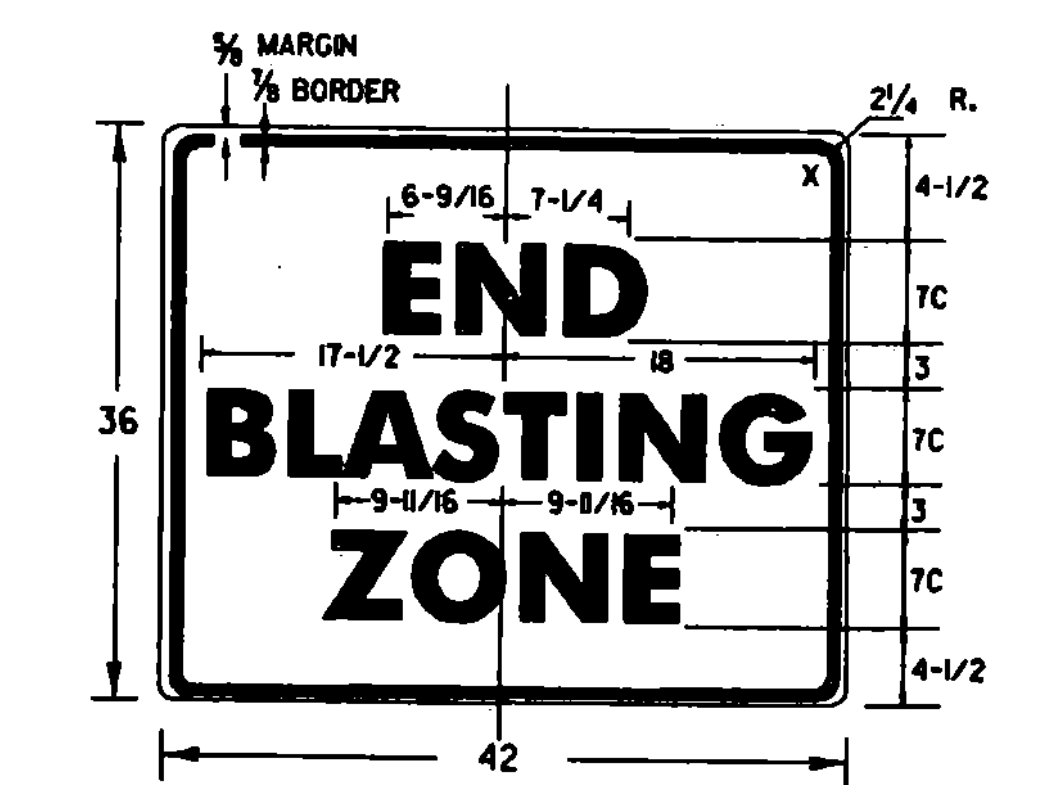
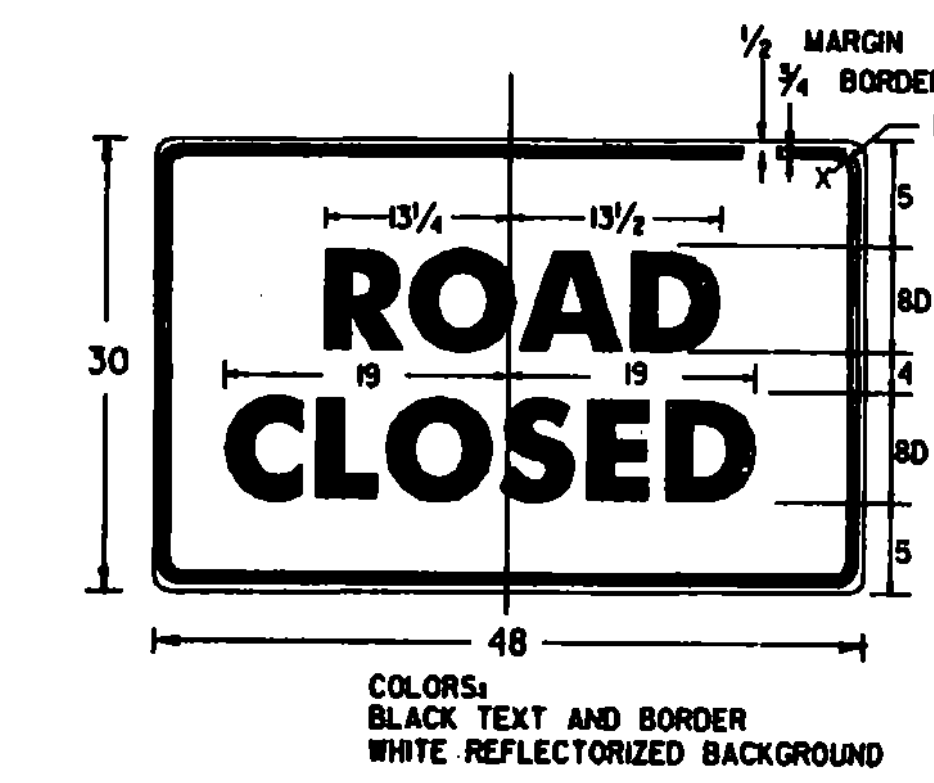
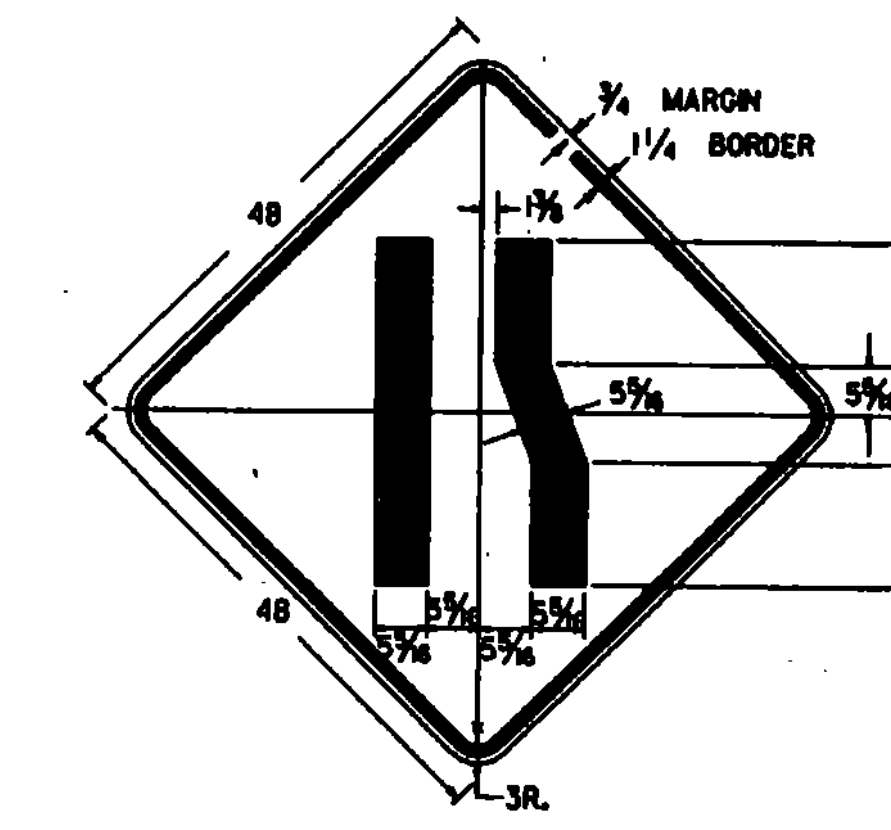
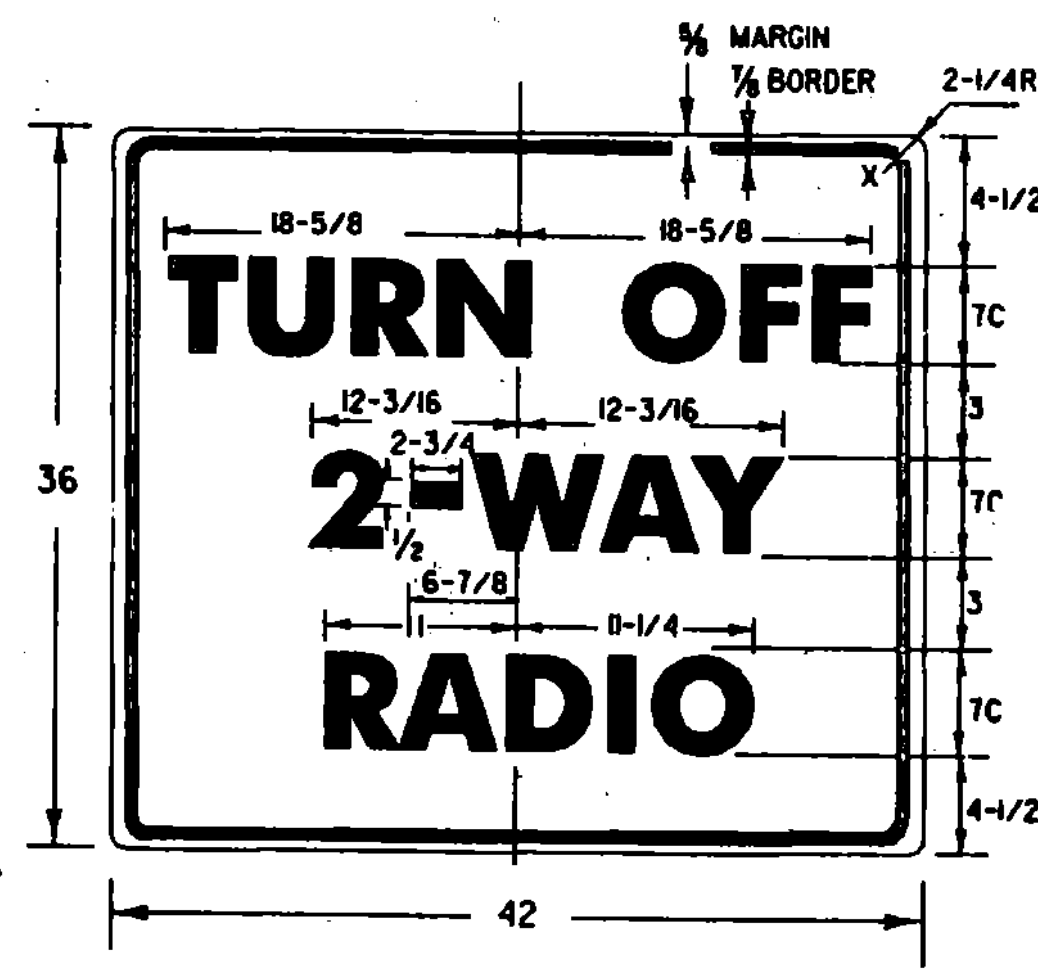
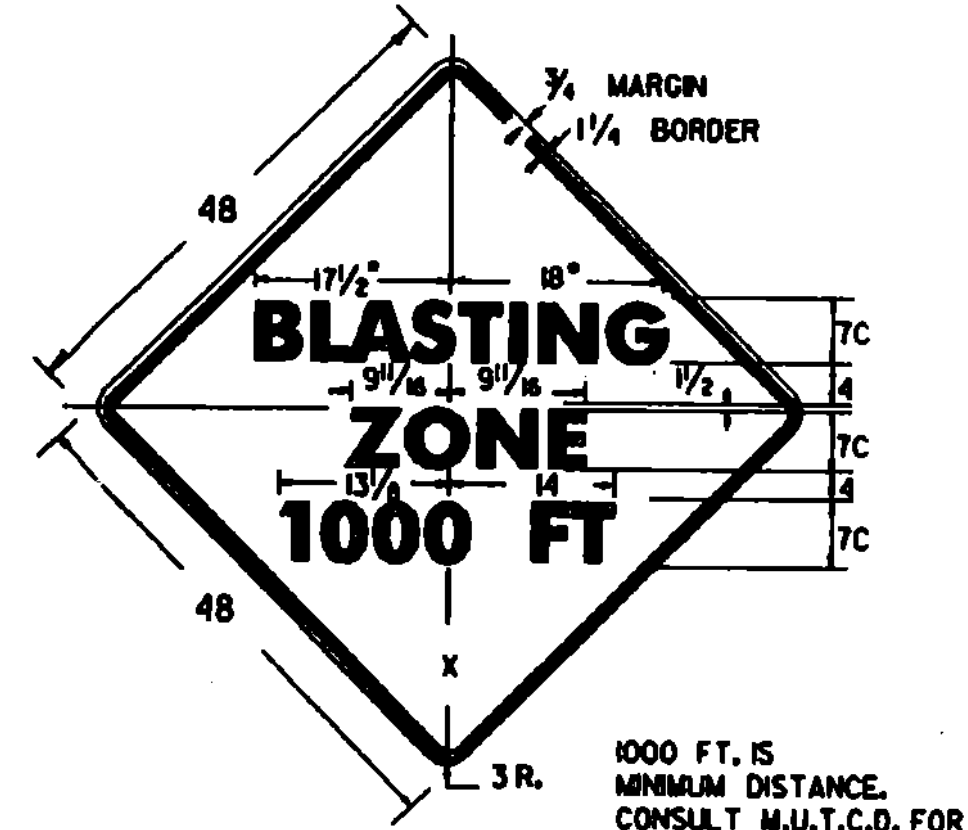
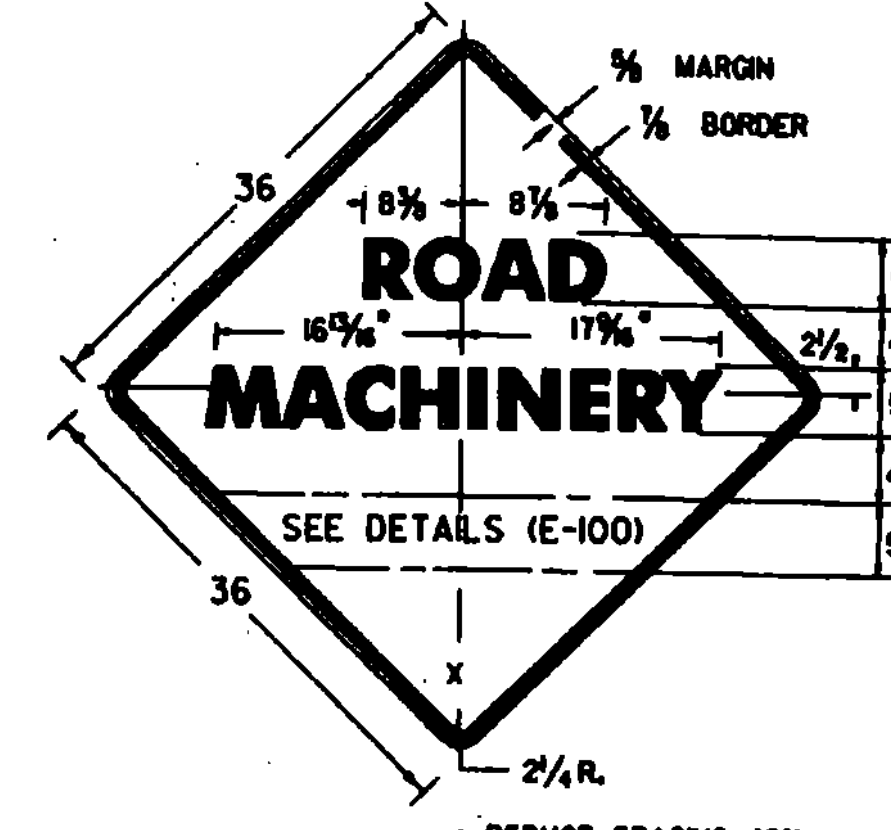
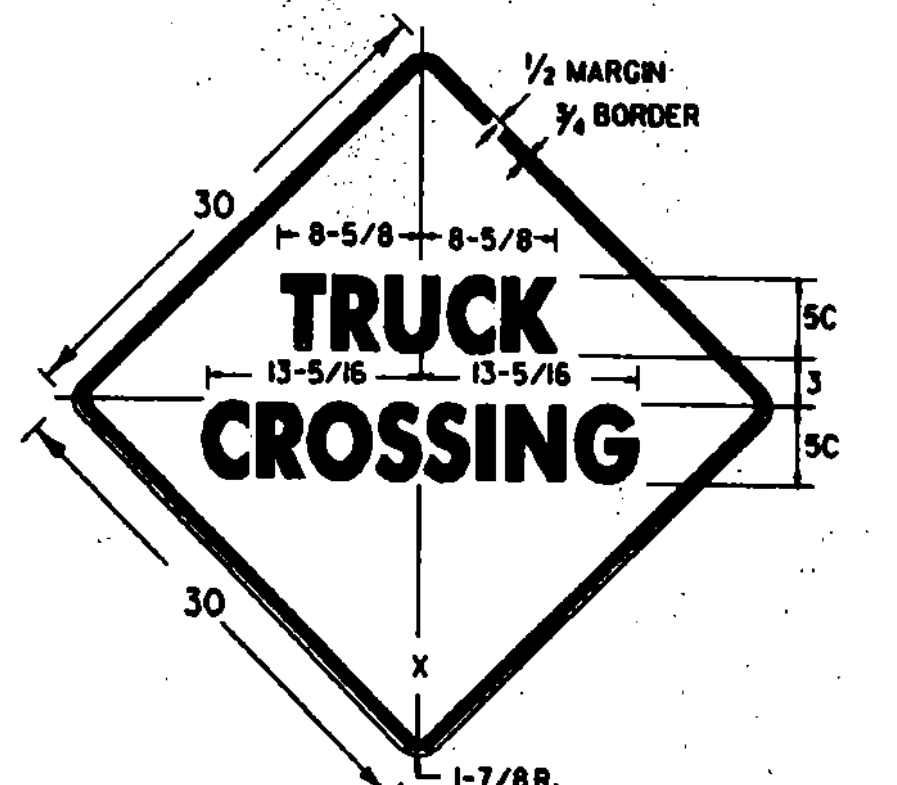
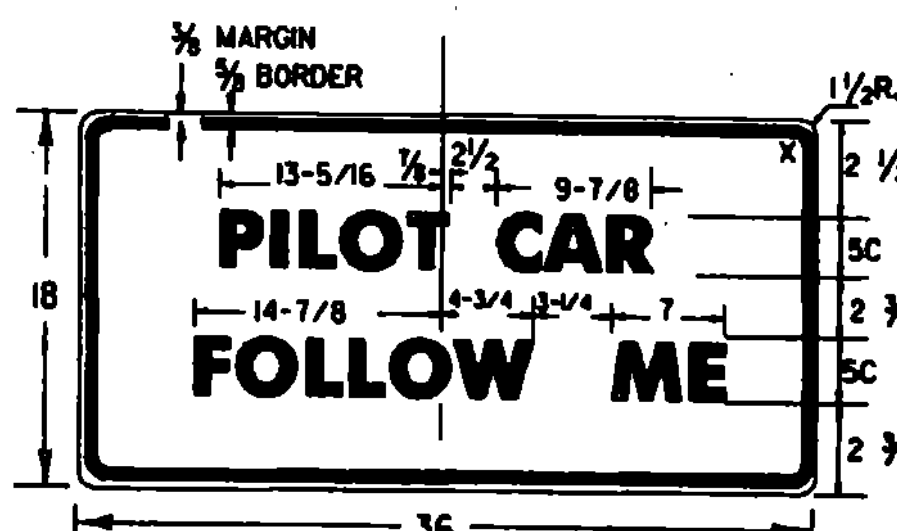

DIMENSIONS (INCHES)						
SIGN	A	B	C	D	E	F
STD.	18	24	9	12	3/4	1-1/2
SPECIAL	24	30	12	15	3/4	1-1/2
EXPWY.	30	36	15	18	1	1-7/8
FRWY.	36	48	18	24	1-1/8	2-1/4

COLORS:  
CHEVRON -BLACK  
BACKGROUND-YELLOW(REFL.)

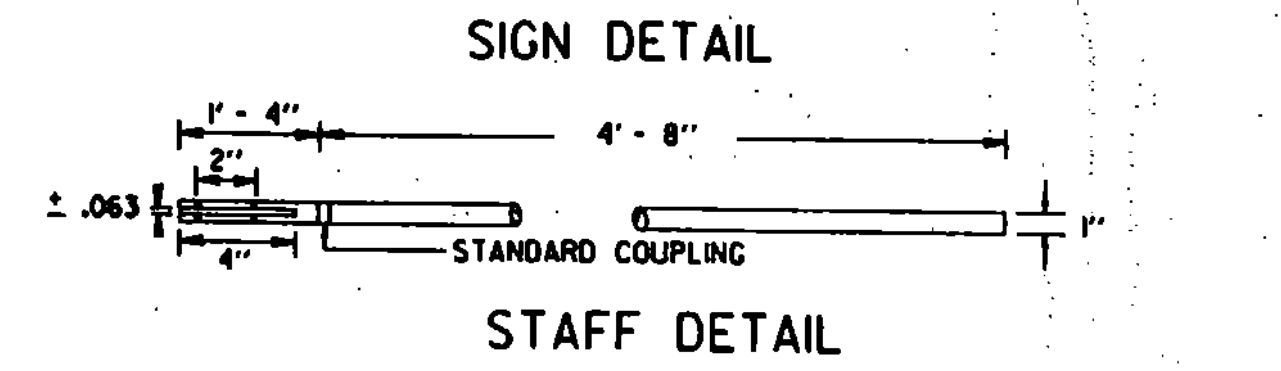
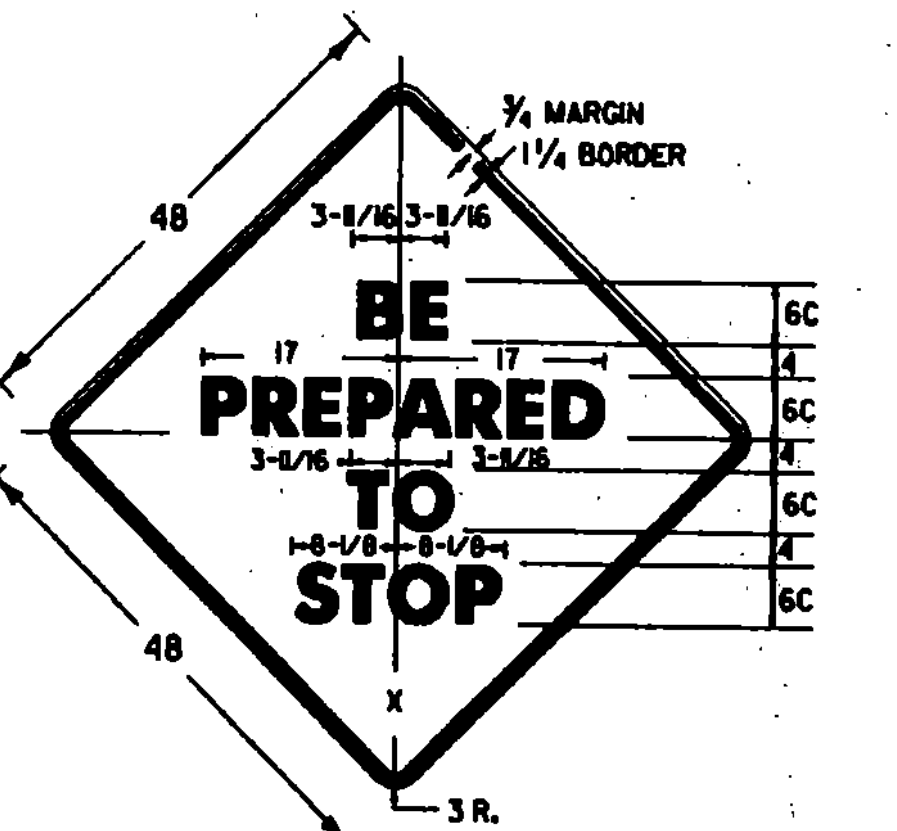

MATERIALS:  
THE SIGN MATERIALS SHALL BE 0.063" ALUMINUM WITH COLORS AS INDICATED ON DETAILS.  
THE STAFF SHALL BE RIGID ALUMINUM CONDUIT OR TUBING WITH A WALL THICKNESS OF 0.125".  
MOUNTING:  
THE STAFF SHALL BE MOUNTED WITH EITHER TWO 1/4" DIAMETER ALUMINUM BOLTS OR TWO 1/4" DIAMETER ALUMINUM RIVETS.

SIGN PADDLE FOR FLAGPERSON

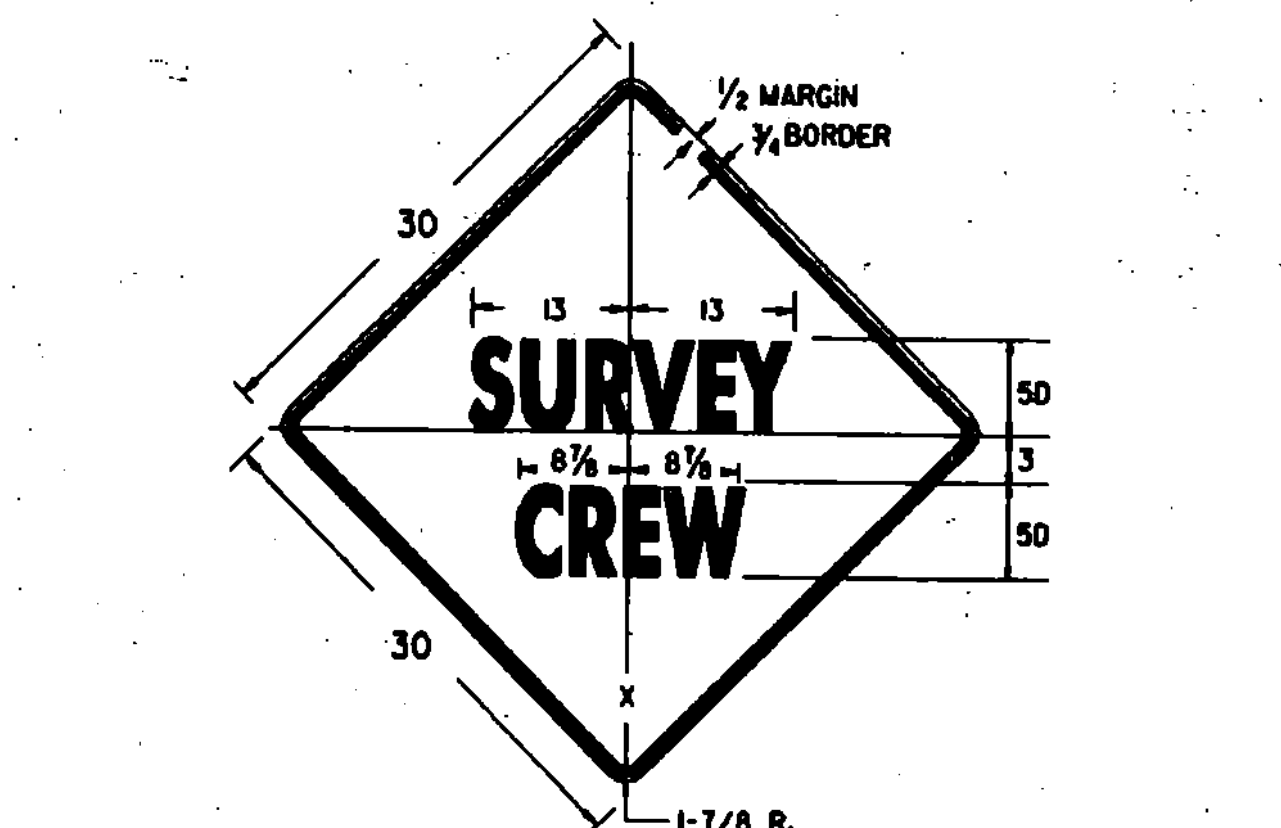

( ALL DIMENSIONS ARE IN INCHES )

NOTES  
SEE STANDARD SHEET E-100 FOR NOTES AND TEXT DETAILS.  
COLORS FOR SIGNS SHOWN ON THIS SHEET SHALL BE BLACK TEXT, BORDER AND SYMBOLS ON A REFLECTORIZED (ENCAPSULATED LENS) ORANGE BACKGROUND, UNLESS OTHERWISE NOTED. THE EXCEPTIONS ARE THE CHEVRON, ROAD CLOSED, AND PADDLE SIGNS. SIGN DETAILS INDICATE THE APPROPRIATE COLOR.  
EXISTING "BRIDGE" SIGNS MAY BE USED UNTIL THE SIGN NEEDS REPLACEMENT. NEW SIGNS SHALL SHOW REFERENCE TO "ROAD" CONSTRUCTION, HOWEVER, SIGN TEXT SHALL BE CONSISTENT THROUGHOUT THE PROJECT.  
SIGNS USED ONLY FOR DAYTIME MAINTENANCE OPERATIONS DO NOT NEED TO BE REFLECTORIZED, HOWEVER, THESE SIGNS SHALL BE LABELED "DAYTIME USE ONLY" ON THE BACK OF THE SIGN PANEL WITH 3" SERIES C LETTERS.

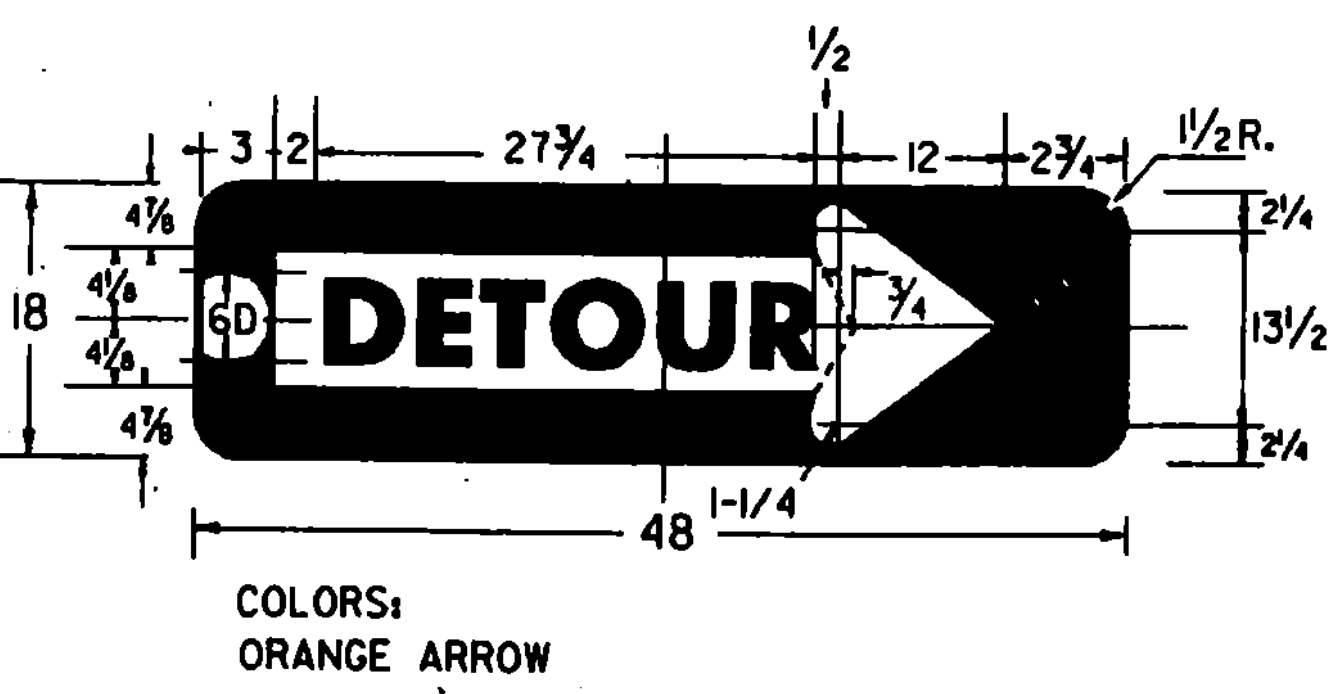

REVISIONS AND CORRECTIONS

APPROVED

OCT. 30, 1987  
DATE

David W. Kelley  
CHIEF ENGINEER

Arthur J. Goss  
DIRECTOR OF PLANNING  
AND PRE-CONSTRUCTION

William B. MacArthur  
TRAFFIC AND SAFETY ENGINEER

# CONSTRUCTION SIGN DETAILS

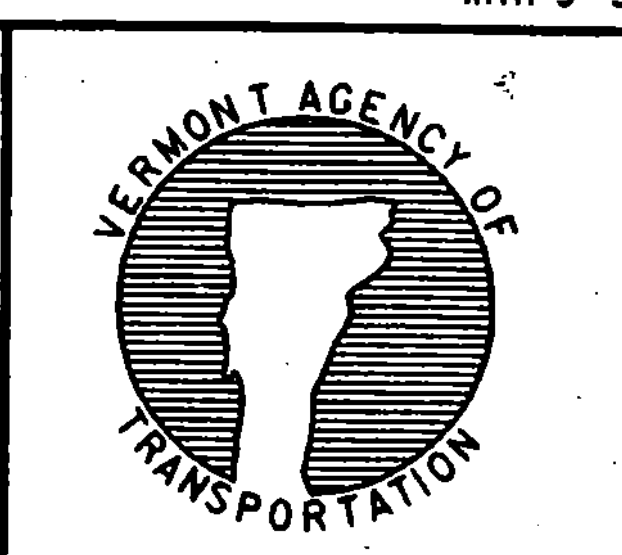

# STANDARD E-101