

1.50" RADIUS, 0.50" BORDER, 0.00" INDENT
 COLORS: LEGEND - WHITE
 BACKGROUND - GREEN
 TEXT STYLE: C

D3-1

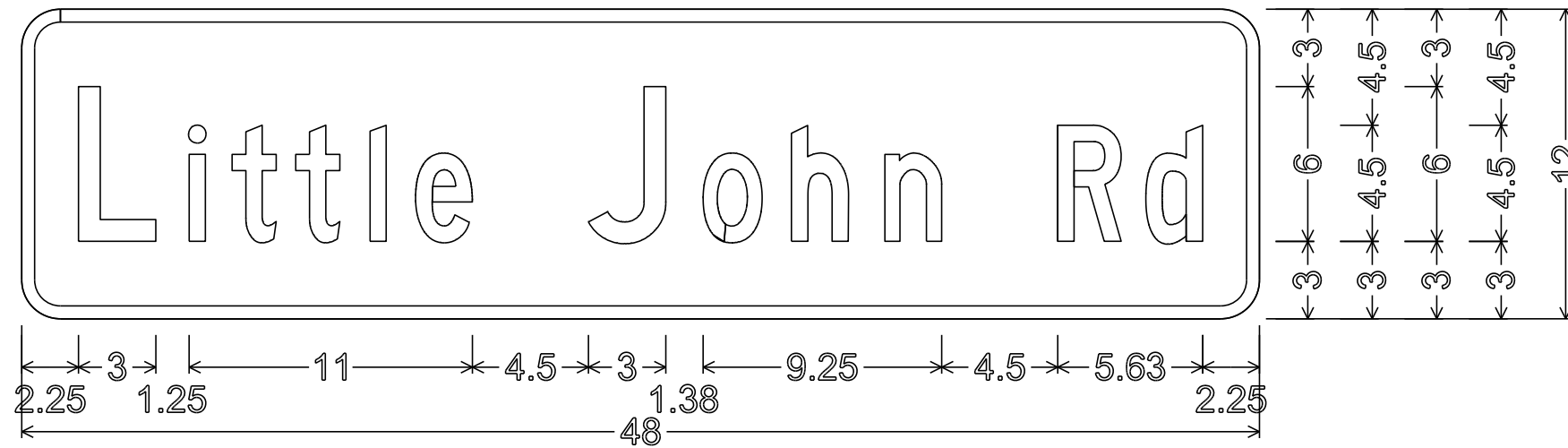

1.50" RADIUS, 0.50" BORDER, 0.00" INDENT
 COLORS: LEGEND - WHITE
 BACKGROUND - GREEN
 TEXT STYLE: C

D3-1

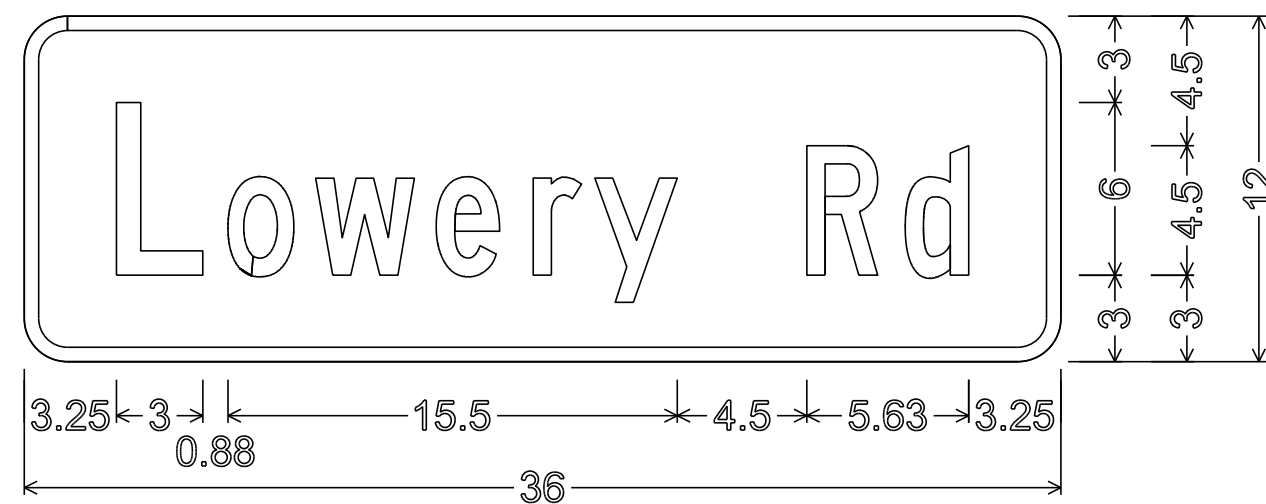

1.50" RADIUS, 0.50" BORDER, 0.00" INDENT
 COLORS: LEGEND - WHITE
 BACKGROUND - GREEN
 TEXT STYLE: C

D3-1

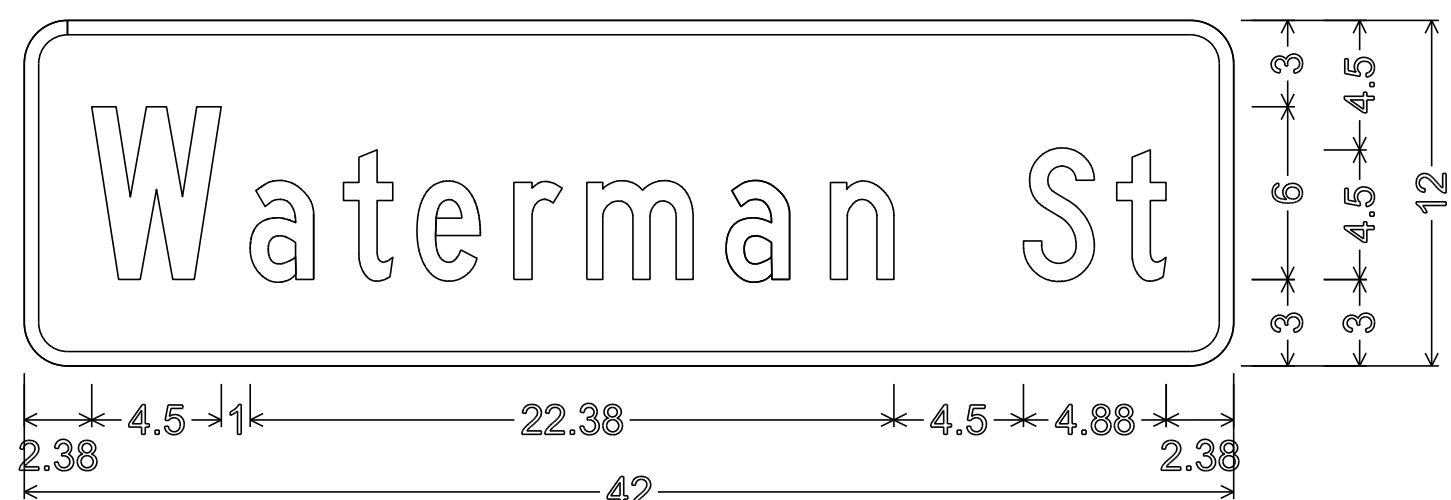

1.50" RADIUS, 0.50" BORDER, 0.00" INDENT
 COLORS: LEGEND - WHITE
 BACKGROUND - GREEN
 TEXT STYLE: C

D3-1

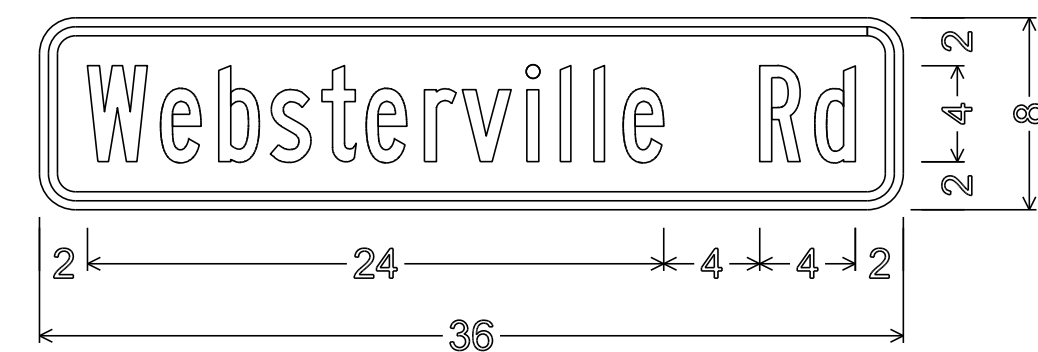

1.5" RADIUS, 0.375" BORDER, 0.375" INDENT
 COLORS: LEGEND - BLACK
 BACKGROUND - YELLOW
 TEXT STYLE: B

W16-8P

BARRE TOWN 1

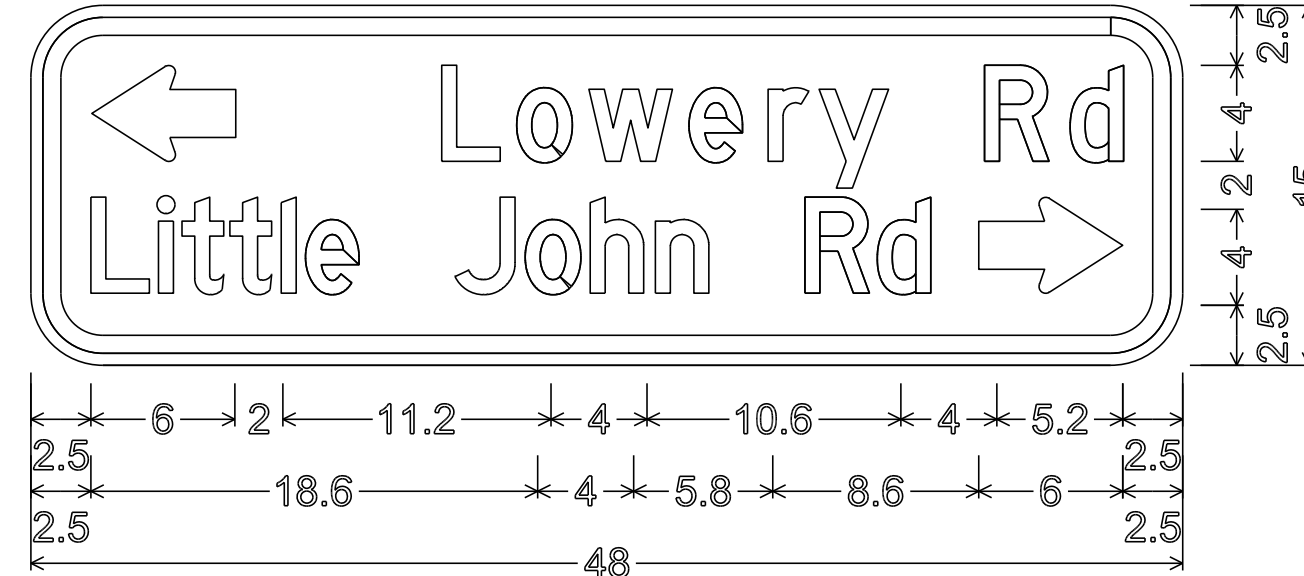

3.0" RADIUS, 0.75" BORDER, 0.50" INDENT
 COLORS: LEGEND - BLACK
 BACKGROUND - YELLOW
 TEXT STYLE: D

W16-8aP

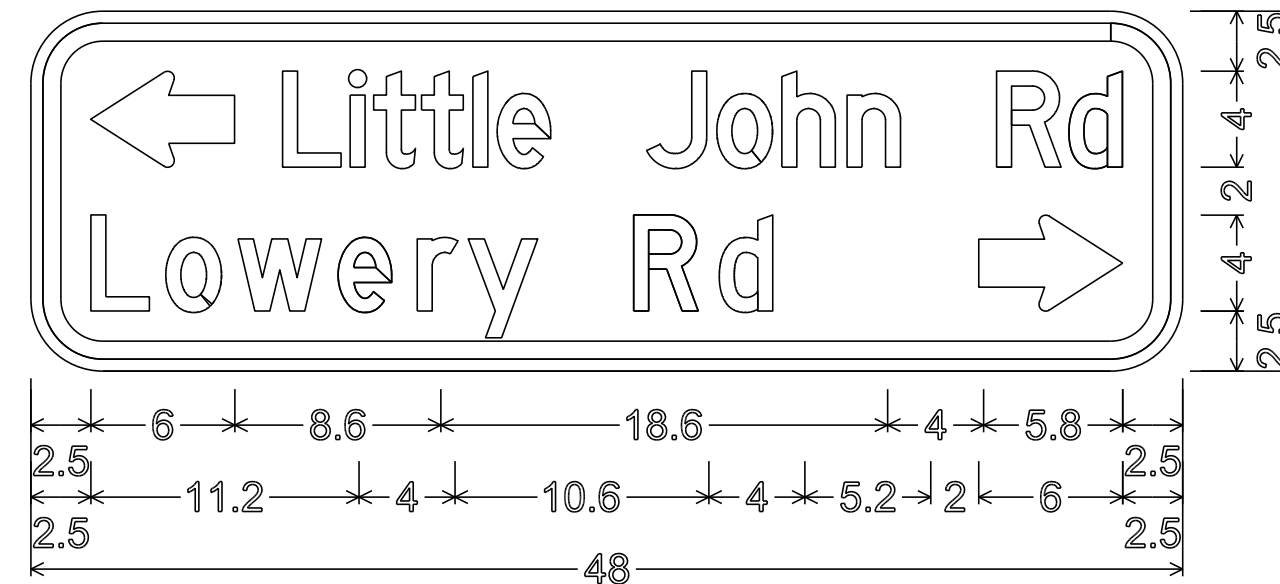

3.0" RADIUS, 0.75" BORDER, 0.50" INDENT
 COLORS: LEGEND - BLACK
 BACKGROUND - YELLOW
 TEXT STYLE: D

W16-8aP

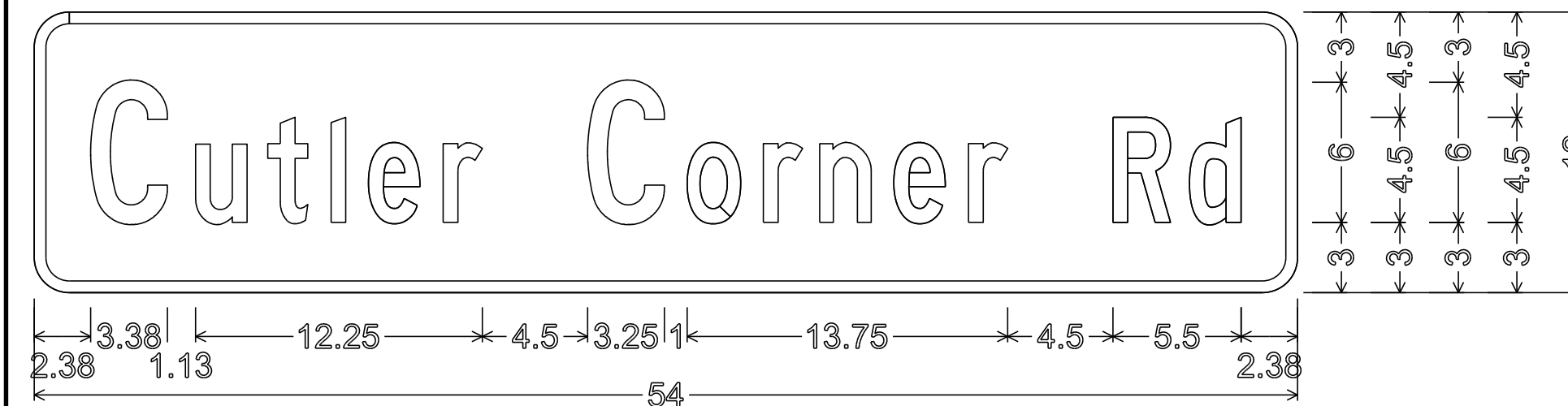

1.50" RADIUS, 0.50" BORDER, 0.00" INDENT
 COLORS: LEGEND - WHITE
 BACKGROUND - GREEN
 TEXT STYLE: C

D3-1



1.50" RADIUS, 0.50" BORDER, 0.00" INDENT
 COLORS: LEGEND - WHITE
 BACKGROUND - GREEN
 TEXT STYLE: C

D3-1



1.50" RADIUS, 0.50" BORDER, 0.00" INDENT
 COLORS: LEGEND - WHITE
 BACKGROUND - GREEN
 TEXT STYLE: C

D3-1

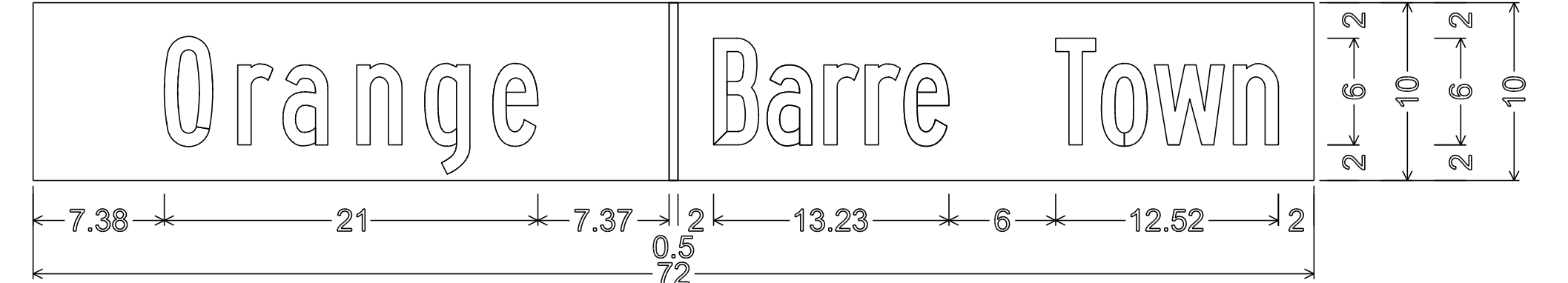

NO BORDER
 COLORS: LEGEND - WHITE
 BACKGROUND - GREEN
 TEXT STYLE: B

VD-024

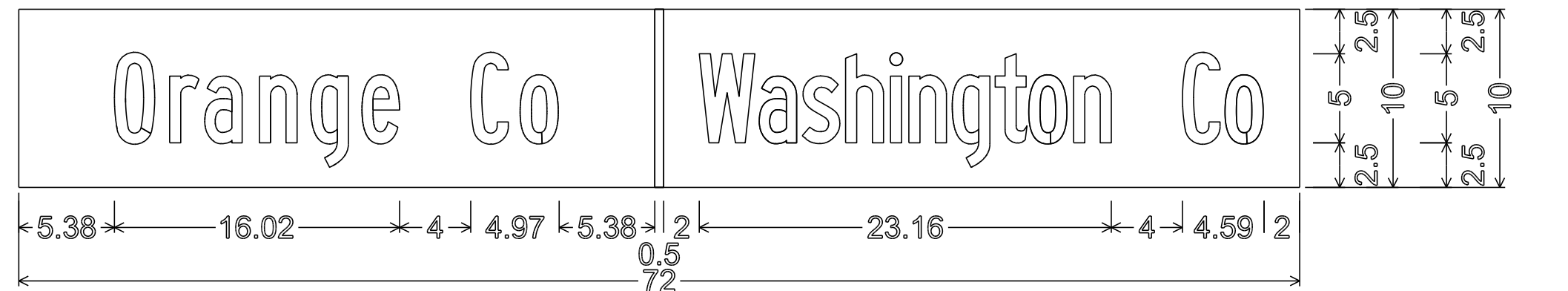

NO BORDER
 COLORS: LEGEND - WHITE
 BACKGROUND - GREEN
 TEXT STYLE: B

VD-025

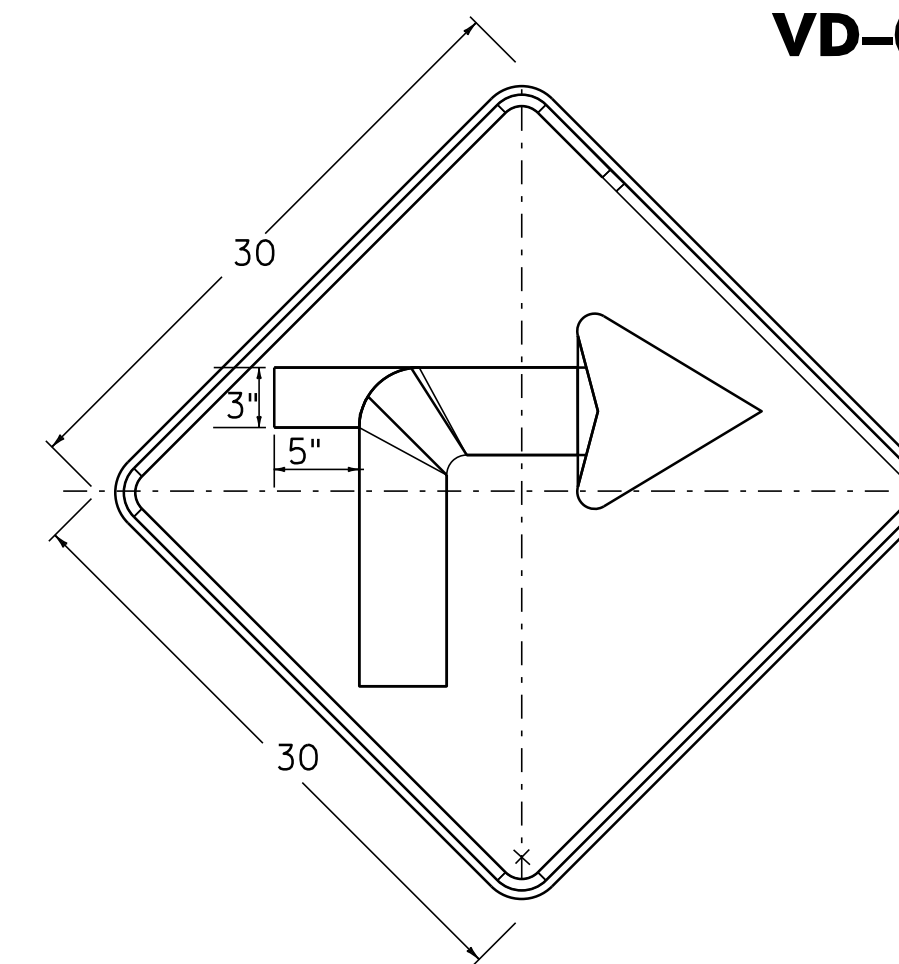

W1-1Ma R(L)

DIMENSIONS NOT SHOWN
 FOR THIS DETAIL SHALL CONFORM
 TO THE LATEST EDITION OF THE 2009 MUTCD
 FOR SIGN DETAIL W1-1.
 UNLESS OTHERWISE NOTED FOR THIS DETAIL

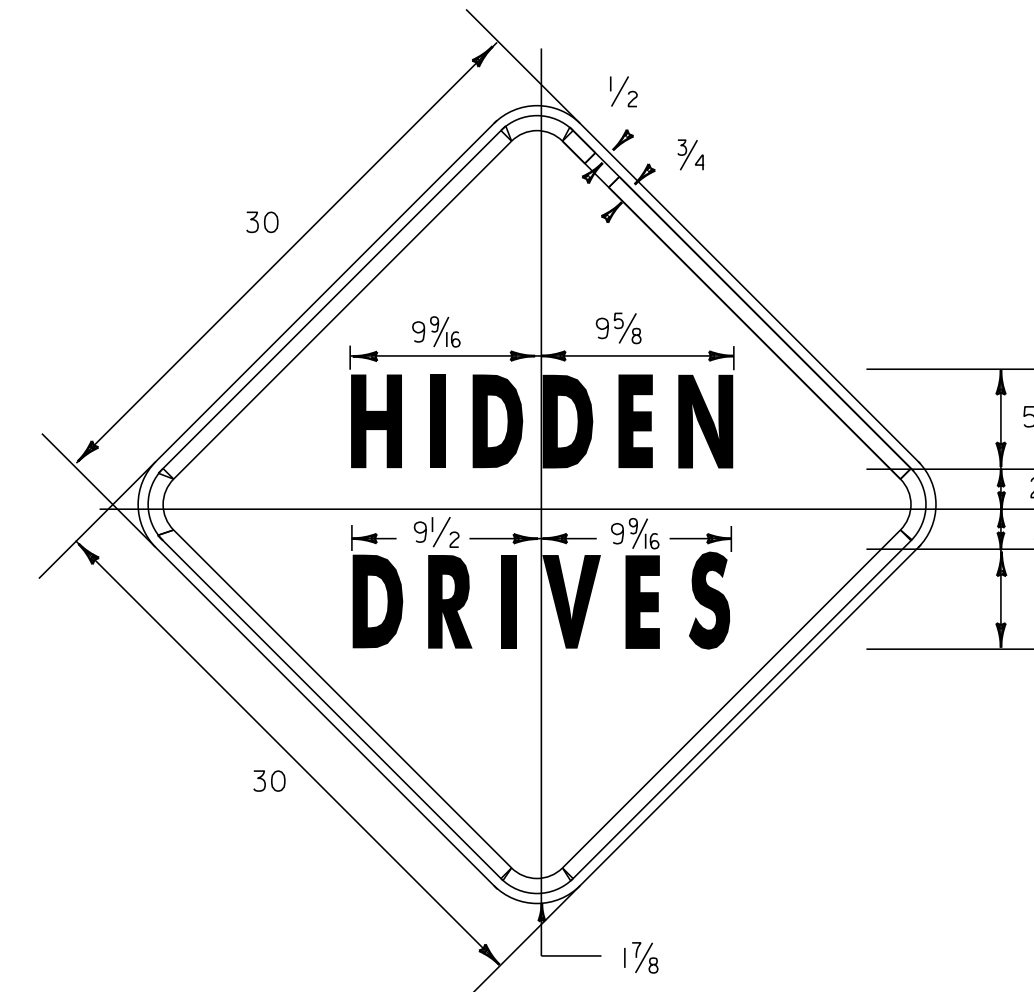

VW-060

1.1875" RADIUS, 0.75" BORDER, 0.50" INDENT
 COLORS: LEGEND - BLACK
 BACKGROUND - YELLOW
 TEXT STYLE: C

BARRE TOWN 2

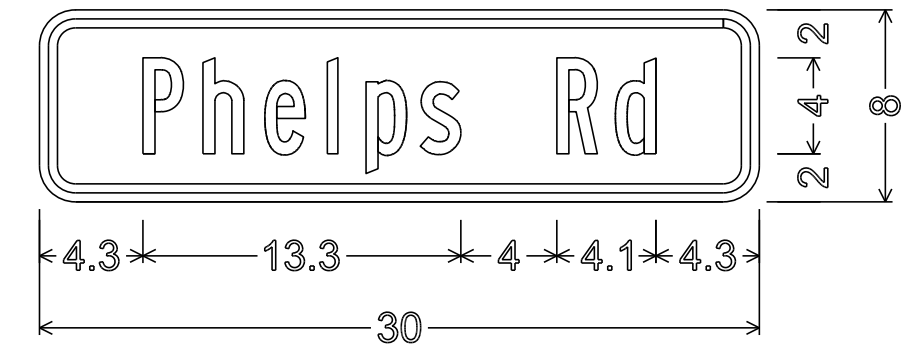

1.5" RADIUS, 0.375" BORDER, 0.375" INDENT
 COLORS: LEGEND - BLACK
 BACKGROUND - YELLOW
 TEXT STYLE: B

W16-8P

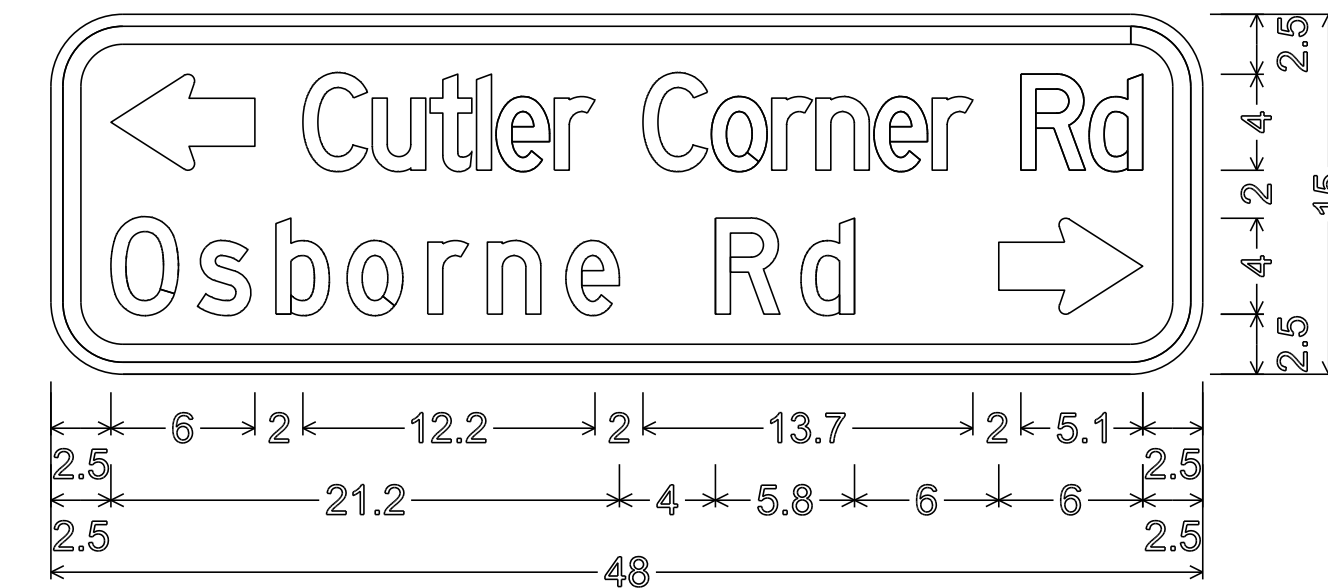

3.0" RADIUS, 0.75" BORDER, 0.50" INDENT
 COLORS: LEGEND - BLACK
 BACKGROUND - YELLOW
 TEXT STYLE: D

W16-8aP

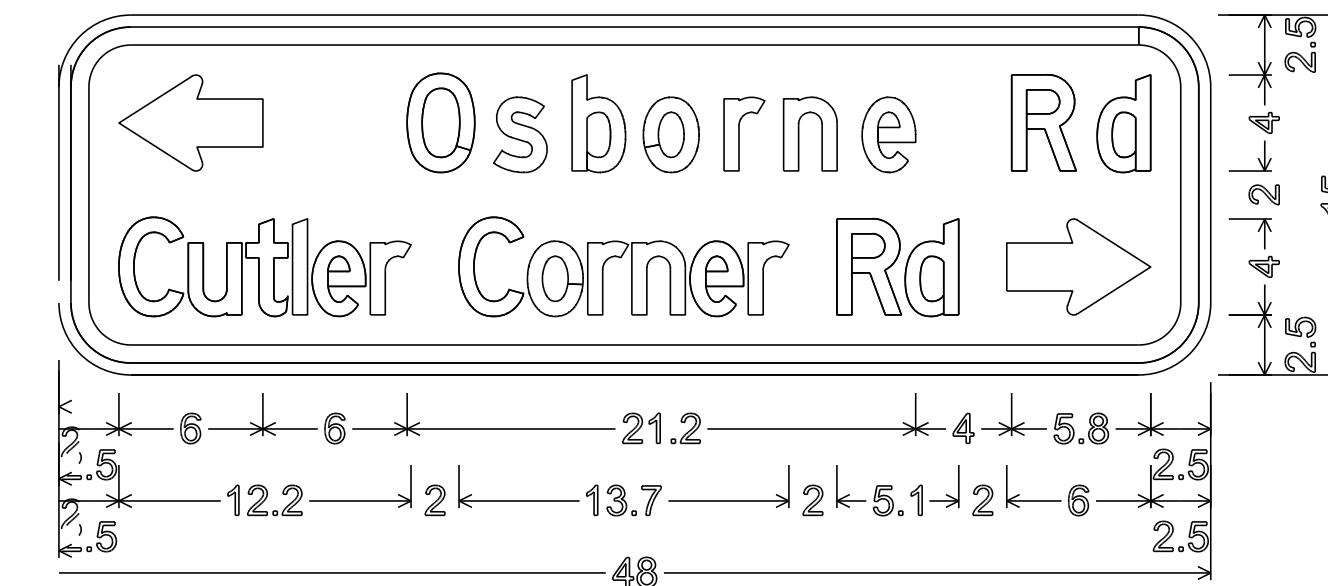

3.0" RADIUS, 0.75" BORDER, 0.50" INDENT
 COLORS: LEGEND - BLACK
 BACKGROUND - YELLOW
 TEXT STYLE: D

W16-8aP

ALL DIMENSIONS SHOWN IN INCHES UNLESS OTHERWISE NOTED.

PROJECT NAME: STATEWIDE NORTHEAST REGION
 PROJECT NUMBER: STP HRRR(4)

FILE NAME: I0K016_wrk.dgn
 PROJECT LEADER: JLS
 DESIGNED BY: NLA
 SPECIFIC SIGN DETAILS BARRE TOWN 1 & 2

PLOT DATE: 13-SEP-2012 15:46
 DRAWN BY: NLA
 CHECKED BY: JLS
 SHEET 8 OF 64