

W1-3R

SIGN	DIMENSIONS (INCHES)												
	A	B	C	D	E	F	G	H	J	K	L	M	
STD. & MIN.	36	3/8	7/8	17/16	4 1/2	5 1/4	1 1/4	3 3/8	4 1/2	12 3/8	1 7/8	2 1/4	
SPECIAL	48	3/4	1 1/4	23 3/8	5 5/8	7	1 5/8	4 7/8	6	16 3/8	2 3/8	3	

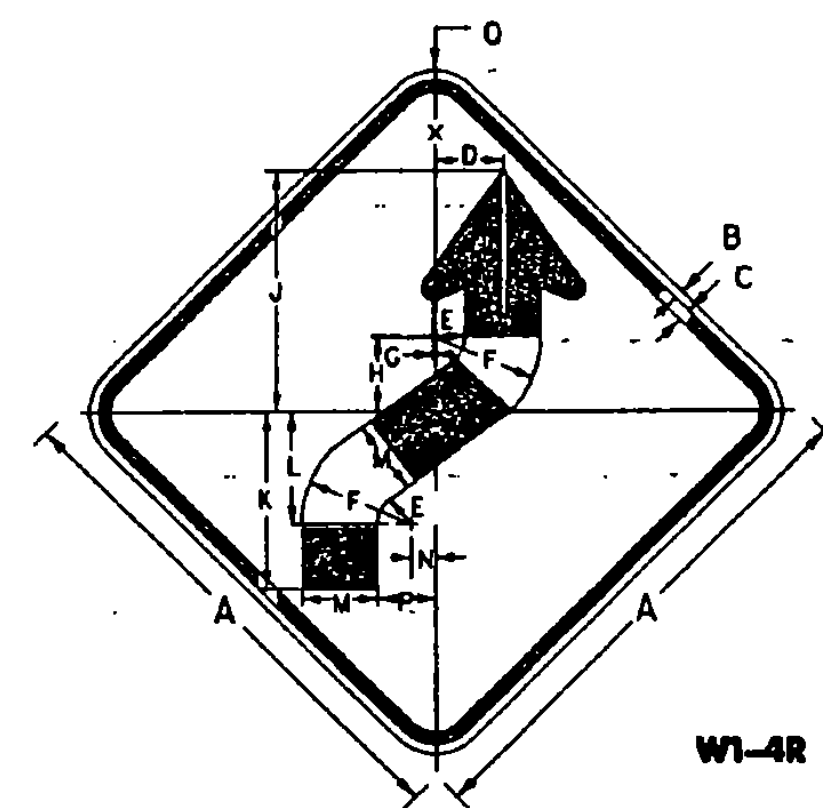

W1-4R

SIGN	DIMENSIONS (INCHES)														
	A	B	C	D	E	F	G	H	J	K	L	M	N	P	Q
STD. & MIN.	36	3/8	7/8	4 1/2	2 1/4	7 1/2	3/2	5 1/4	16 3/8	12 3/8	7 7/8	5 1/4	1 1/8	3 3/8	2 1/4
SPECIAL	48	3/4	1 1/4	6 5/8	3	10	3/2	7	22 1/2	16 1/2	10 1/2	7	2 1/4	5 1/4	3

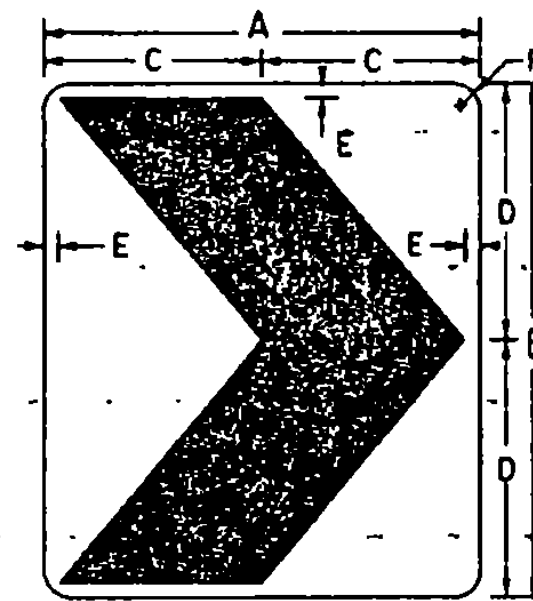

W1-8

SIGN	DIMENSIONS (INCHES)					
	A	B	C	D	E	F
STD.	18	24	9	12	3/4	1 1/2
SPECIAL	24	30	12	15	1 1/2	2 1/4
EXPWY.	30	36	15	18	1 1/2	2 1/4
FRWY.	36	48	18	24	1 1/2	2 1/4

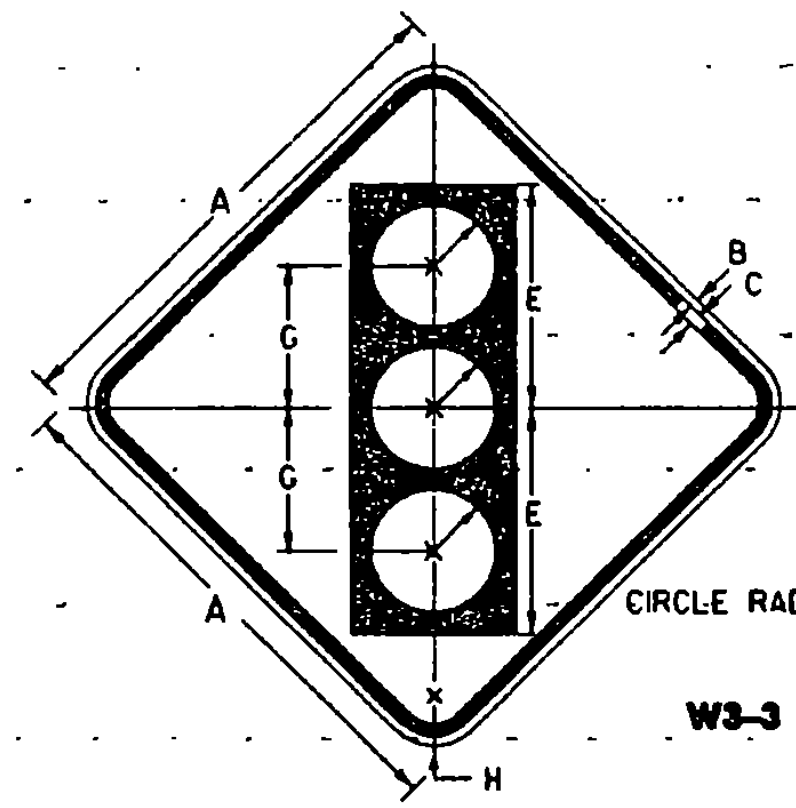

W3-3

SIGN	DIMENSIONS (INCHES)							
	A	B	C	D	E	F	G	H
STD. & MIN.	36	3/8	7/8	5 3/4	15 3/4	4 1/4	10	2 1/4
SPECIAL	48	3/4	1 1/4	7 1/2	20	5	12 1/2	3

**COLORS**

SYMBOL & LEGEND - BLACK (NON-REFL)  
BACKGROUND - ORANGE (REFL)  
TOP CIRCLE - RED (REFL)  
MIDDLE CIRCLE - YELLOW (REFL)  
BOTTOM CIRCLE - GREEN (REFL)

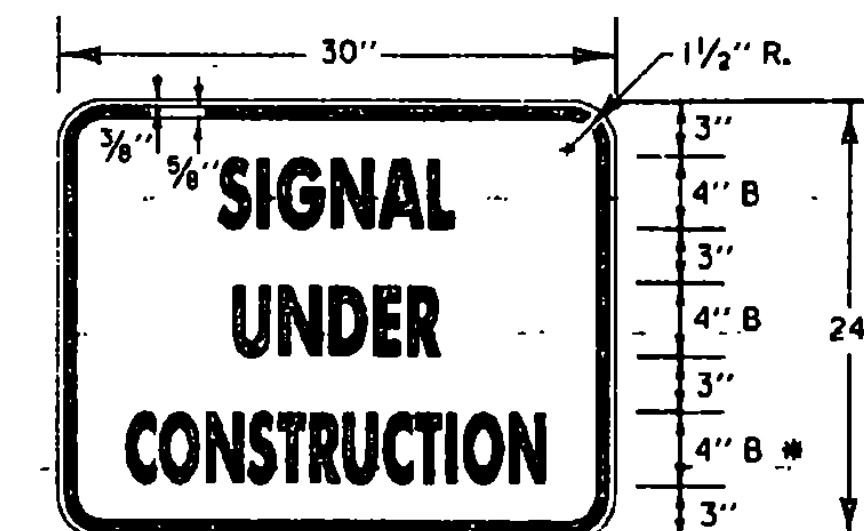

\* REDUCE SPACING 50%

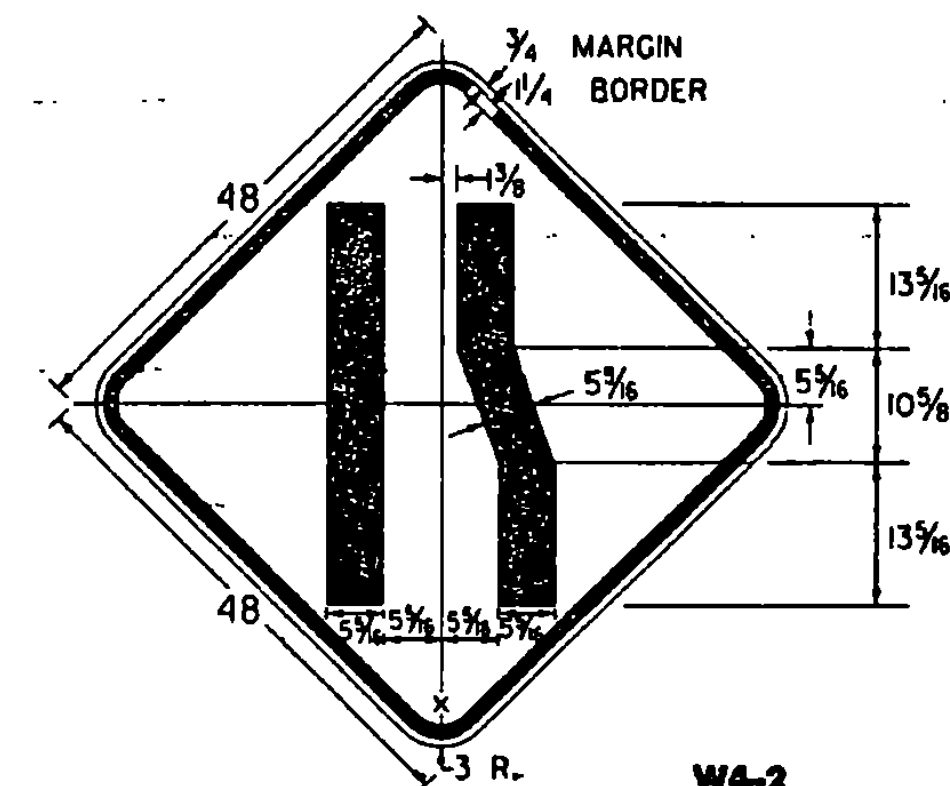

W4-2

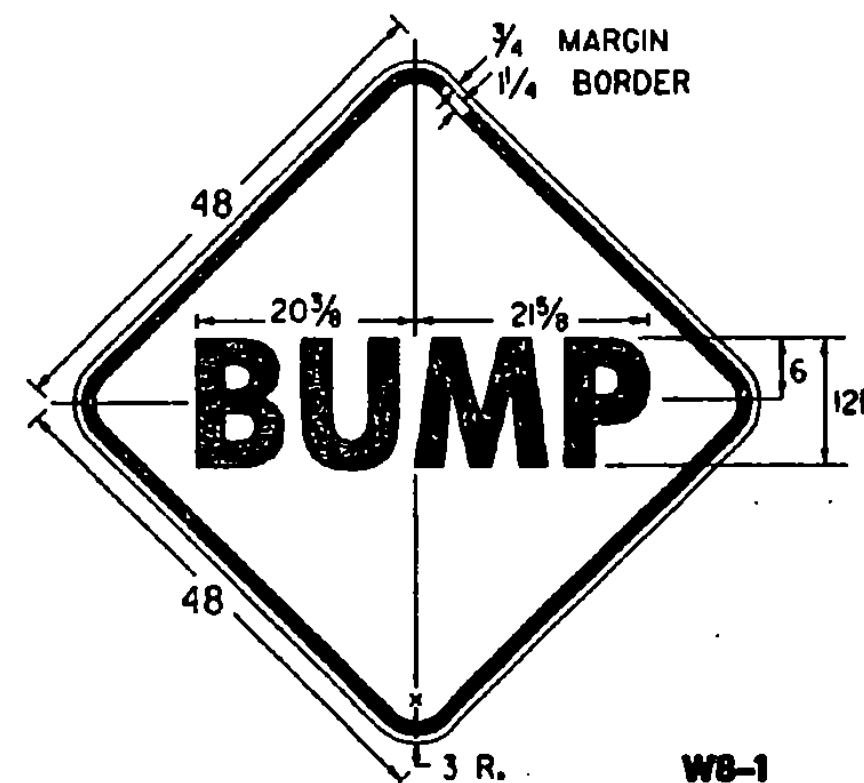

W8-1

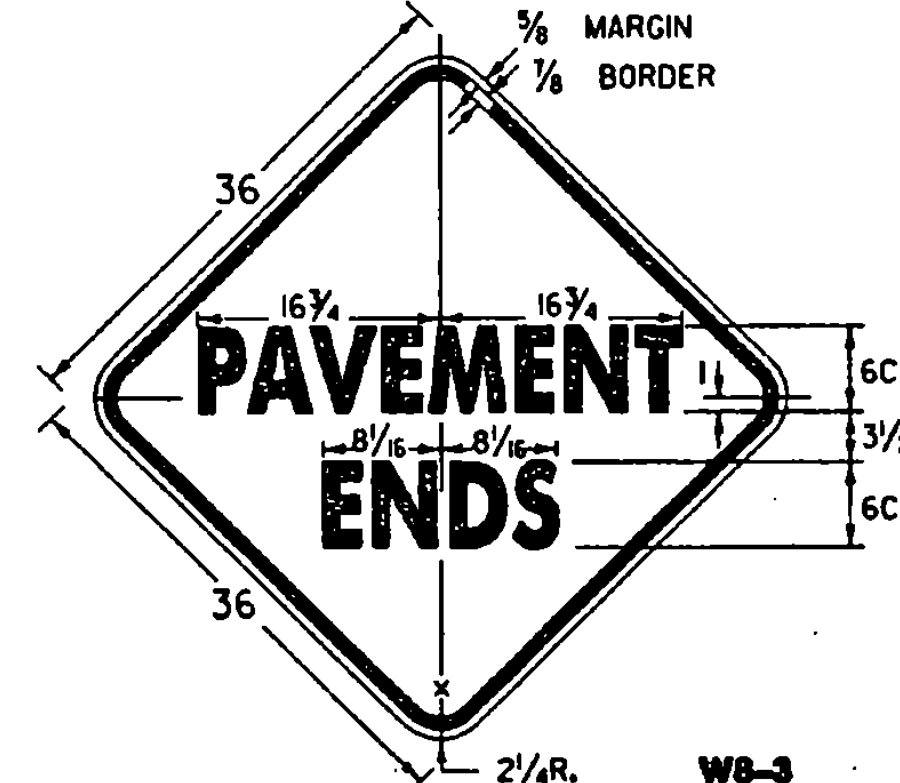

W8-3

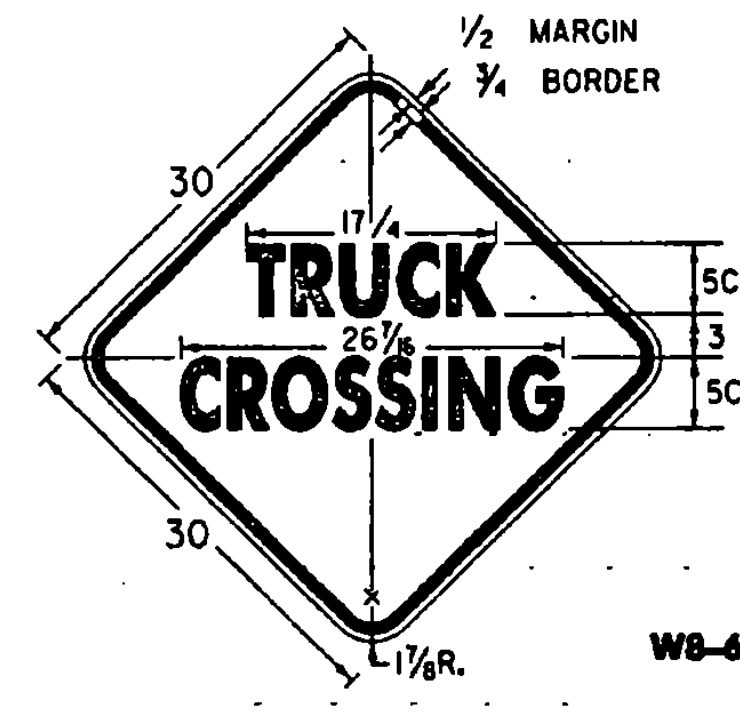

W8-4

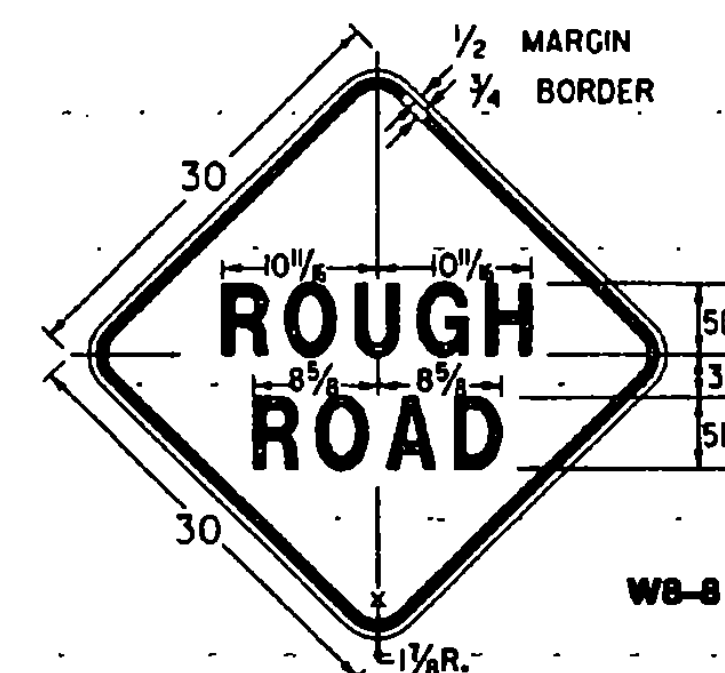

W8-8

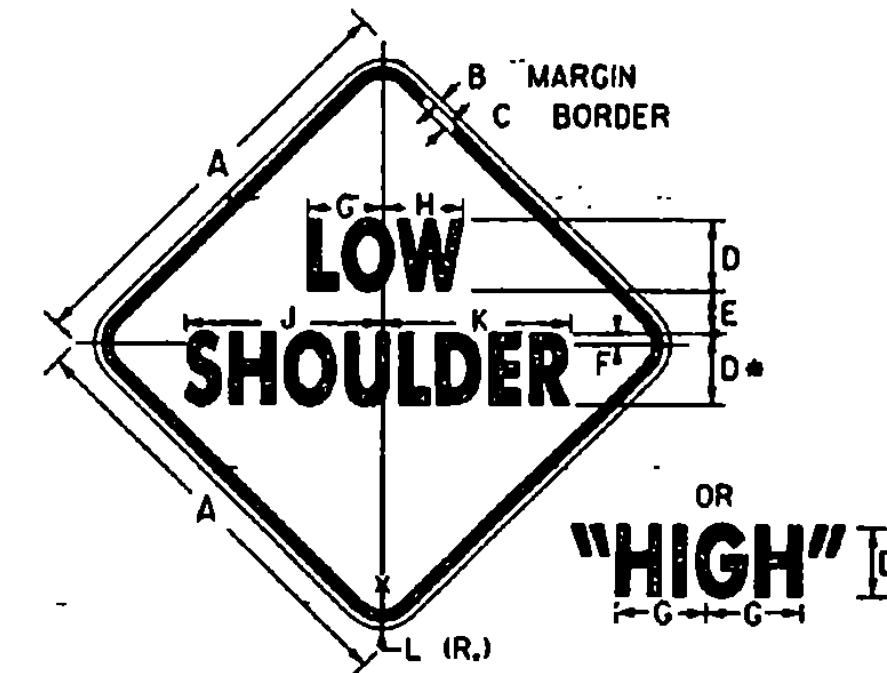

W8-9

SIGN	DIMENSIONS (INCHES)										
	A	B	C	D	E	F	G	H	J	K	L
STD.	30	1/2	3/4	5C	3	3 1/2	5 3/8	5 3/8	13 3/8	13 3/8	1 1/8
FRWY.	48	3/4	1 1/4	8C	5	5 1/2	8 3/4	8 3/4	21 3/8	20 3/8	3

**NOTES**

SEE STANDARD SHEET E-100 FOR NOTES AND TEXT DETAILS  
COLORS FOR SIGNS SHOWN ON THIS SHEET SHALL BE BLACK TEXT, BORDER AND SYMBOLS ON A REFLECTORIZED TYPE II B OR TYPE III ORANGE BACKGROUND, UNLESS OTHERWISE NOTED.  
SIGNS USED ONLY FOR DAYTIME MAINTENANCE OPERATIONS DO NOT NEED TO BE REFLECTORIZED, HOWEVER, THESE SIGNS SHALL BE LABELED "DAYTIME USE ONLY" ON THE BACK OF THE SIGN PANEL WITH 3" SERIES C LETTERS.

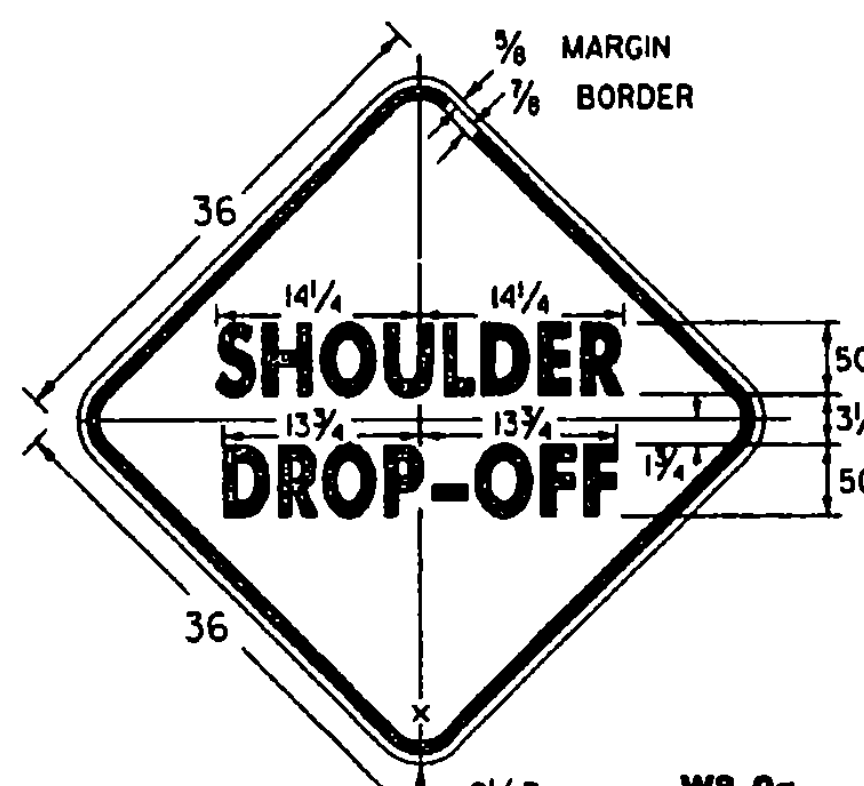

W8-9a

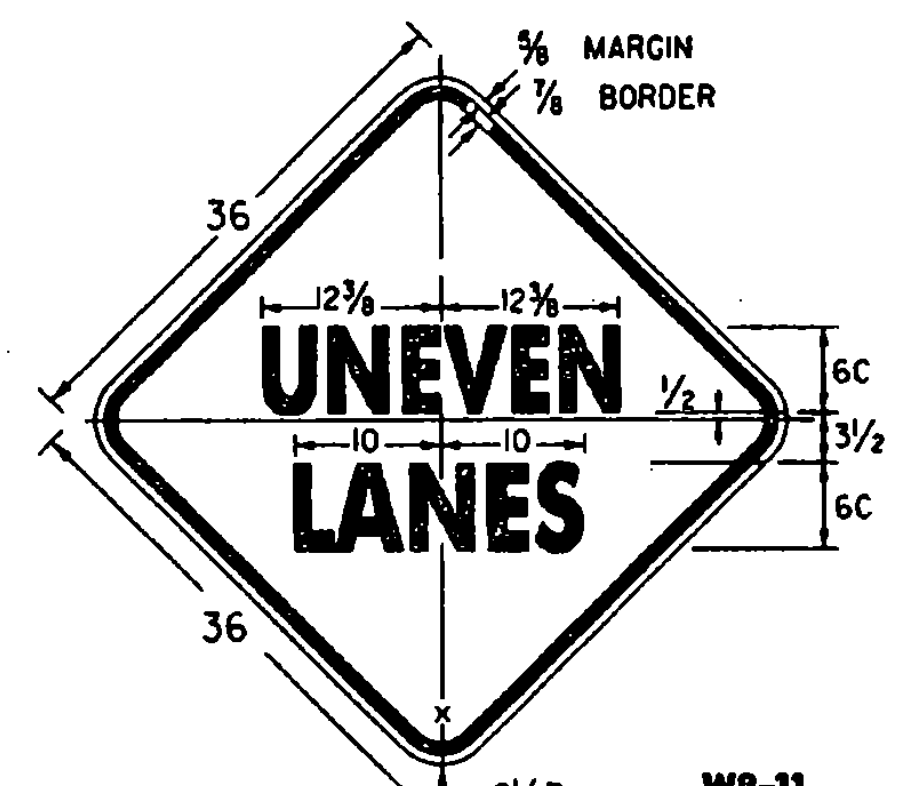

W8-11

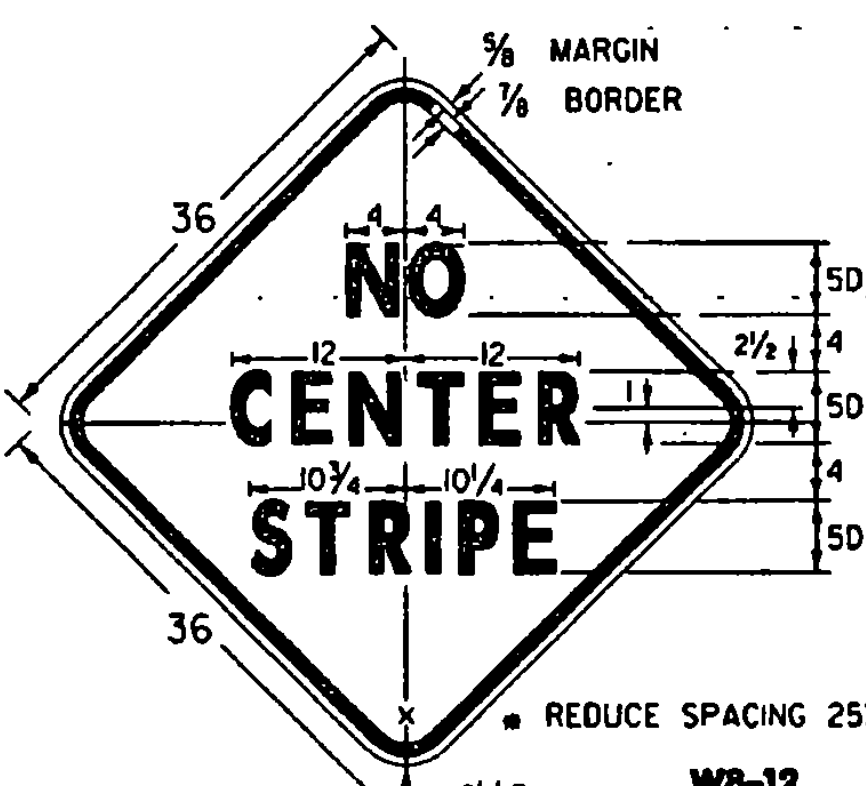

W8-12

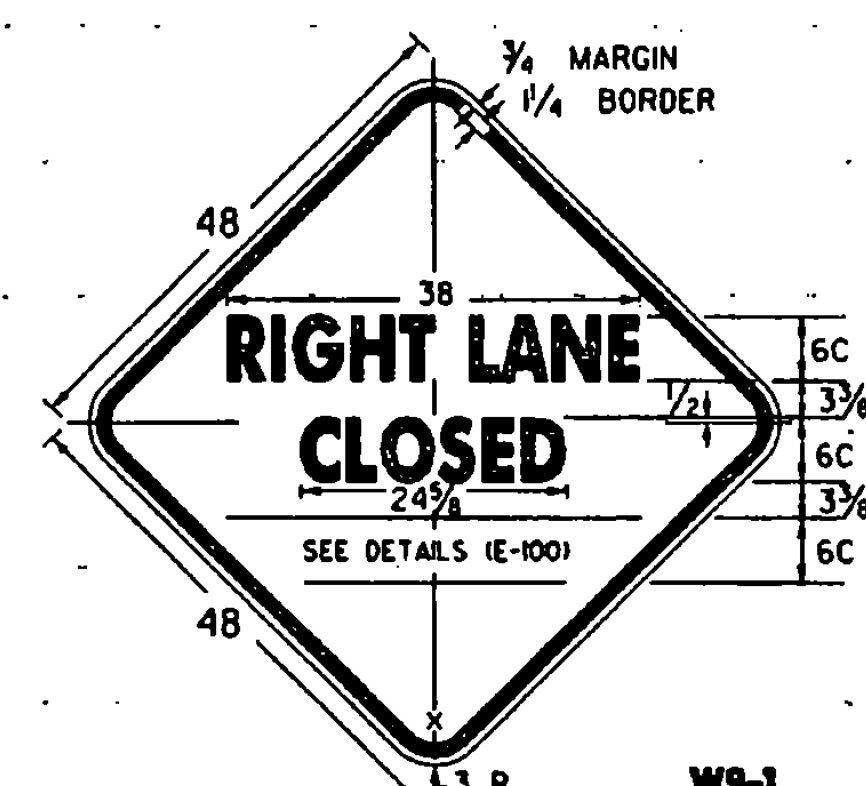

W9-1

(ALL DIMENSIONS SHOWN IN INCHES) LEFT LANE

OTHER STDS. E-100 REQUIRED:

**REVISIONS AND CORRECTIONS**  
OCT. 30, 1987 - DATE OF ORIGINAL ISSUE  
OCT. 21, 1992 - ADDED ADDITIONAL SIGN DIMENSIONS, REVISED CHEVRON BACKGROUND TO ORANGE, & REVISED TITLE BLOCK  
AUG. 08, 1995 - ADDED AND DELETED VARIOUS SIGN DETAILS

APPROVED  
*Stephen D. McArthur*  
DIRECTOR OF ENGINEERING  
*David A. Ross*  
TRAFFIC AND SAFETY ENGINEER

CONSTRUCTION SIGN DETAILS

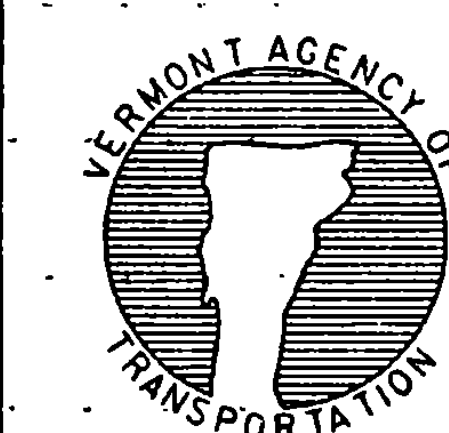

STANDARD E-101

APPROVED FOR THIS PROJECT AND/OR DESIGN IMPLEMENTATION. FHWA FINAL APPROVAL PENDING.

/traf/std/stdel01.dgn | stdel01.i