

'XX' DENOTES ADVISORY SPEED AS SHOWN ON THE PLANS

W13-1

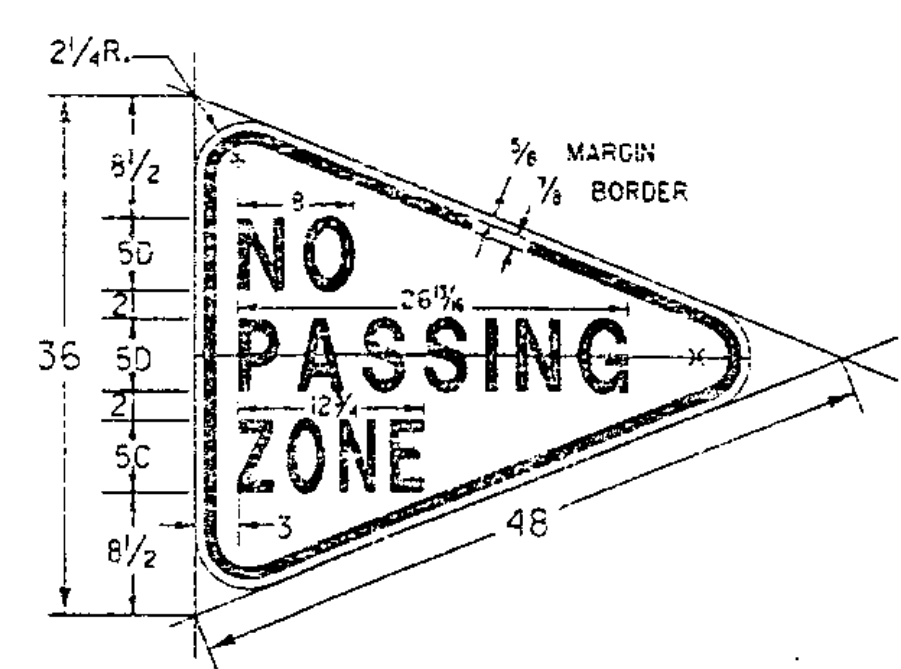

W14-3

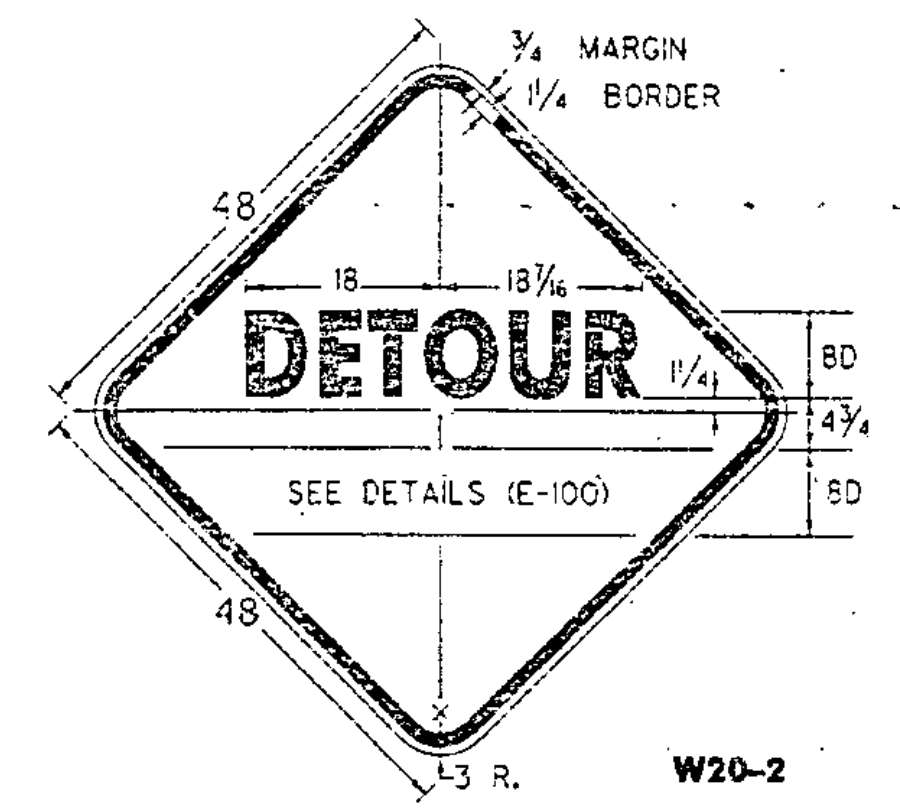

W20-2

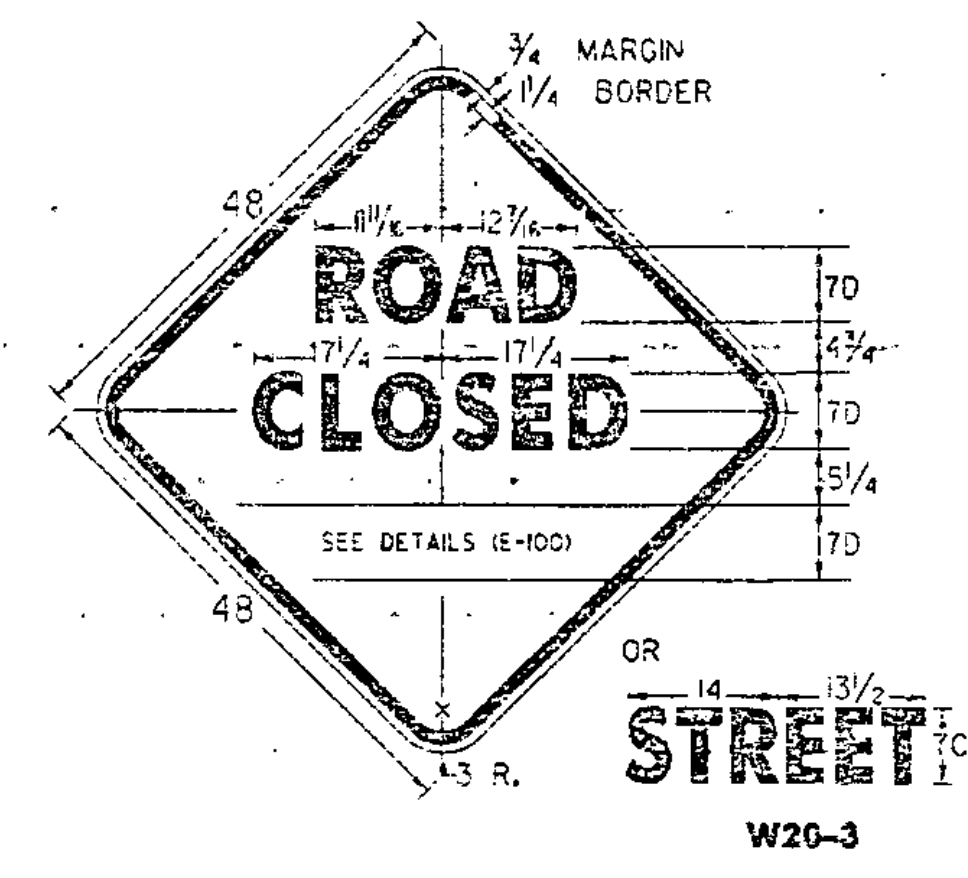

W20-3

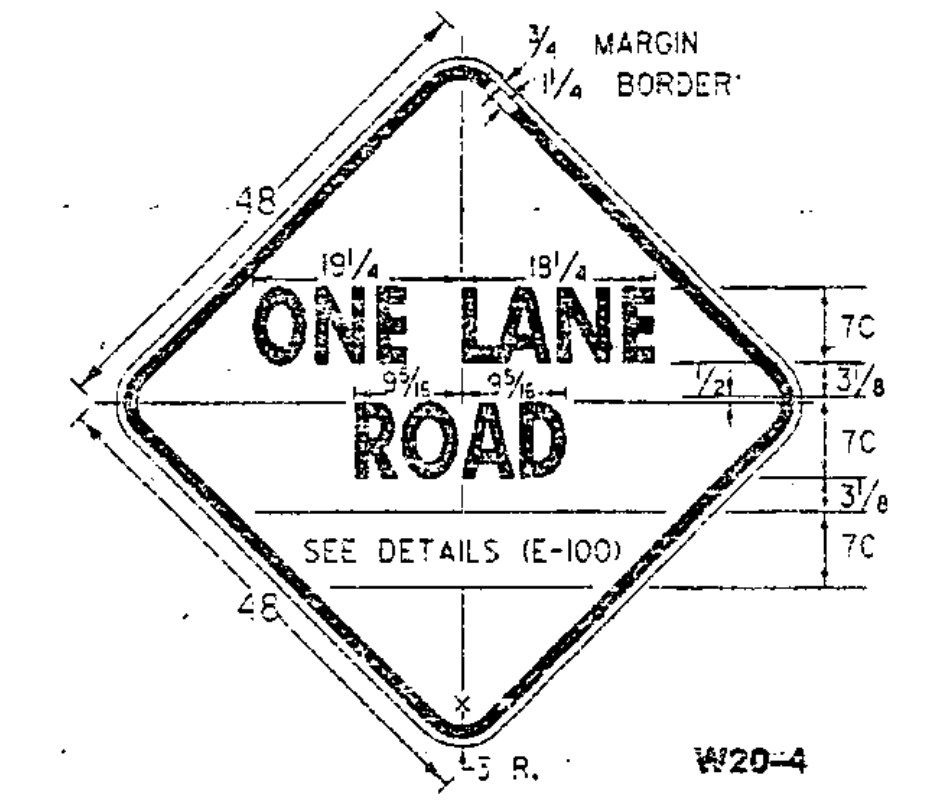

W20-4

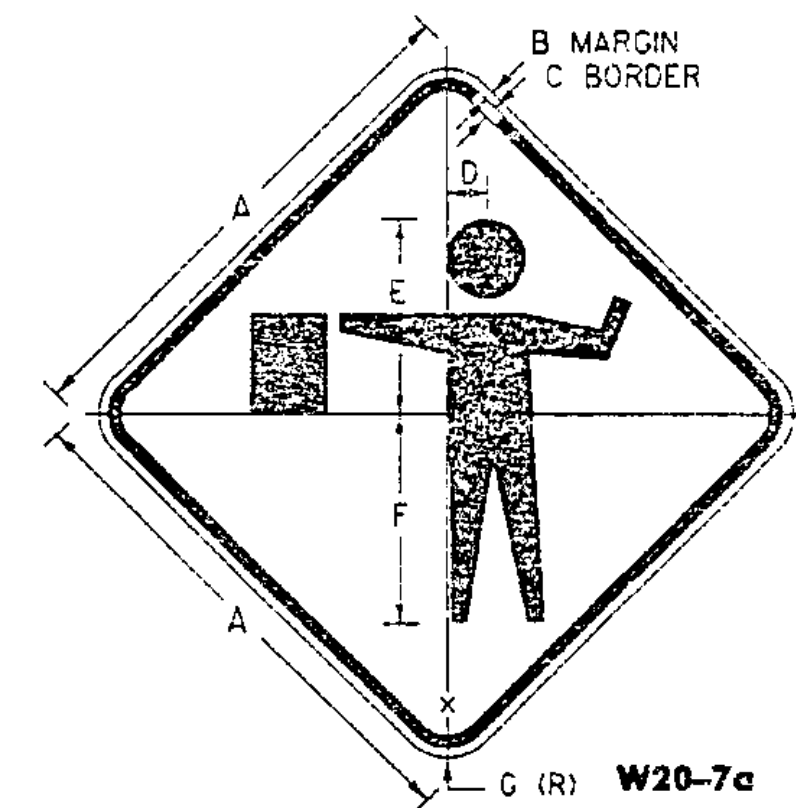

W20-7a

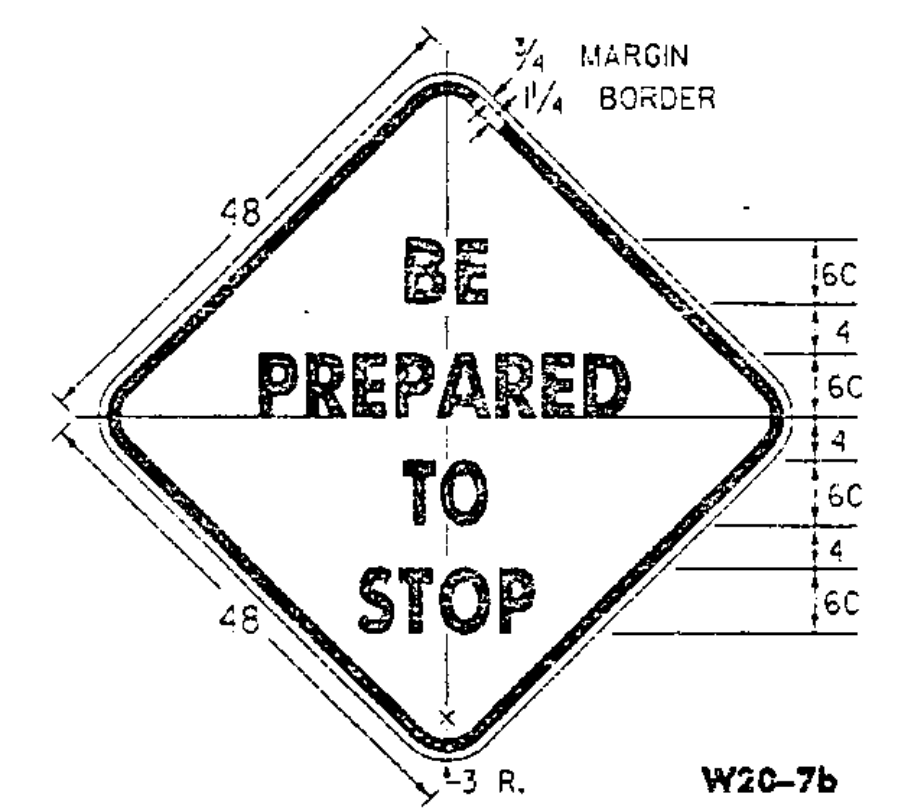

W20-7b

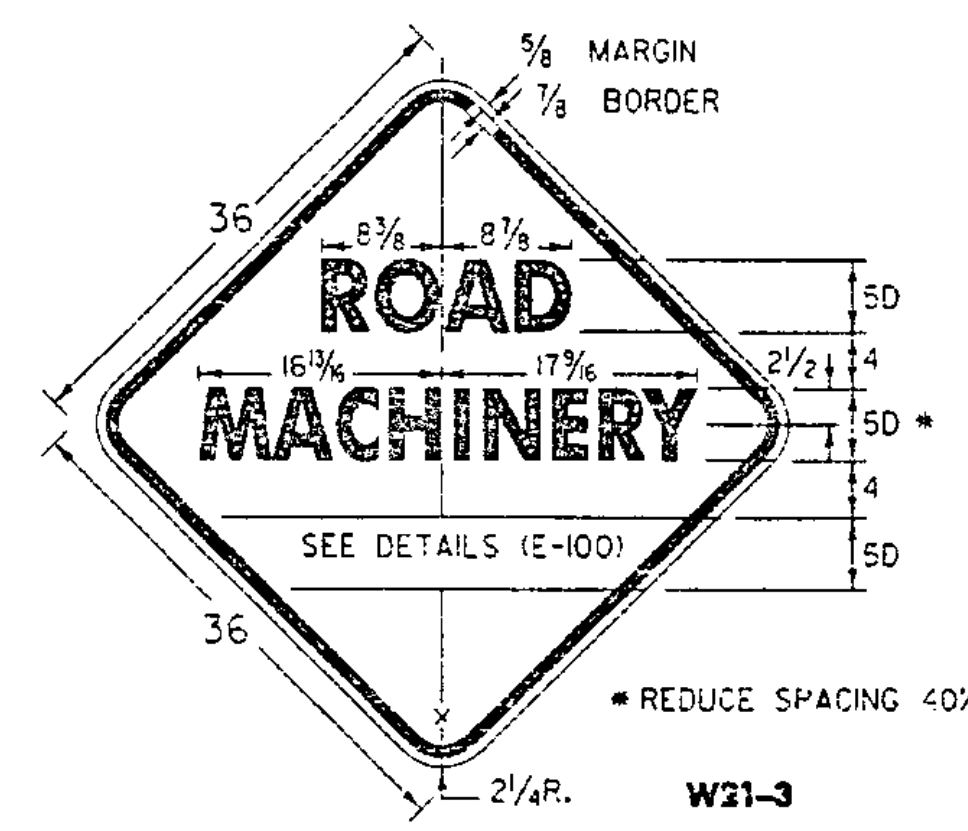

W21-3

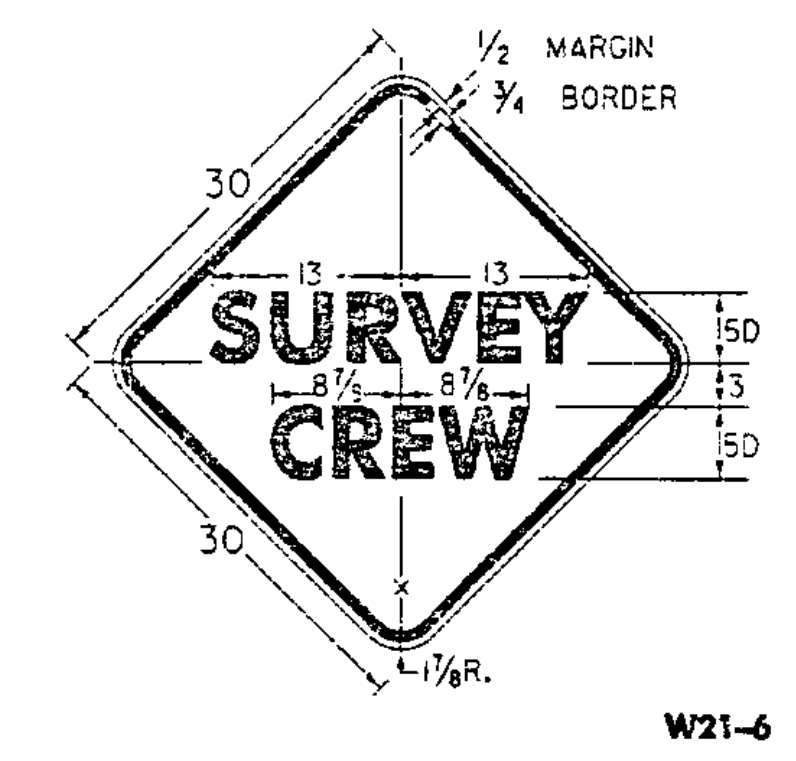

W21-6

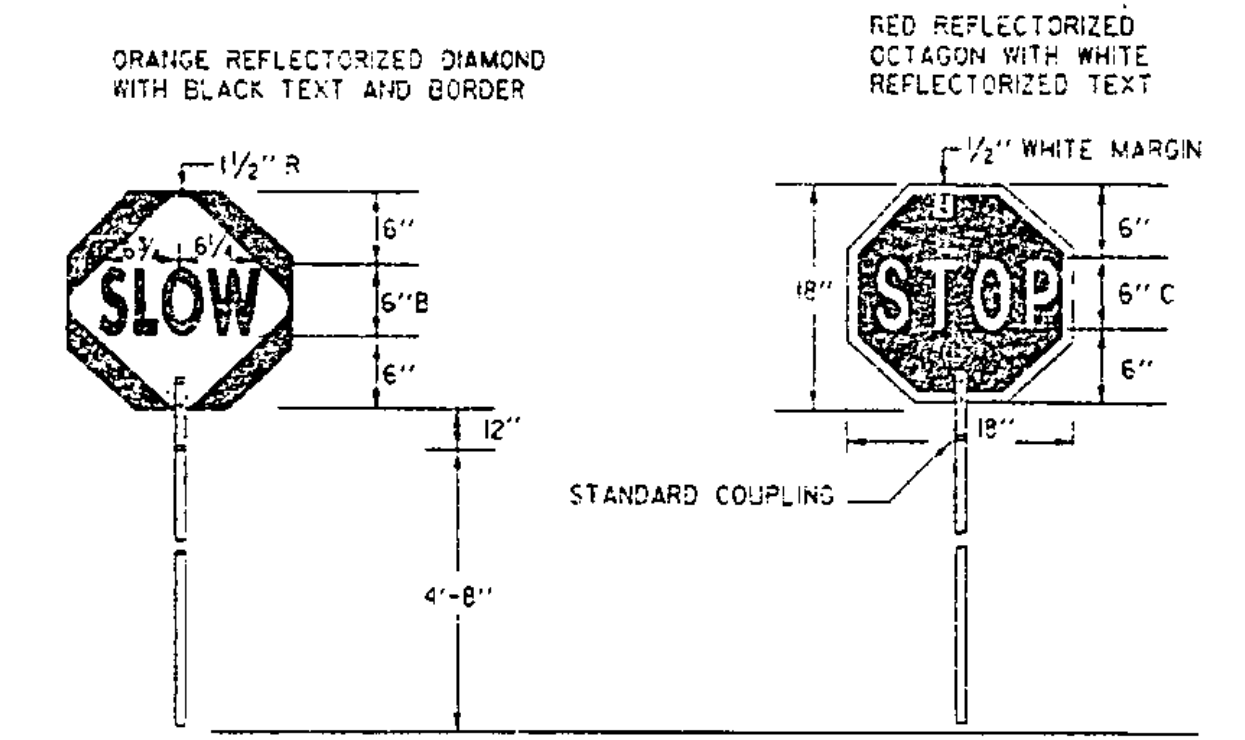

SIGN DETAIL

STAFF DETAIL

MATERIALS
THE SIGN MATERIALS SHALL BE 0.063" ALUMINUM WITH COLORS AS INDICATED ON DETAILS.
THE STAFF SHALL BE 3/4" TO 1" DIAMETER RIGID ALUMINUM CONDUIT/TUBING WITH A WALL THICKNESS OF 0.125" OR 1" TO 1 1/2" DIAMETER RIGID PVC CONDUIT/TUBING WITH 0.125" WALL THICKNESS.

MOUNTING
THE STAFF SHALL BE MOUNTED WITH EITHER TWO 1/4" DIAMETER ALUMINUM BOLTS OR TWO 1/2" DIAMETER ALUMINUM RIVETS.

SIGN PADDLE FOR FLAGPERSON

NOTES

SEE STANDARD SHEET E-100 FOR NOTES AND TEXT DETAILS
COLORS FOR SIGNS SHOWN ON THIS SHEET SHALL BE BLACK TEXT, BORDER AND SYMBOLS SHALL BE ON A REFLECTORIZED ORANGE BACKGROUND OF TYPE IIB OR TYPE III REFLECTIVE SHEETING, UNLESS OTHERWISE NOTED. THE EXCEPTION IS THE PADDLE SIGN.
SIGN DETAILS INDICATE THE APPROPRIATE COLOR.
SIGNS USED ONLY FOR DAYTIME MAINTENANCE OPERATIONS DO NOT NEED TO BE REFLECTORIZED, HOWEVER, THESE SIGNS SHALL BE LABELED "DAYTIME USE ONLY" ON THE BACK OF THE SIGN PANEL WITH 3" SERIES C LETTERS.

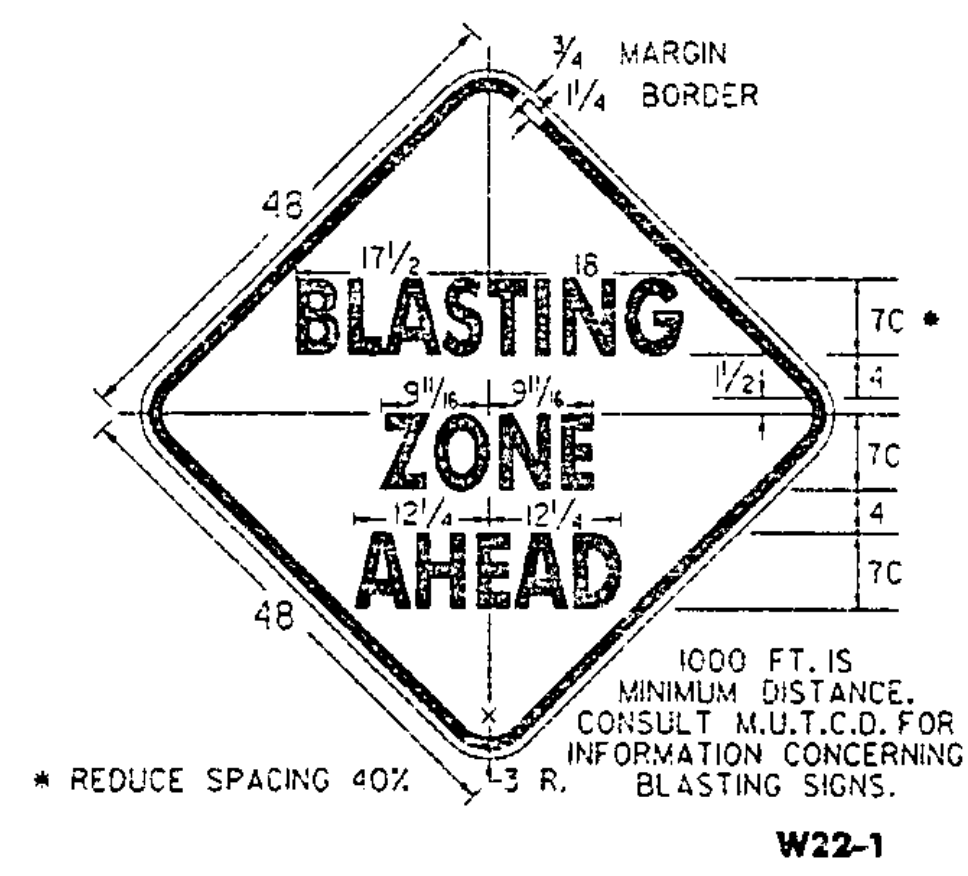
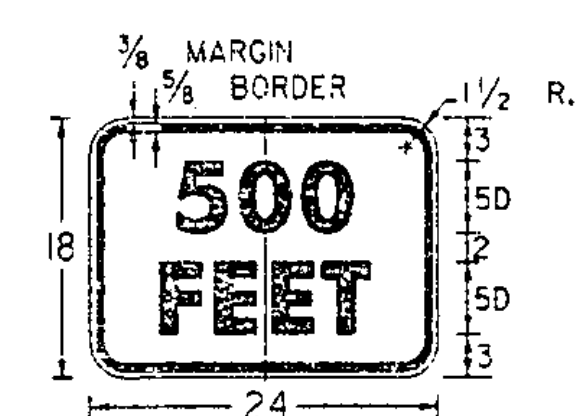
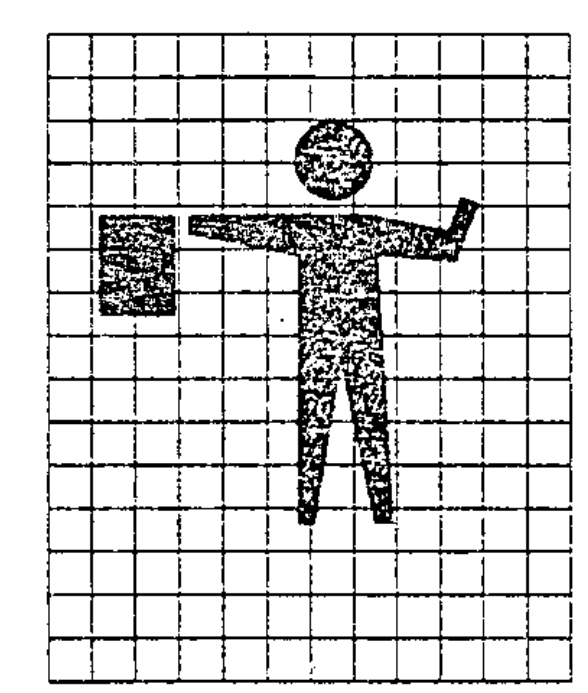

W22-1

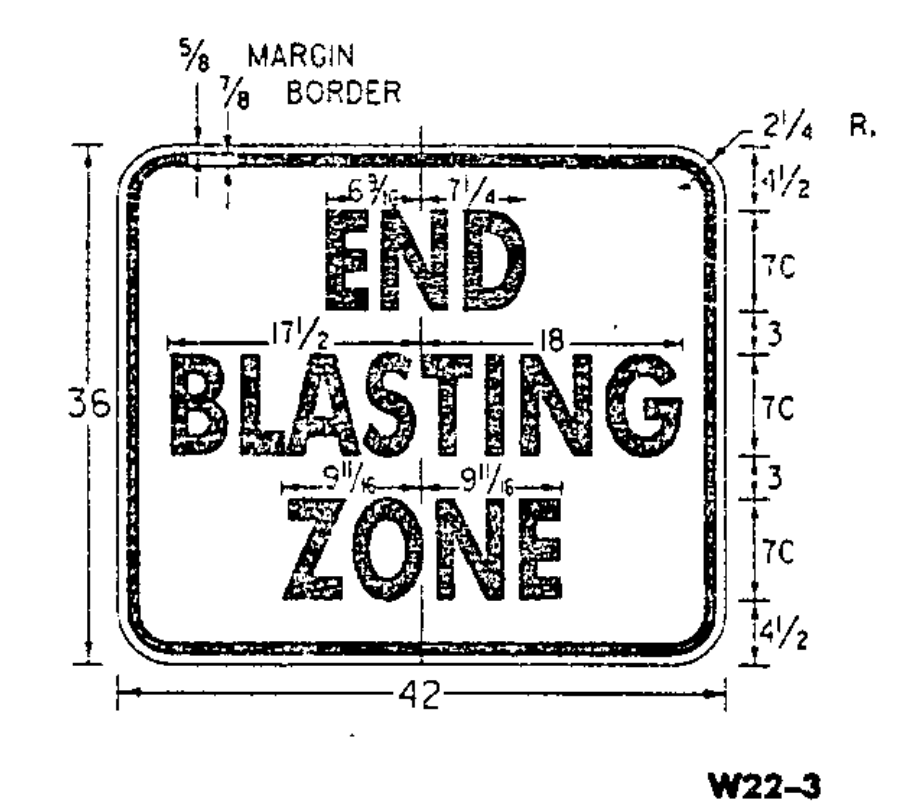

W22-3

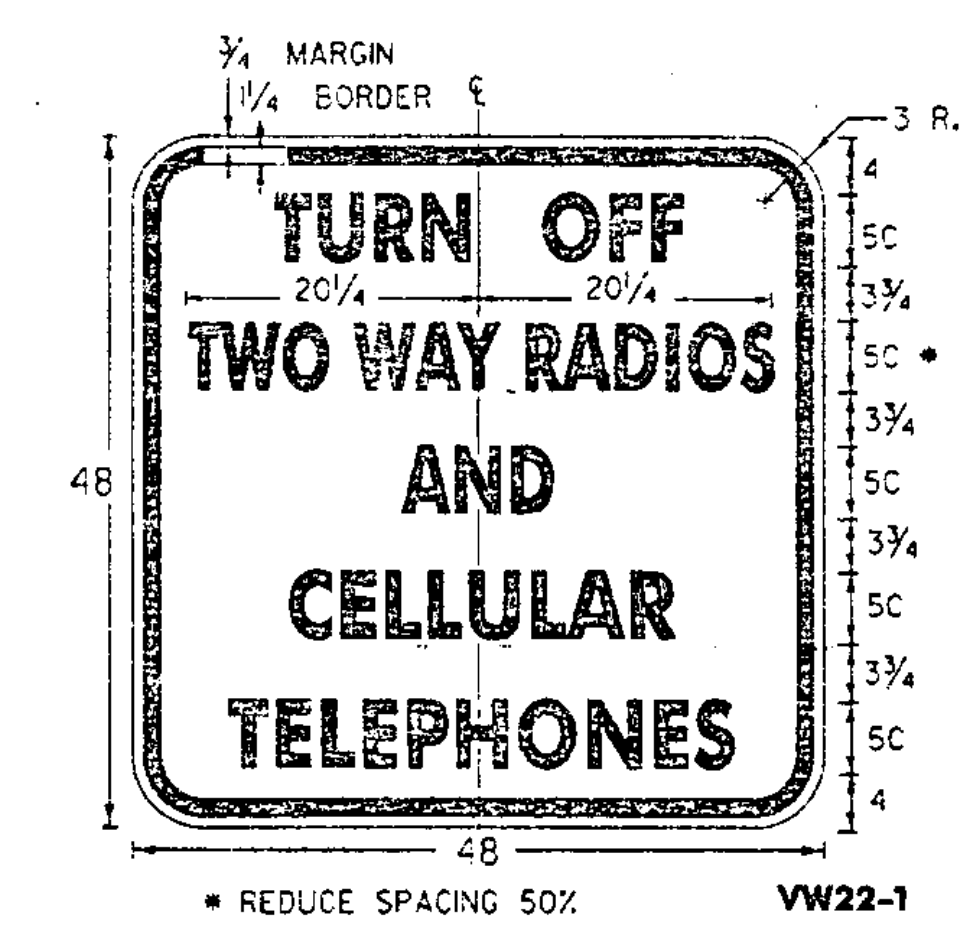

W22-1

SIGN	DIMENSIONS (INCHES)						
	A	B	C	D	E	F	G
STD.	36	1 3/4	7/8	2 3/4	13 1/2	14 3/4	2 1/4
FWY.	48	3/4	1 1/4	3 3/4	18	19 1/2	3

(ALL DIMENSIONS SHOWN IN INCHES)

OTHER STDS. E-100 REQUIRED:

REVISIONS AND CORRECTIONS
OCT. 30, 1987 - DATE OF ORIGINAL ISSUE
JAN. 23, 1989 - DELETE MOTORCYCLE SYMBOL SIGN AND SPEED SIGN, ADDED TWO SIGNS
OCT. 21, 1992 - ADDED A SIGN, REVISED A SIGN DIMENSION & TYPE ERROR & REVISED TITLE BLOCK
AUG. 08, 1995 - ADDED FLAGGER GRID

APPROVED
Stephen J. McArthur
DIRECTOR OF ENGINEERING
David A. Ross
TRAFFIC AND SAFETY ENGINEER

CONSTRUCTION SIGN
DETAILS



STANDARD
E-102

APPROVED FOR THIS PROJECT AND/OR DESIGN IMPLEMENTATION, FHWA FINAL APPROVAL PENDING.