

COLORS AND MATERIALS SHALL BE IN ACCORDANCE WITH E-151

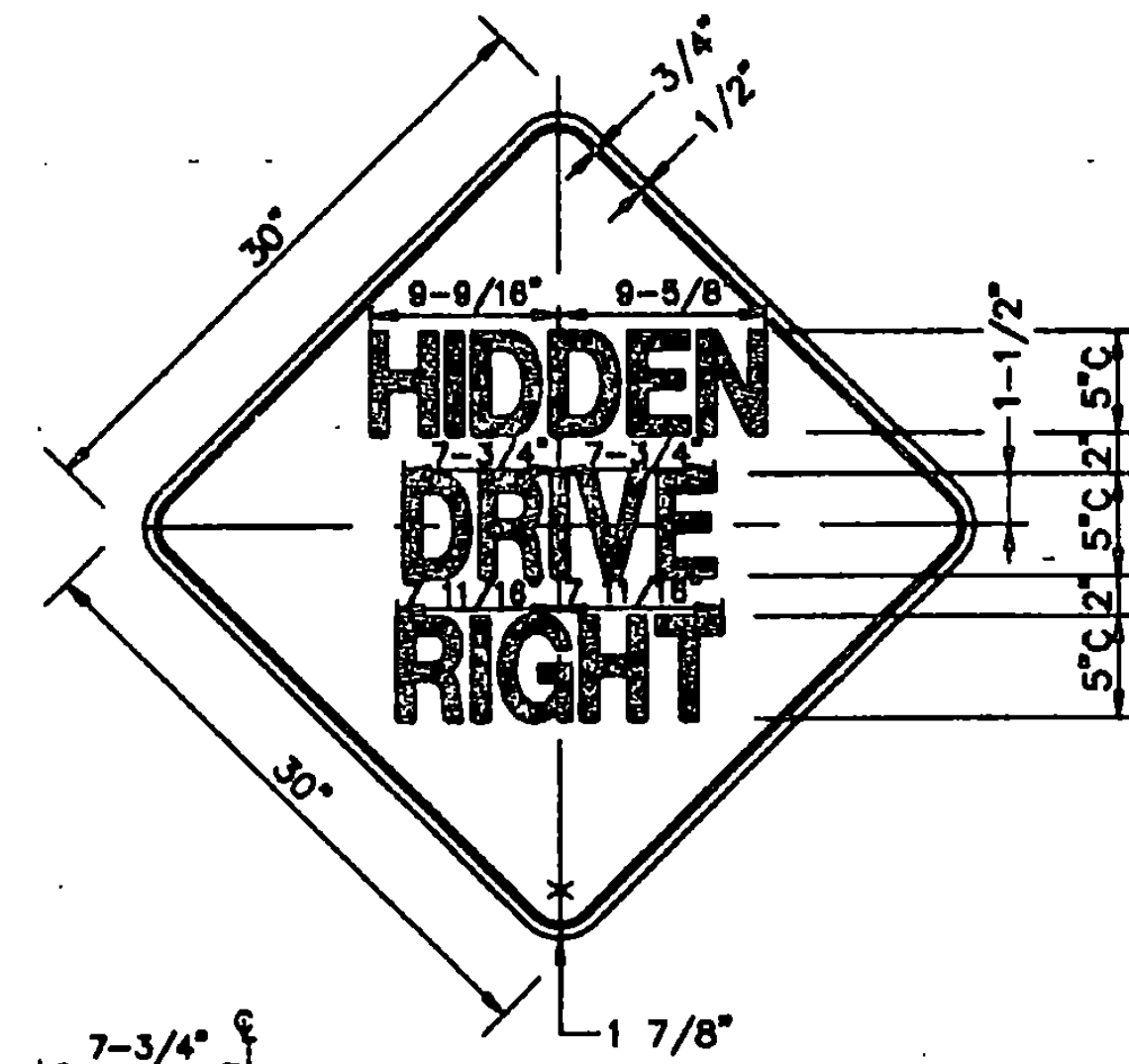

COLORS AND MATERIALS SHALL BE IN ACCORDANCE WITH E-151

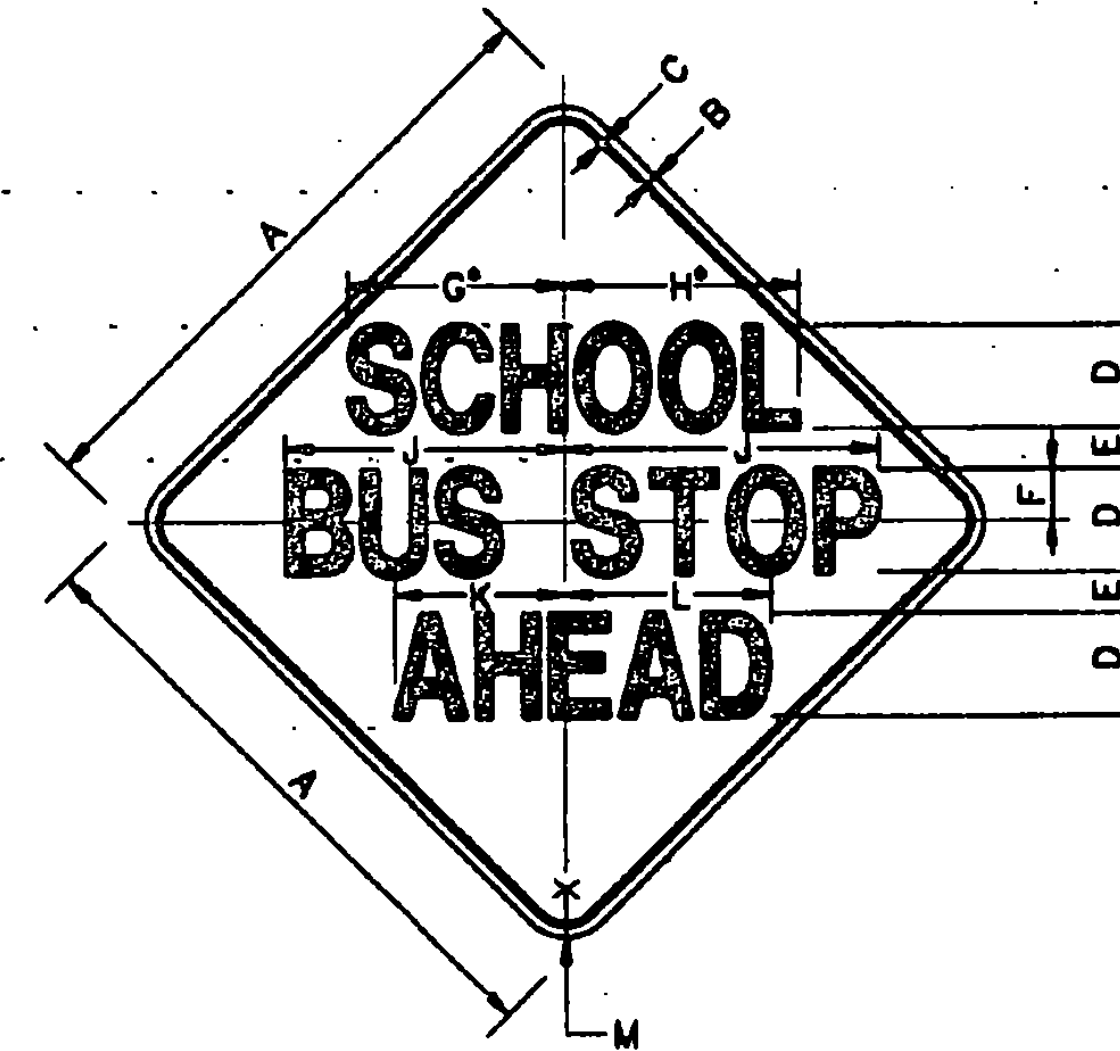
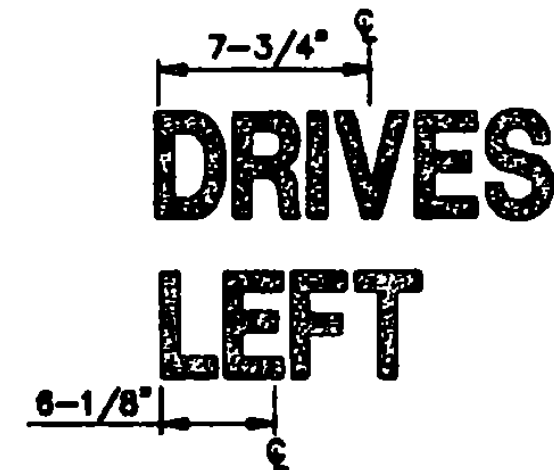

COLORS AND MATERIALS SHALL BE IN ACCORDANCE WITH E-151

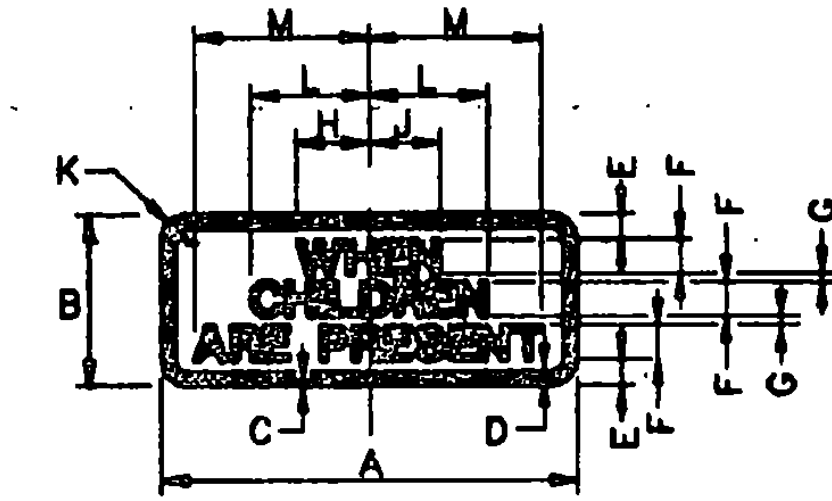

SIGN	DIMENSIONS (INCHES)							
	A	B	C	D	E	F	G	H
STD.	24	10	3/8	5/8	1 1/2	2D	1/2	3 1/2

J	K	L	M
3 5/16	1-1/2	6 1/4	9 5/16

COLORS AND MATERIALS SHALL BE IN ACCORDANCE WITH E-151

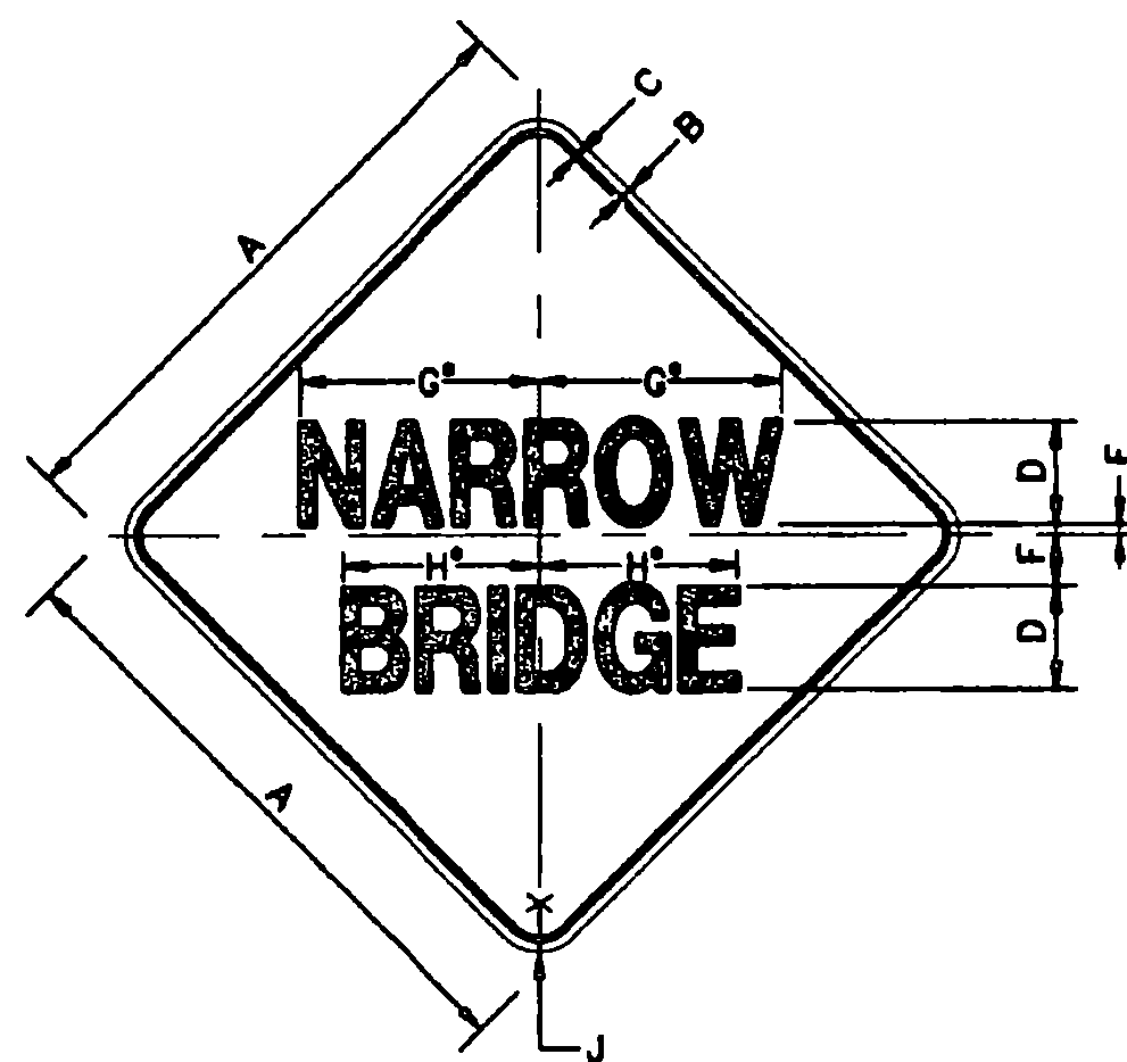

* REDUCE SPACING 20%

SIGN	DIMENSION (INCHES)									
	A	B	C	D	E	F	G	H	J	
STD.	30	1/2	3/4	5D	1/2	2 1/2	13 1/16	10 7/8	1 7/8	

COLORS AND MATERIALS SHALL BE IN ACCORDANCE WITH E-151

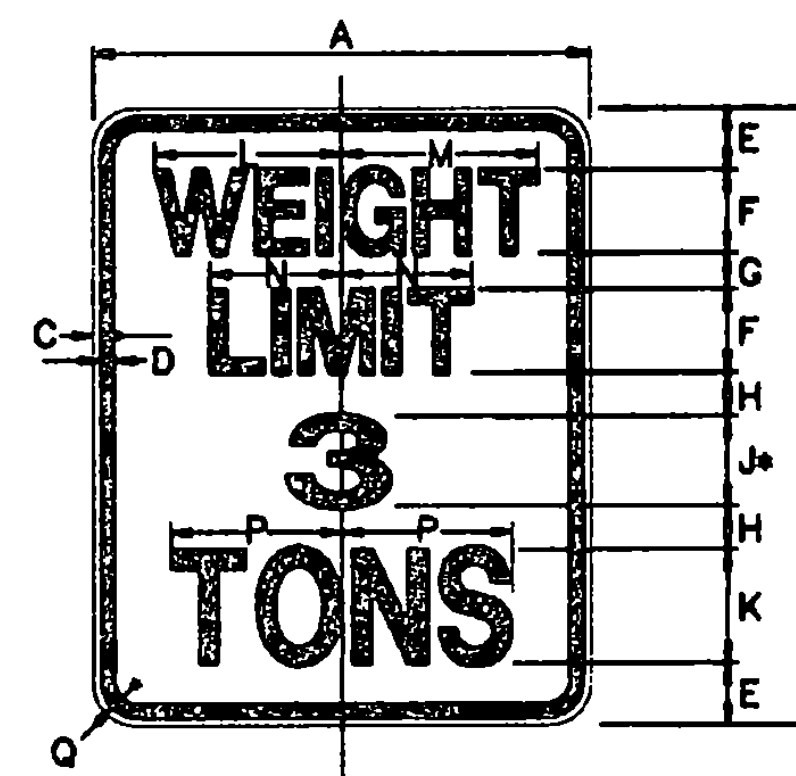

* OPTICALLY SPACE NUMERALS ABOUT VERTICAL CENTERLINE.

SIGN	DIMENSION (INCHES)																
	A	B	C	D	E	F	G	H	J	K	L	M	N	P	Q		
MIN. & STD.	24	30	3/8	5/8	3	4D	1-3/4	2-1/8	5E	5D	9	9-1/2	6-5/16	8-1/4	1-1/2		

COLORS AND MATERIALS SHALL BE IN ACCORDANCE WITH E-144

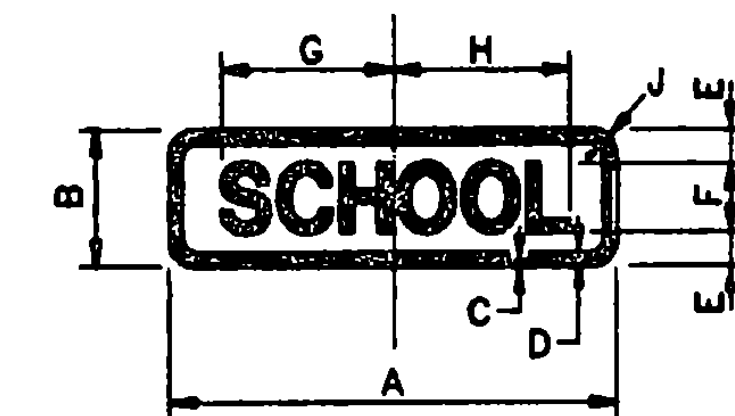

SIGN	DIMENSIONS (INCHES)									
	A	B	C	D	E	F	G	H	J	
STD.	24	8	3/8	5/8	2	4D	10	10-1/4	1-1/2	

COLORS AND MATERIALS SHALL BE IN ACCORDANCE WITH E-151

DATUM
VERTICAL _____
HORIZONTAL N/A

NOTE:

TEXT LAYOUT DIMENSIONS ARE BASED ON THE "LETTER & NUMERAL WIDTHS AND SPACE" TABLES FOUND IN THE "STANDARD HIGHWAY SIGNS" BOOKLET. MINOR VARIATIONS IN TEXT DIMENSIONS ARE ACCEPTABLE BASED ON INDIVIDUAL MANUFACTURER'S LETTER FABRICATION. SIGNIFICANT CHANGES WHICH AFFECT SIGN APPEARANCE SHALL BE BROUGHT TO THE ATTENTION OF THE VAOT'S TRAFFIC AND SAFETY DIVISION BEFORE FABRICATION.

NOT TO SCALE

SIGN DETAILS
I

SURVEYED BY N/A DATE N/A
DRAWN BY TLB DATE 12/93
SQUAD LEADER SJB
DESIGN FILE NO. _____
SPARM FILE _____ DATE PLOTTED _____
PROJ. NAME NORTHFIELD-BERLIN
PROJ. NO. STP SIGN 9467
SHEET 35 OF 39 SHEETS