

COLORS: BACKGROUND - REFL. ORANGE  
TEXT & BORDER - BLACK

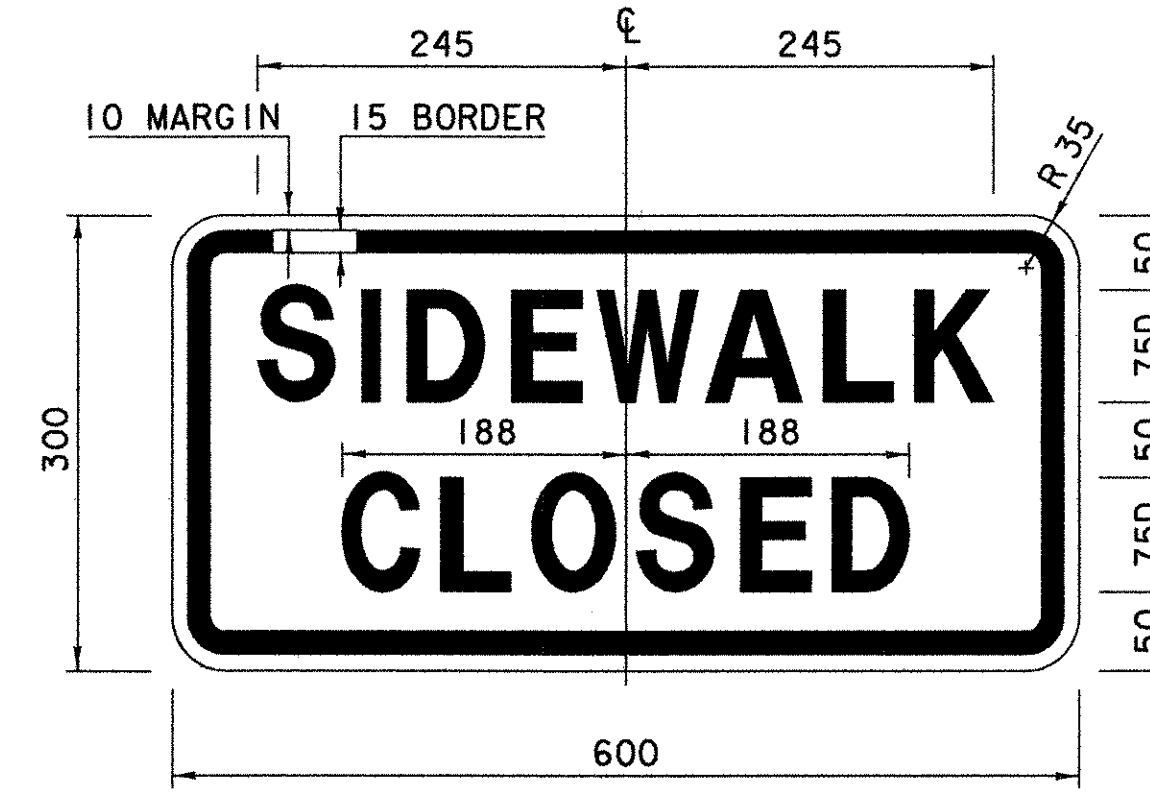

R9-9  
COLORS: BACKGROUND - REFL. WHITE  
TEXT & BORDER - BLACK

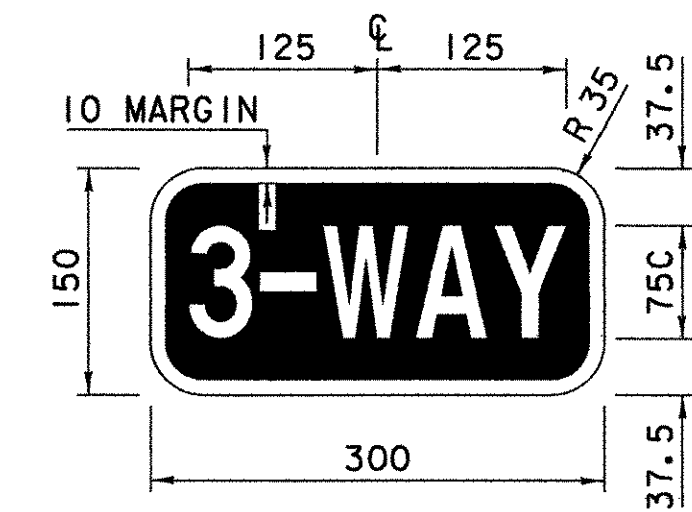

R1-3  
COLORS: BACKGROUND - REFL. RED  
TEXT & BORDER - REFL. WHITE

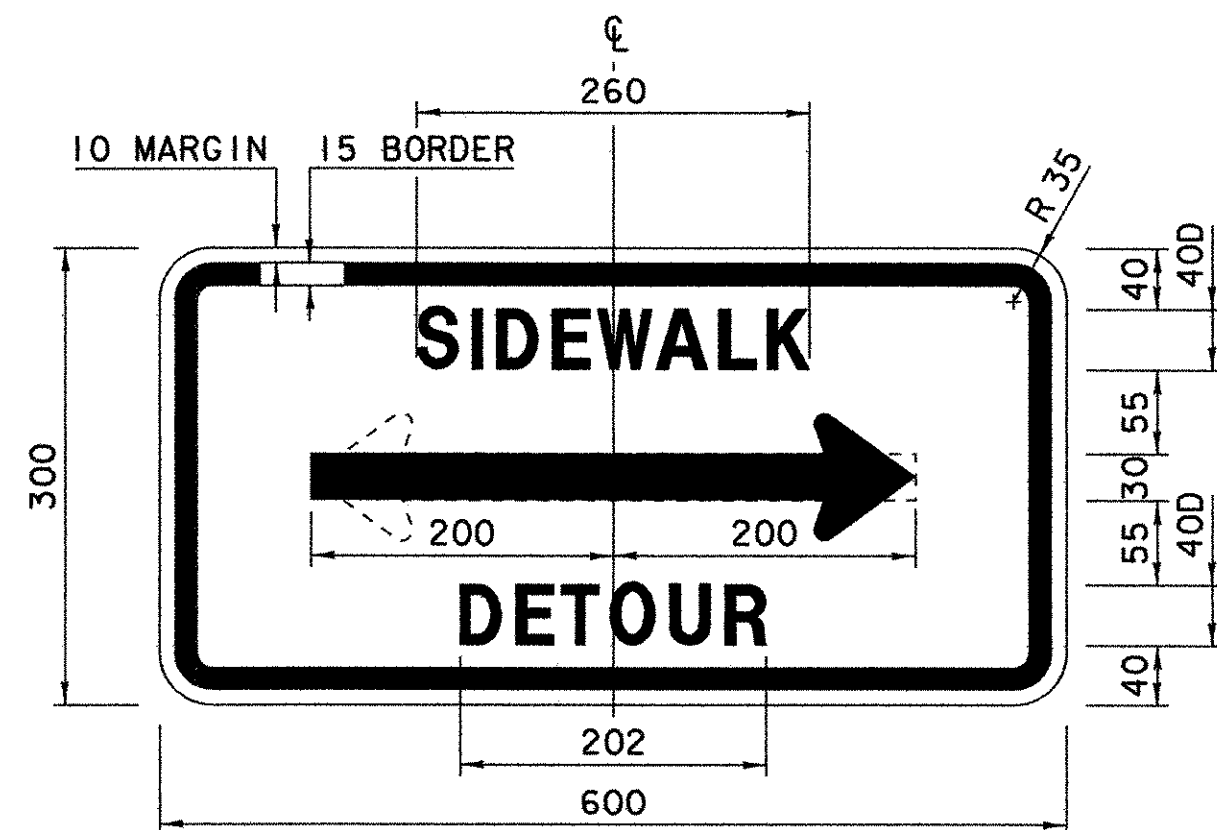

COLORS: BACKGROUND - REFL. ORANGE  
TEXT & BORDER - BLACK

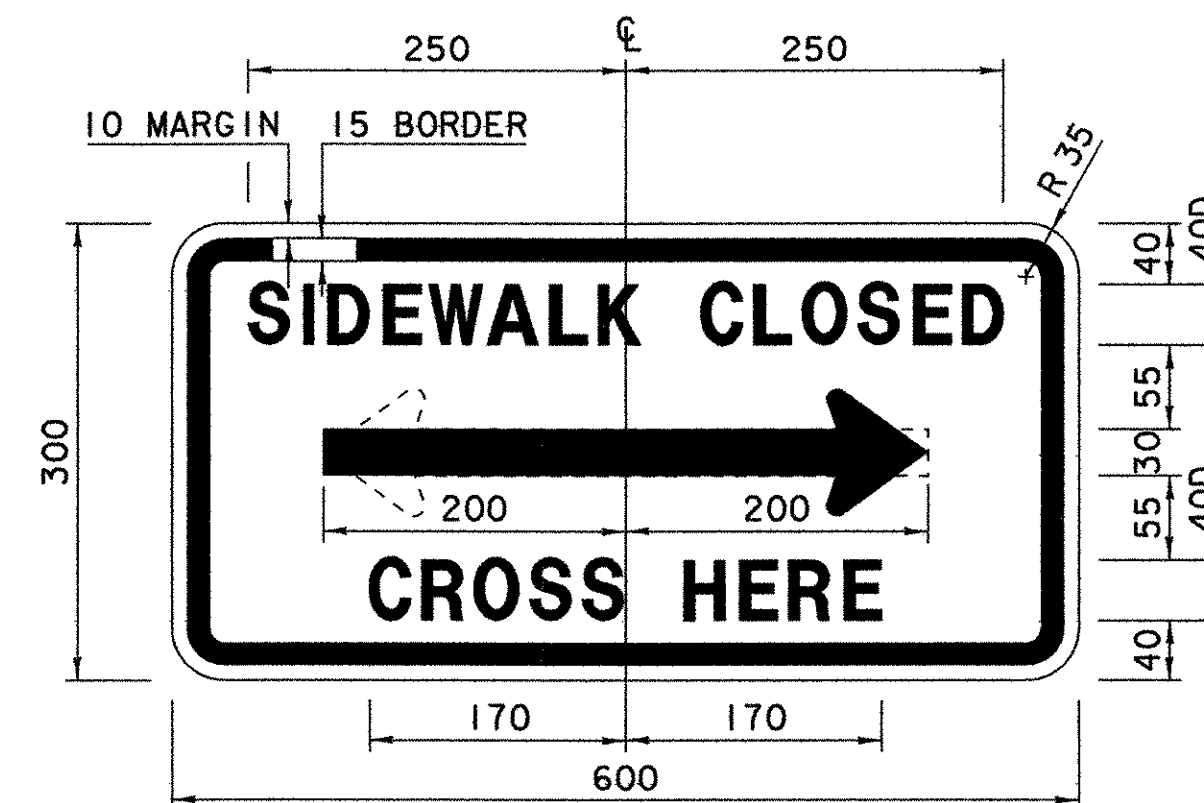

R9-11a  
COLORS: BACKGROUND - REFL. WHITE  
TEXT & BORDER - BLACK

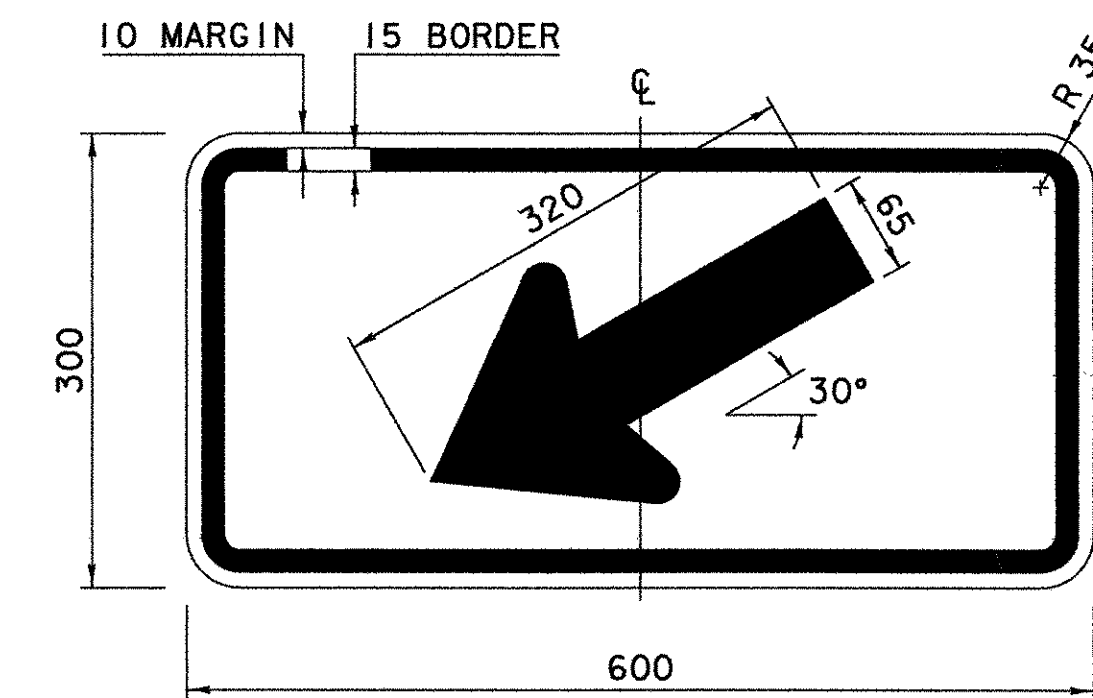

W16-7P  
COLORS: BACKGROUND - REFL. ORANGE  
TEXT & BORDER - BLACK

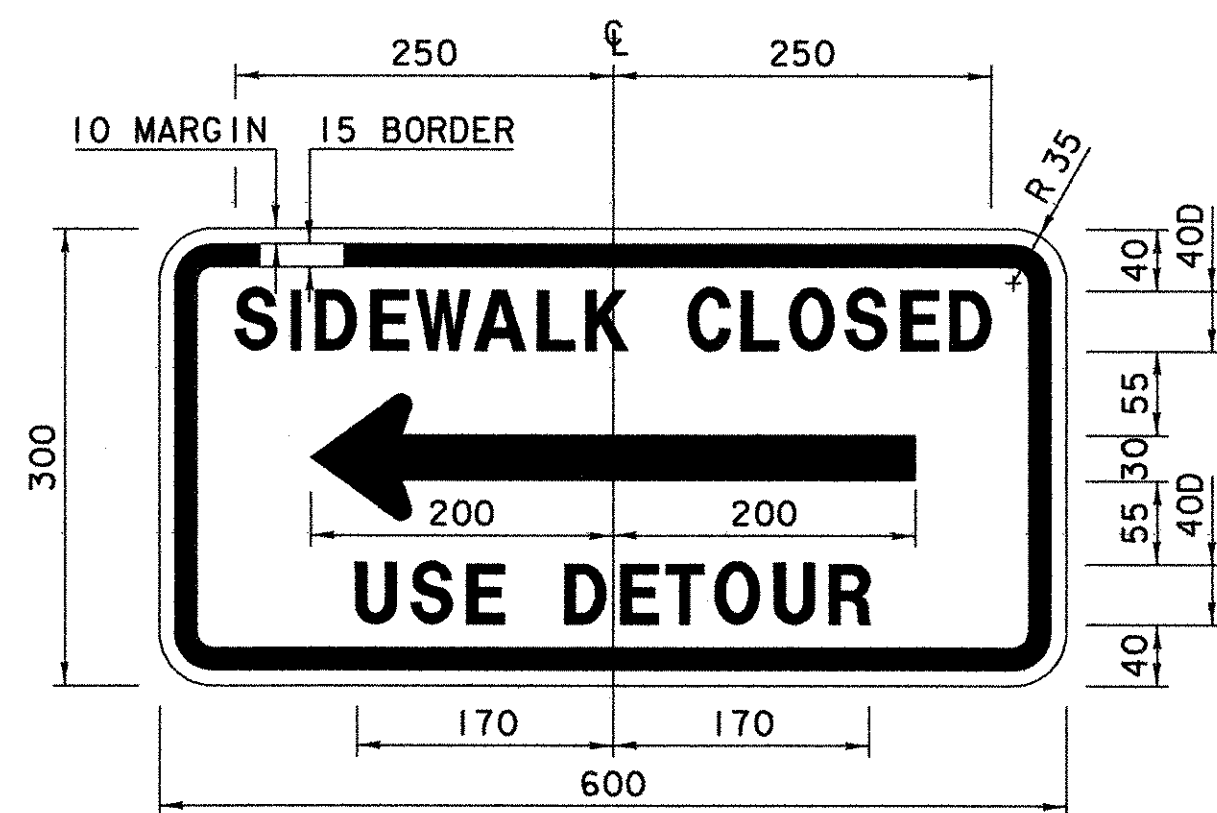

COLORS: BACKGROUND - REFL. WHITE  
TEXT & BORDER - BLACK

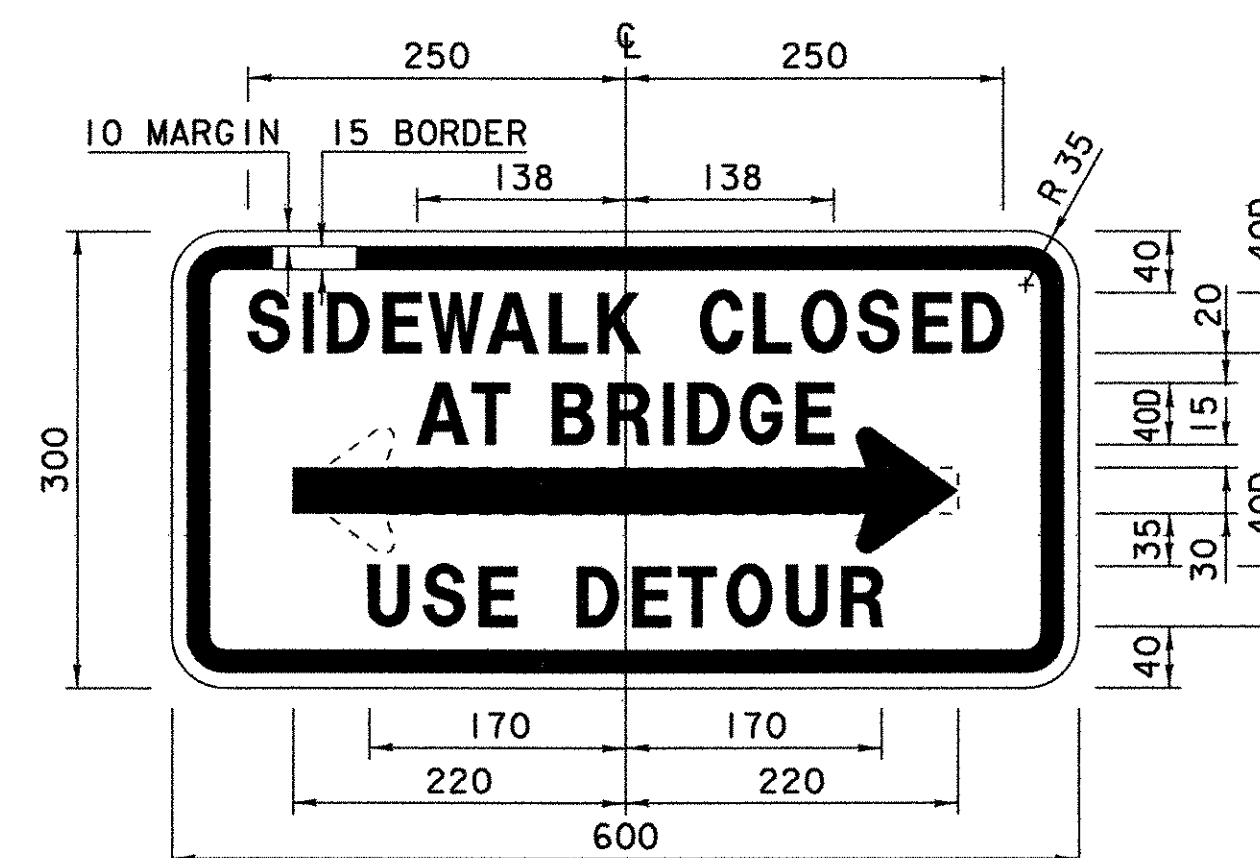

COLORS: BACKGROUND - REFL. WHITE  
TEXT & BORDER - BLACK

TEXT LAYOUT DIMENSIONS ARE BASED ON THE "LETTER & NUMERAL WIDTHS AND SPACE" TABLES FOUND IN THE "STANDARD HIGHWAYS SIGNS" BOOKLET. MINOR VARIATIONS IN TEXT DIMENSIONS ARE ACCEPTABLE BASED ON INDIVIDUAL MANUFACTURER'S LETTER FABRICATION. SIGNIFICANT CHANGES WHICH AFFECT SIGN APPEARANCE SHALL BE BROUGHT TO THE ATTENTION OF THE VAOT'S TRAFFIC DESIGN UNIT BEFORE FABRICATION.

SEE STD.E-100M FOR SIGN MATERIALS.

CONSTRUCTION SIGN DETAIL (2)

PROJECT NAME:	BRATTLEBORO		
PROJECT NUMBER:	BHF 2000 (17)		
FILE NAME:	94J078\Structures\s\j078csd2.l	PLOT DATE:	24-MAY-2004
PROJECT MANAGER:	R. R. WHITCOMB	DRAWN BY:	G. ROY
DESIGNED BY:	G. ROY	CHECKED BY:	T. SUMNER
			SHEET 25 OF 71

DATE	BY	REVISION
04/22/2003	VAOT	MODIFIED SIGNS FOR DETOUR DUE TO BRIDGE CLOSURE.