

W11A-2

SIGN	DIMENSIONS (INCHES)										
	A	B	C	D	E	F	G	H	J		
BIKE	18	3/8	3/8	8 3/8	4 3/4	3/4	2 3/8	3 3/8	1 1/2		
MIN.	24	3/8	3/8	11	6 3/8	1 1/8	3 1/8	4 3/8	1 1/2		
STD.	30	1/2	3/4	14	8	1 1/2	4	6	1 3/8		
EXPWY.	36	5/8	7/8	16 3/4	9 5/8	1 3/4	4 3/4	7 1/4	2 1/4		
SPECIAL	48	3/4	1 1/4	22	12 3/4	2 3/8	6 1/4	9 1/2	3		

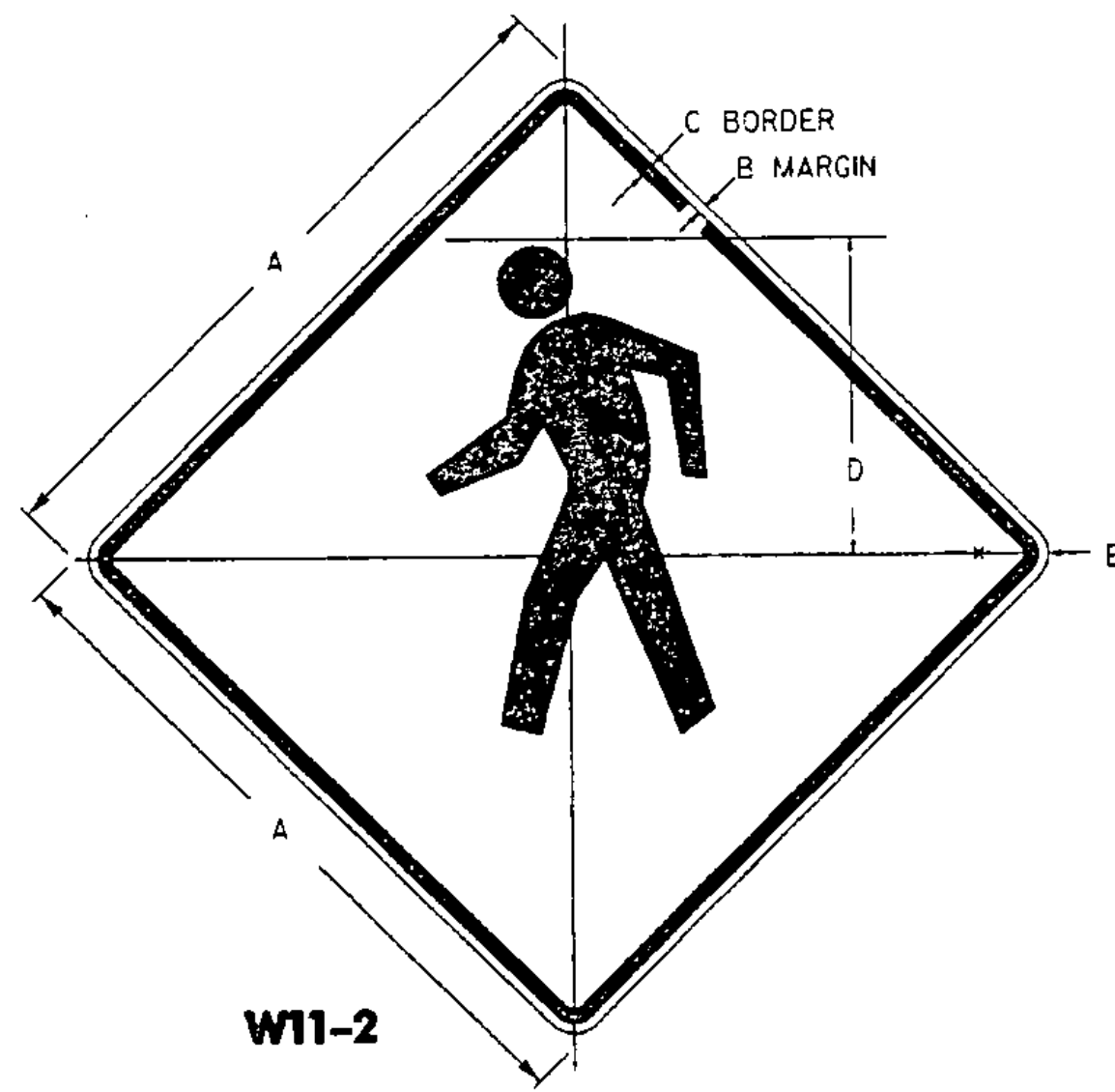

W11-2

SIGN	DIMENSIONS (INCHES)				
	A	B	C	D	E
MIN.	24	3/8	5/8	11	1 1/2
STD.	30	1/2	3/4	13 1/2	1 7/8
EXPWY.	36	5/8	7/8	16	2 1/4
SPECIAL	48	3/4	1 1/4	22	3

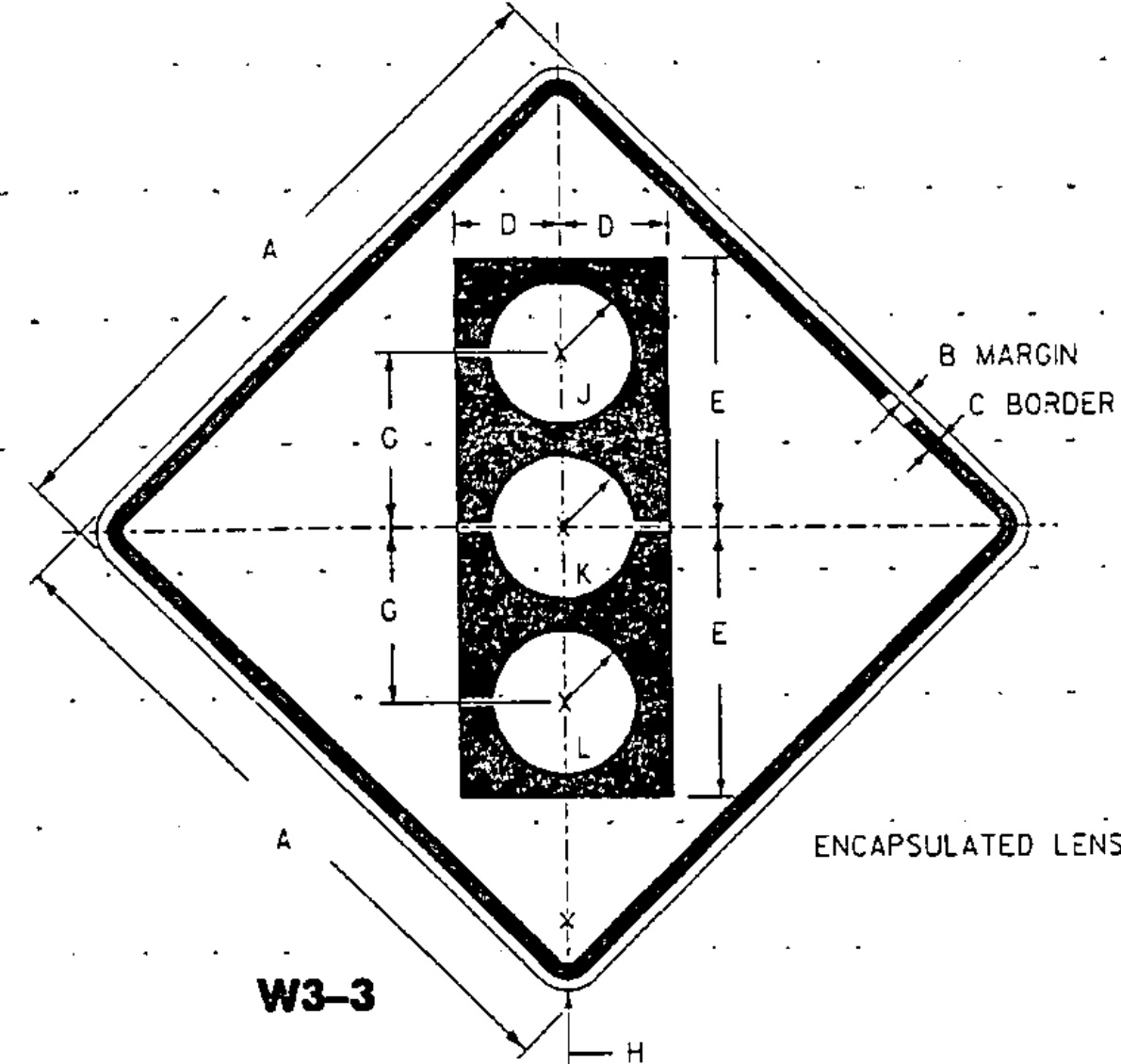
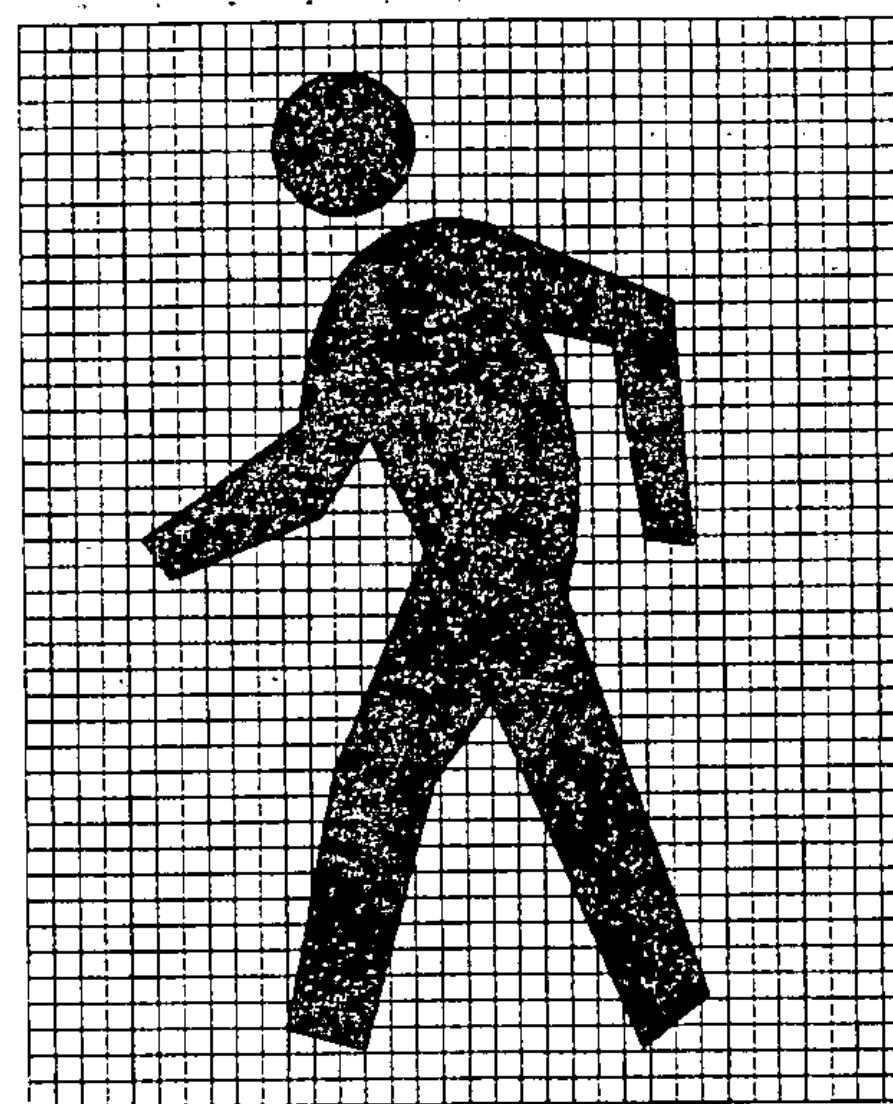

W3-3

SIGN	DIMENSIONS (INCHES)							
	A	B	C	D	E	F	G	H
BIKE	18	3/8	3/8	3	8	2 1/4	5	1 1/2
MIN.	30	1/2	3/4	5	13 3/4	3 3/4	8 3/4	1 1/8
STD. & MIN.	36	5/8	7/8	5 3/4	15 3/4	4 1/4	10	2 1/4
SPECIAL	48	3/4	1 1/4	7 1/2	20	5	12 1/2	3

ADDITIONAL COLORS : J - REFL. RED
K - REFL. YELLOW
L - REFL. GREEN
CIRCLE RADIUS = F

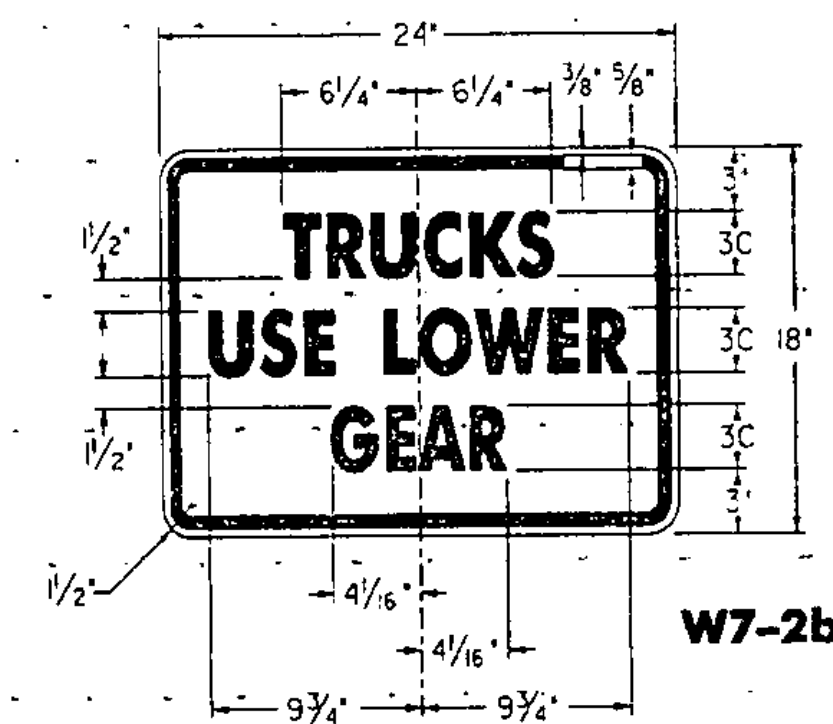

W7-2b

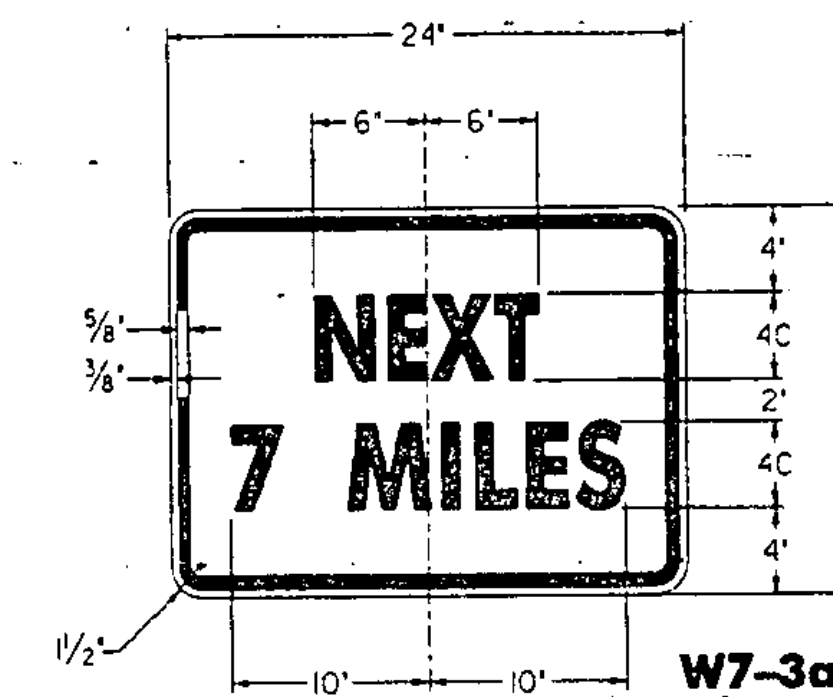

W7-3a

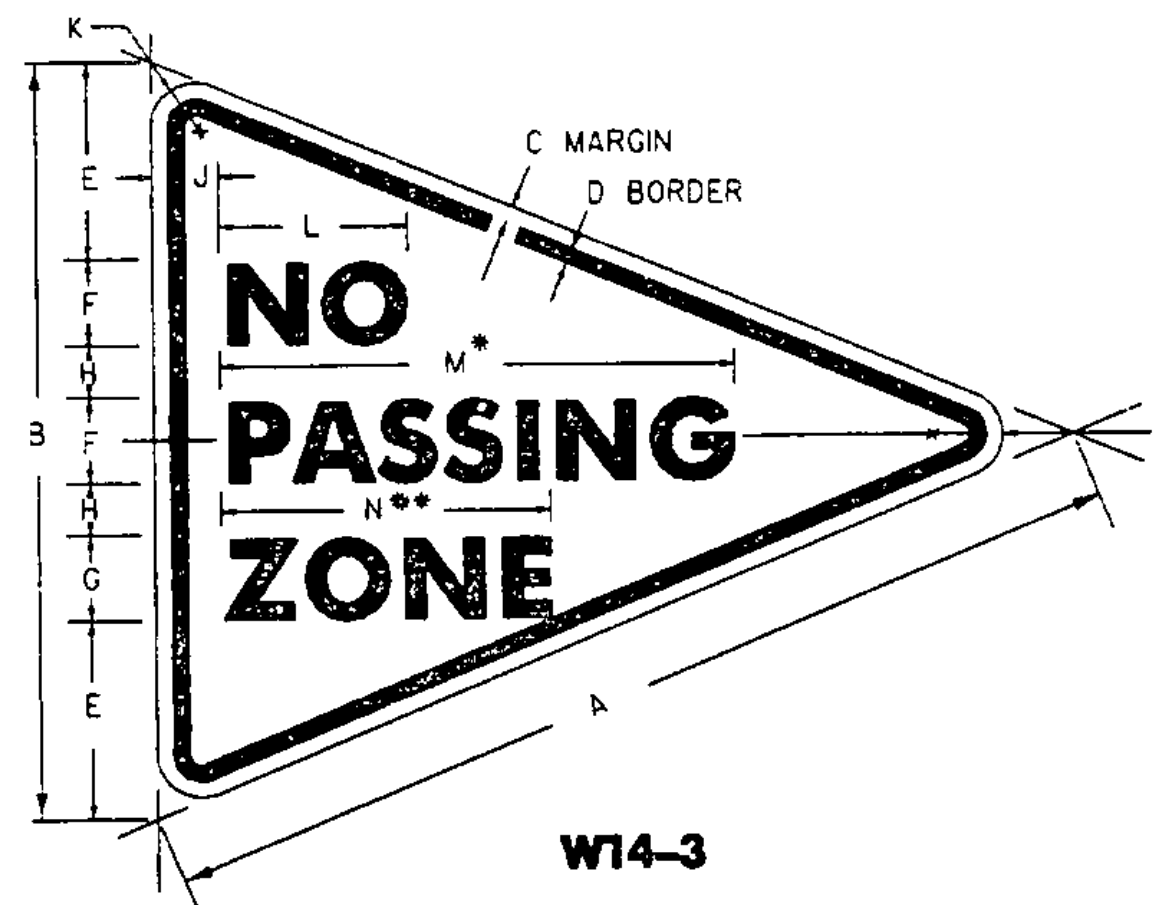

W14-3

SIGN	DIMENSIONS (INCHES)													
	A	B	C	D	E	F	G	H	J	K	L	M	N	
MIN.	40	30	1/2	3/4	7 1/4	40	4C	1 3/4	2 1/2	1 1/8	6 1/2	22 3/8	11 1/8	
STD.	48	36	5/8	7/8	8 1/2	50	5C	2	3	2 1/4	8	26 1/8	12 3/4	
SPECIAL	64	48	3/4	1 1/4	12	60	6C	3	4	3	10 3/4	33 1/8	16 3/8	

** FOR STD. SIZE REDUCE SPACING 35 %
* FOR STD. SIZE REDUCE SPACING 20 %

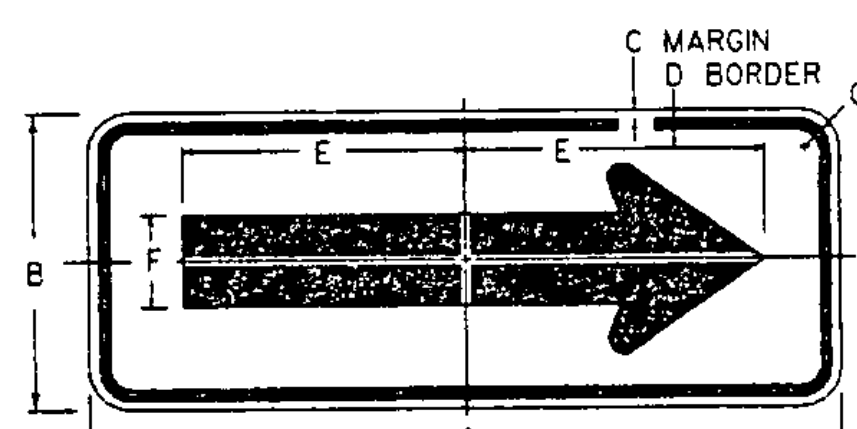

W1-6

SIGN	DIMENSIONS (INCHES)							
	A	B	C	D	E	F	G	H
BIKE	24	12	3/8	3/8	9 3/8	3 1/4	1 1/2	10 3/8
MIN.	36	18	3/8	3/8	14 3/8	5	1 1/2	15 3/8
STD.	48	24	1/2	3/4	19 1/2	6 1/2	1 7/8	20 1/2
SPECIAL	60	30	5/8	7/8	24 3/8	8	2 1/4	25 3/8

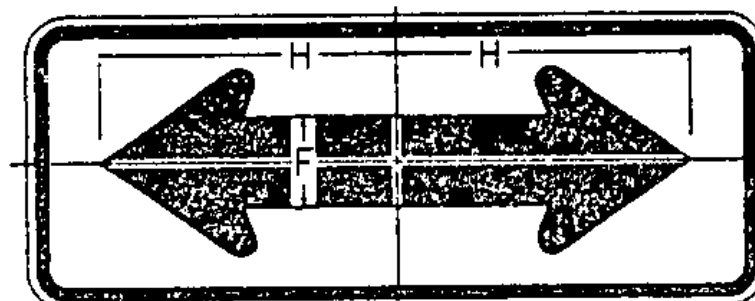

W1-7

ENCAPSULATED LENS

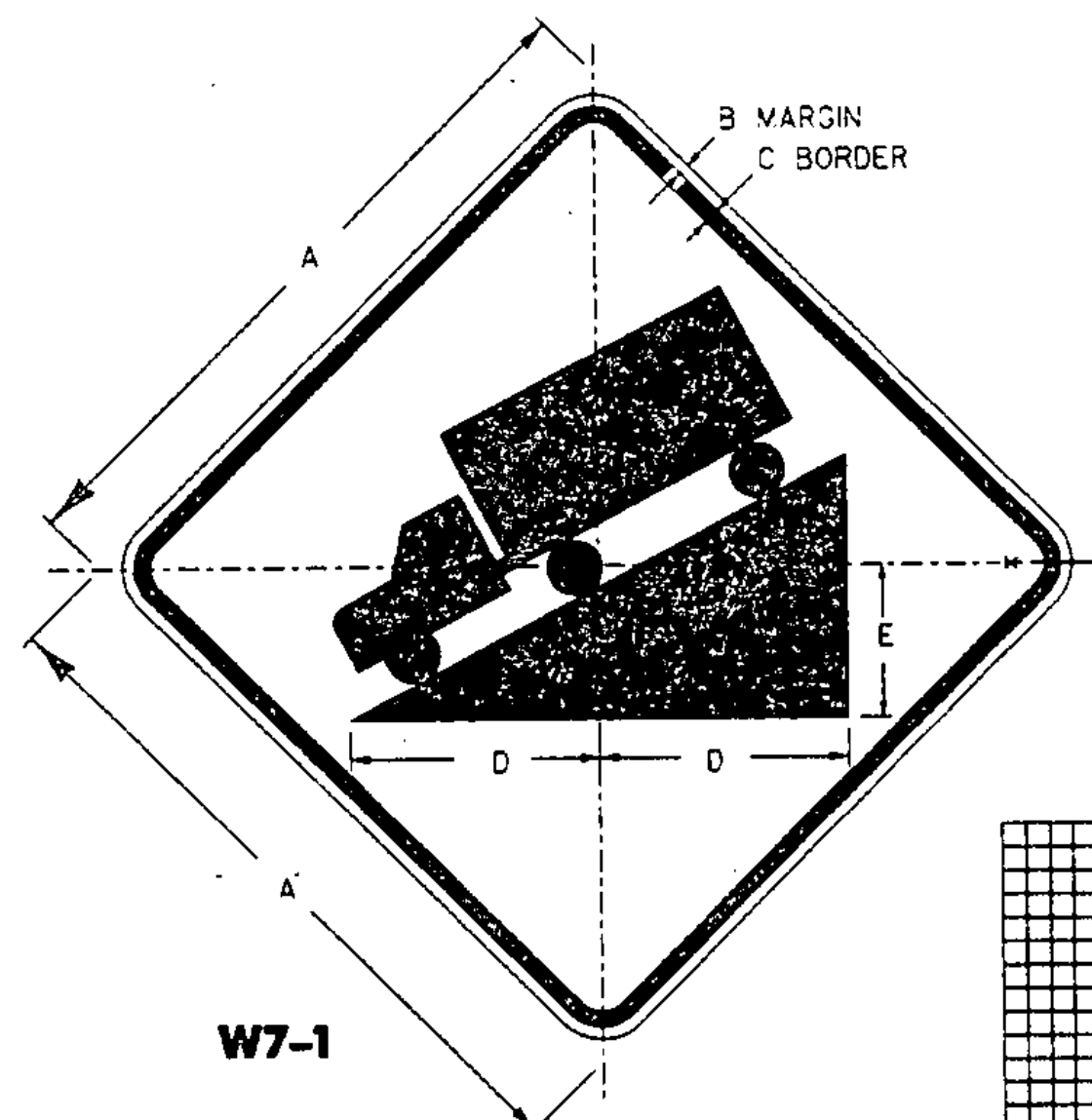

W7-1

SIGN	DIMENSIONS (INCHES)					
	A	B	C	D	E	F
MIN.	24	3/8	3/8	8 3/4	6	1 1/2
STD.	30	1/2	3/4	11	7 1/2	1 7/8
EXPWY.	36	5/8	7/8	13 3/4	9	2 1/4
FWY.	48	3/4	1 1/4	17 1/2	12	3

ENCAPSULATED LENS

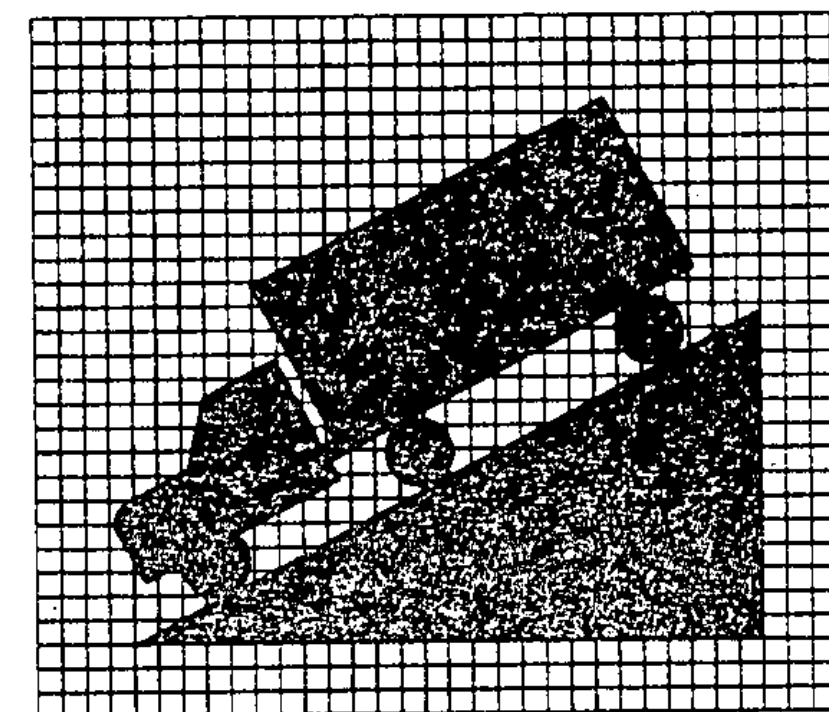

COLORS

ALL THE WARNING SIGNS SHOWN ON THIS SHEET SHALL HAVE BLACK TEXT AND SYMBOLS ON REFLECTORIZED YELLOW BACKGROUND EXCEPT AS OTHERWISE NOTED. THE COLORS SHALL CONFORM WITH THE COLORS ADOPTED BY THE AMERICAN ASSOCIATION OF STATE HIGHWAY AND TRANSPORTATION OFFICIALS AND APPROVED BY THE DEPARTMENT OF TRANSPORTATION, FEDERAL HIGHWAY ADMINISTRATION.

MATERIALS

THE SIGN BASE MATERIALS USED FOR THE WARNING SIGNS SHOWN ON THIS SHEET MAY BE ANY OF THE FOLLOWING, OF THE MINIMUM THICKNESS NOTED.

	18" x 18"	24" x 12"	36" x 18"	48" x 24"	48" x 36"	48" x 48"	60" x 30"	64" x 48"
FLAT SHEET ALUMINUM	0.060"	0.080"	0.080"	0.100"	0.125"	0.125"	0.125"	0.125"
HIGH DENSITY OVERLAID PLYWOOD	1/2"	1/2"	1/2"	1/2"	1/2"	1/2"	1/2"	1/2"
GALVANIZED FLAT SHEET STEEL	18 GAGE	16 GAGE	14 GAGE	12 GAGE	12 GAGE	12 GAGE	12 GAGE	12 GAGE

THE TEXT, BORDER AND SYMBOLS SHALL BE LETTERING FILM, SILK SCREENED OR HAND PAINTED. WHEN HAND PAINTED, POOR WORKMANSHIP SHALL BE CAUSE FOR REJECTION. THE REFLECTIVE MATERIAL SHALL BE REFLECTIVE SHEETING APPLIED TO THE ENTIRE BACKGROUND OF THE SIGN. ENCAPSULATED LENS REFLECTIVE SHEETING SHALL BE USED FOR THE SIGN BACKGROUND WHERE NOTED.

TEXT DESIGN

LETTERS, DIGITS, SYMBOLS, SPACINGS, AND TEXT DIMENSIONS SHALL CONFORM WITH THE STANDARD ALPHABETS AND DESIGNS PRESCRIBED IN THE MANUAL ON UNIFORM TRAFFIC CONTROL DEVICES. SEE STANDARD SHEET E-150 FOR ARROWHEAD DETAILS.

SPECIFICATIONS

WARNING SIGNS SHALL MEET THE VERMONT STANDARD SPECIFICATIONS FOR "TRAFFIC SIGNS".

OTHER STDS. E-150 REQUIRED:

REVISIONS AND CORRECTIONS

OCT. 30, 1987 - DATE OF ORIGINAL ISSUE
JANUARY 1991 - 4 X 2 ARROW ENCAPSULATED LENS & 40 X 30 ADDED
OCT. 21, 1992 - PENNANT SIZE ADDED
AUG. 08, 1995 - DELETED & ADDED SIGN DETAILS AND ADDED I.D. NUMBER TO EACH DETAIL

APPROVED FOR THIS PROJECT AND/OR DESIGN IMPLEMENTATION. FHWA FINAL APPROVAL PENDING.

APPROVED

Smith, D. J. McArthur
DIRECTOR OF ENGINEERING

David A. Ross
TRAFFIC AND SAFETY ENGINEER

WARNING SIGN
DETAILS

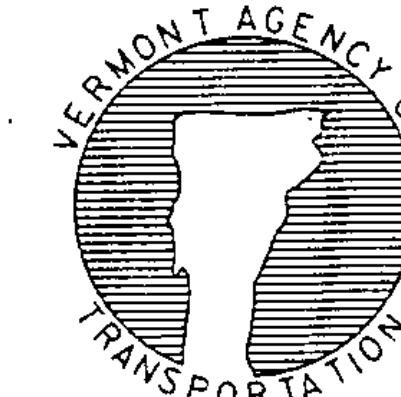

STANDARD
E-152