

TOP CHORD "U1-3"

C10x20x31'-10 5/16" (EXISTING)
 C10x20x31'-10 5/16" (EXISTING)
 PL 5/8 x 17 x 31'-10 5/16" (NEW)

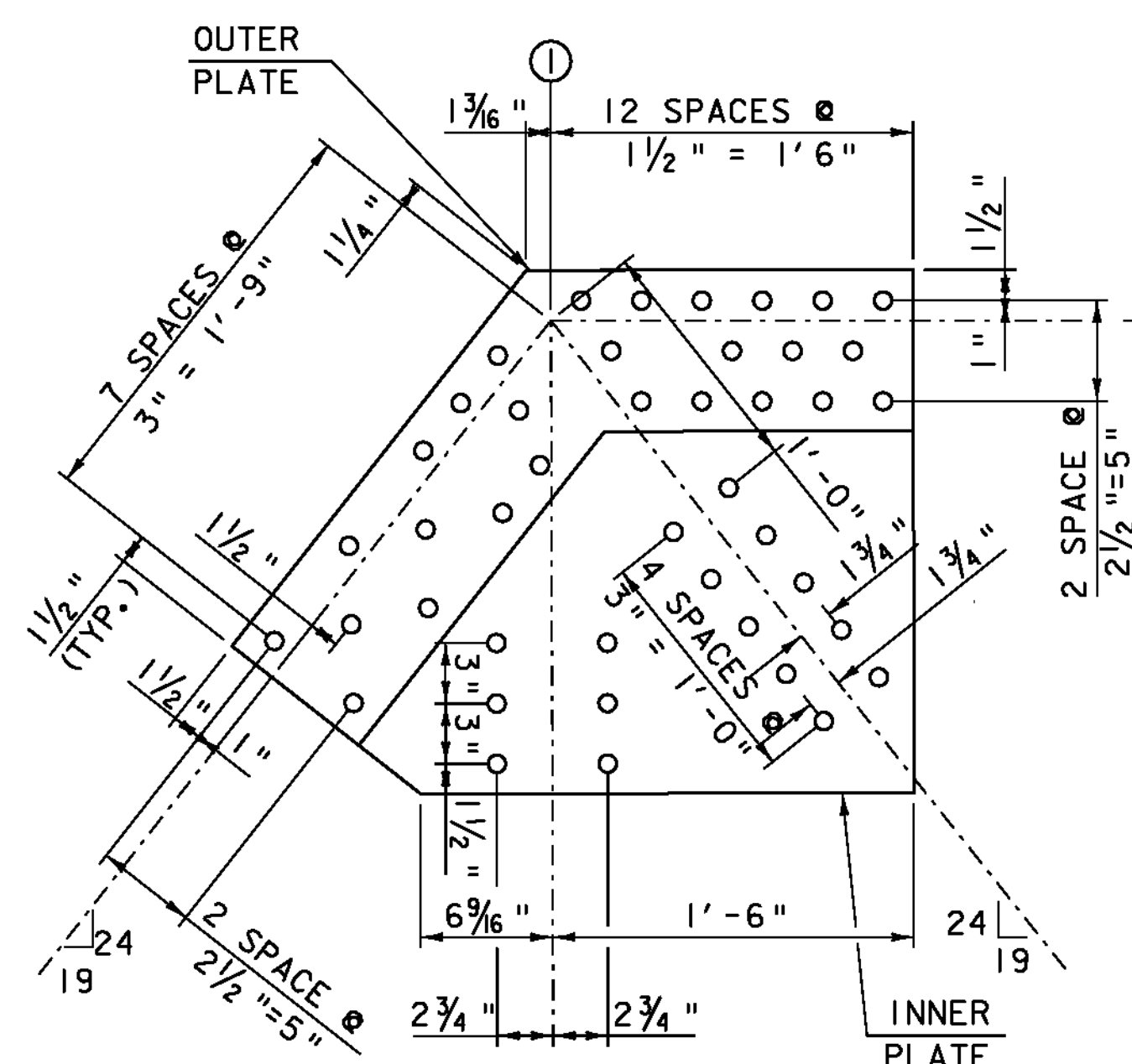
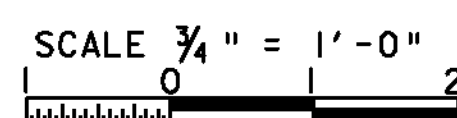

UI PLATES DETAIL

2 PL 3/8 x 26 x 2'-10" (INNER) (CVN)
 2 PL 3/8 x 16 1/2 x 3'-3" (OUTER) (CVN)

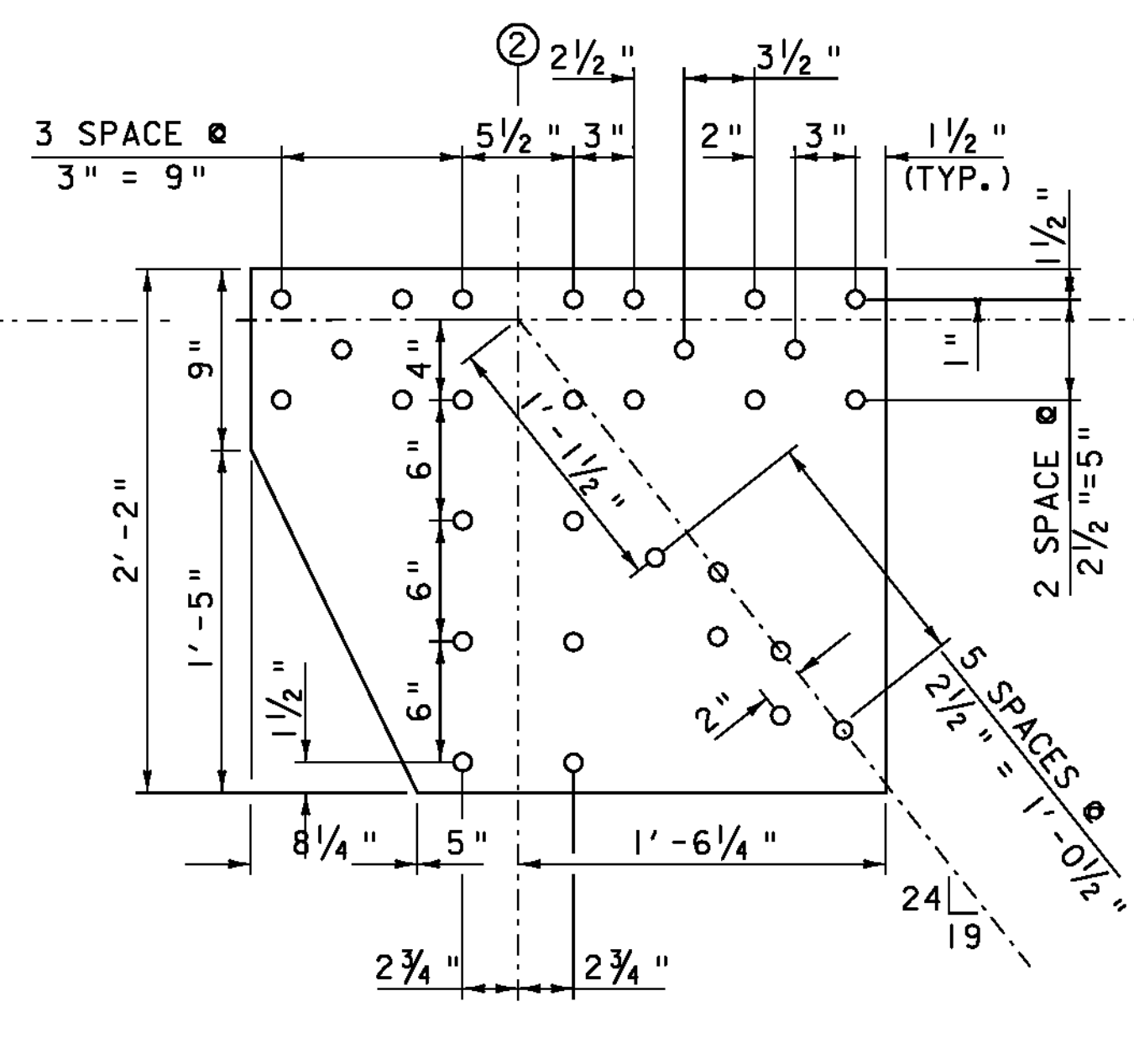
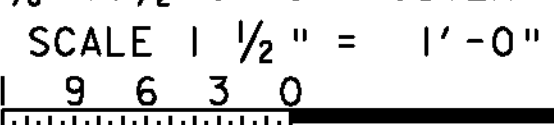

U2 PLATES DETAIL

2 PL 3/8 x 26 x 2'-7 1/2" (CVN)

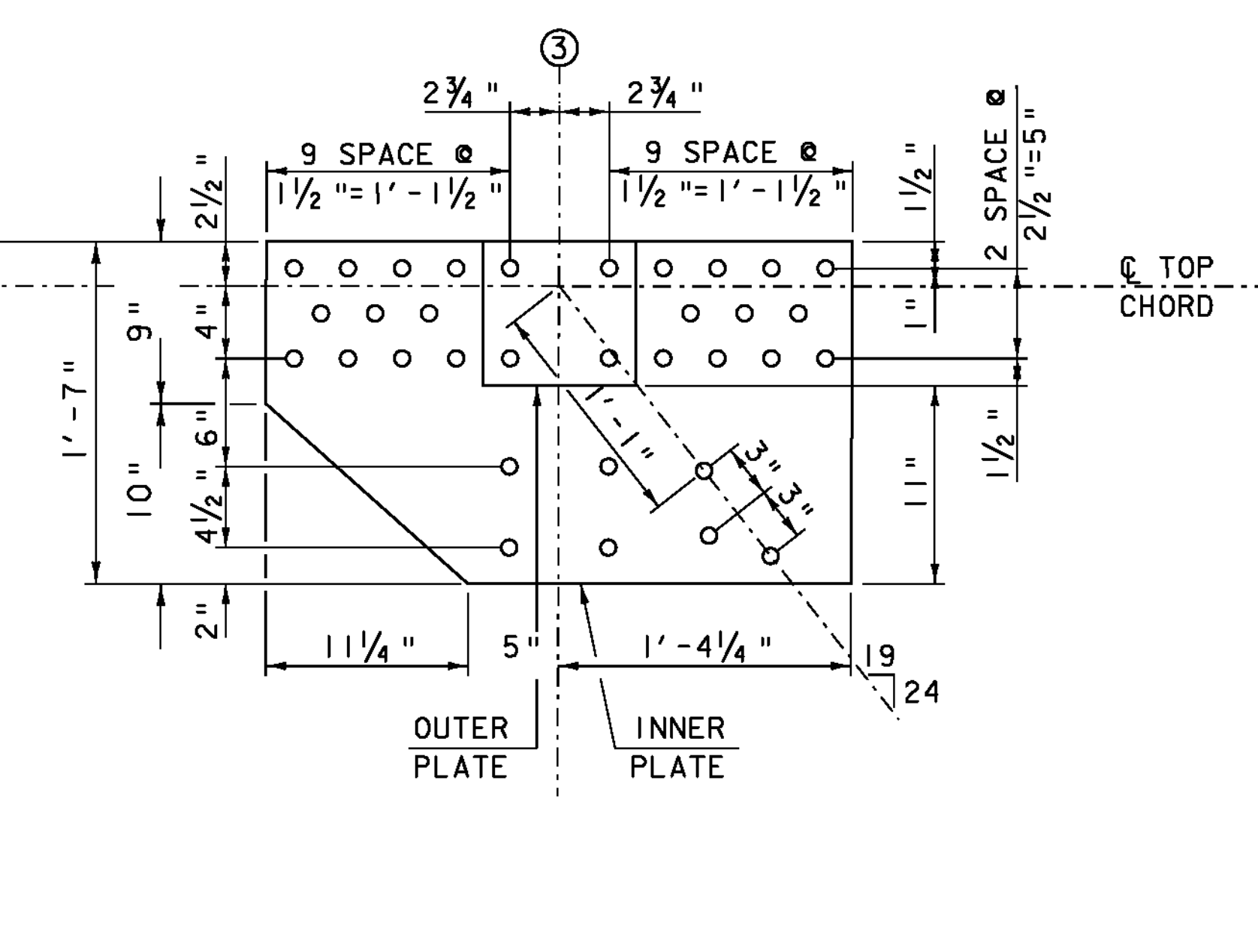
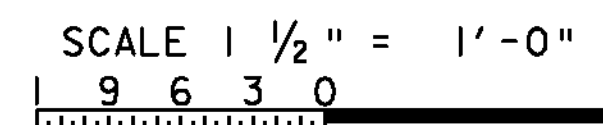

U3 PLATES DETAIL

2 PL 3/8 x 19 x 2'-8 1/2" (CVN) (INNER)
 2 PL 3/8 x 8 x 8 1/2" (CVN) (OUTER)

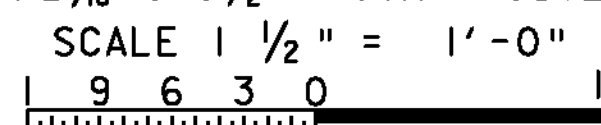

MIN. BOLT HOLE END AND EDGE DISTANCE 1 1/2" UNLESS NOTED
 7/8" DIA. BOLTS UNLESS NOTED
 5/8" DIA. HOLES UNLESS NOTED

PROJECT NAME: BRIDGEWATER	PLOT DATE: 25-JAN-2010
PROJECT NUMBER: BRS 0149(4)	DRAWN BY: C. MOONEY
FILE NAME: s86e062truss.dgn	CHECKED BY: T. FILLBACH
PROJECT LEADER: K. HIGGINS	SHEET 27 OF 58
DESIGNED BY: T. FILLBACH	
TOP CHORD 'U1-3'	