

VT 114

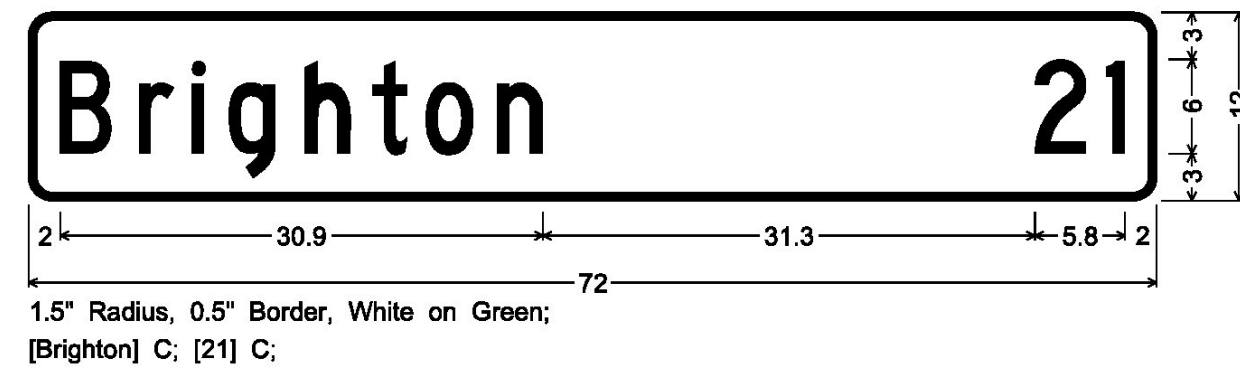

ALL SIGNS IN THIS SECTION ARE SIGNS CODE VD2-1

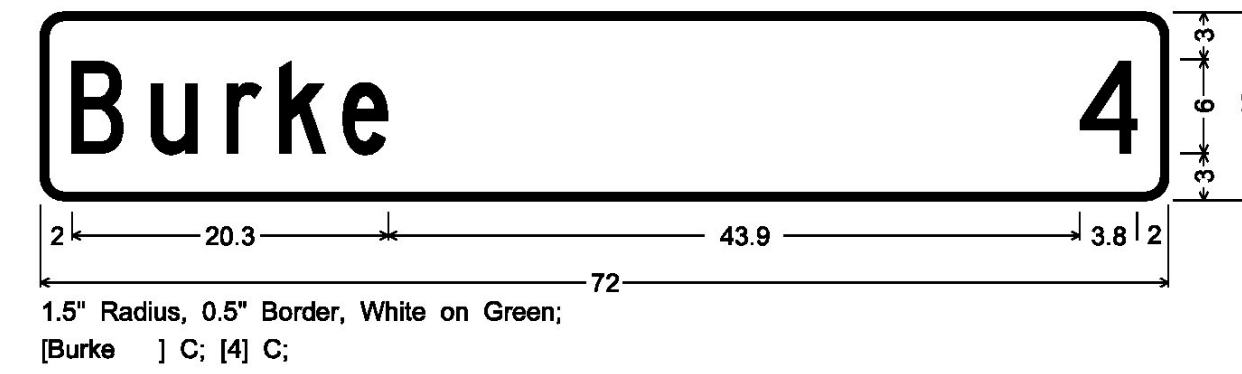
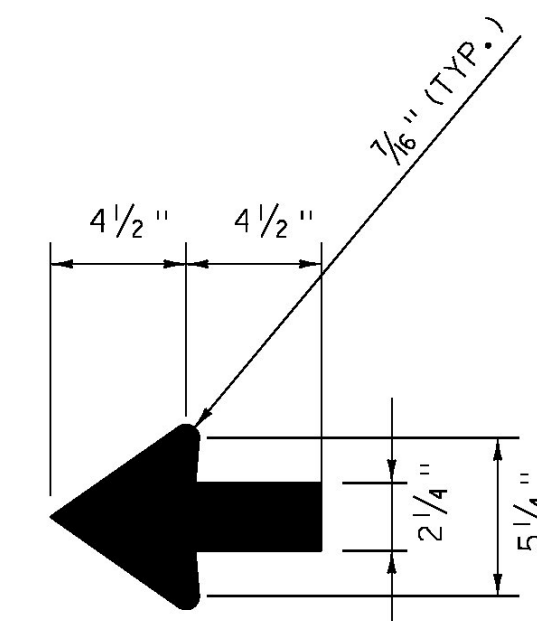
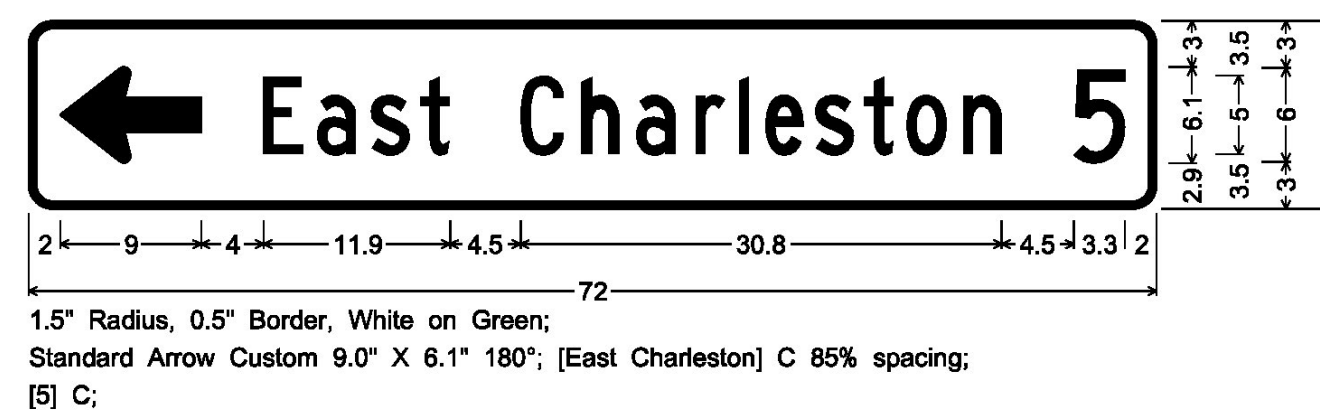
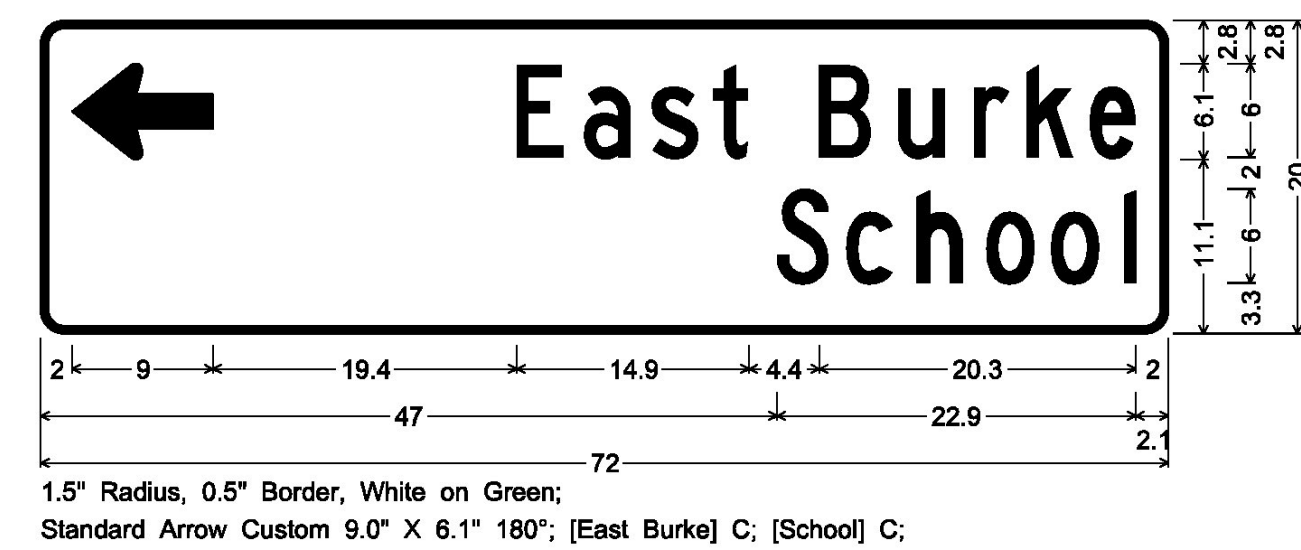
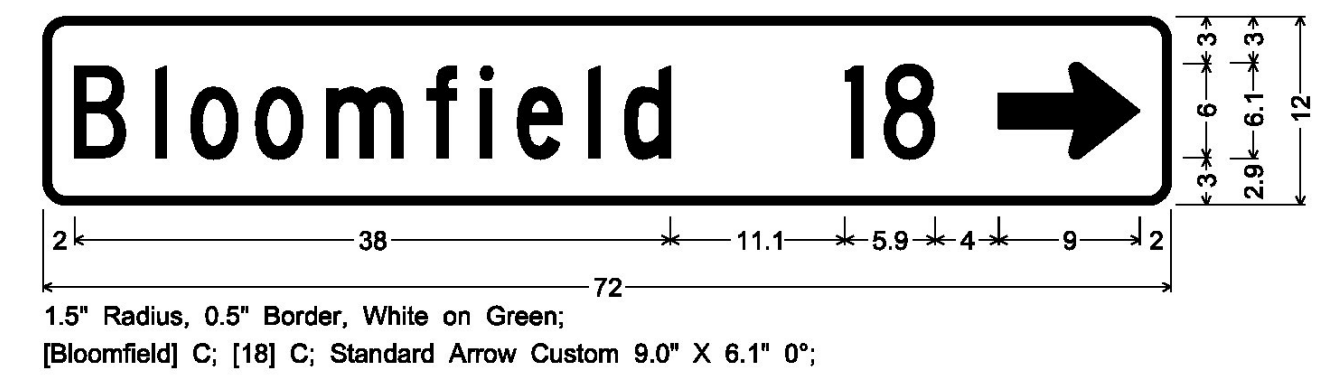
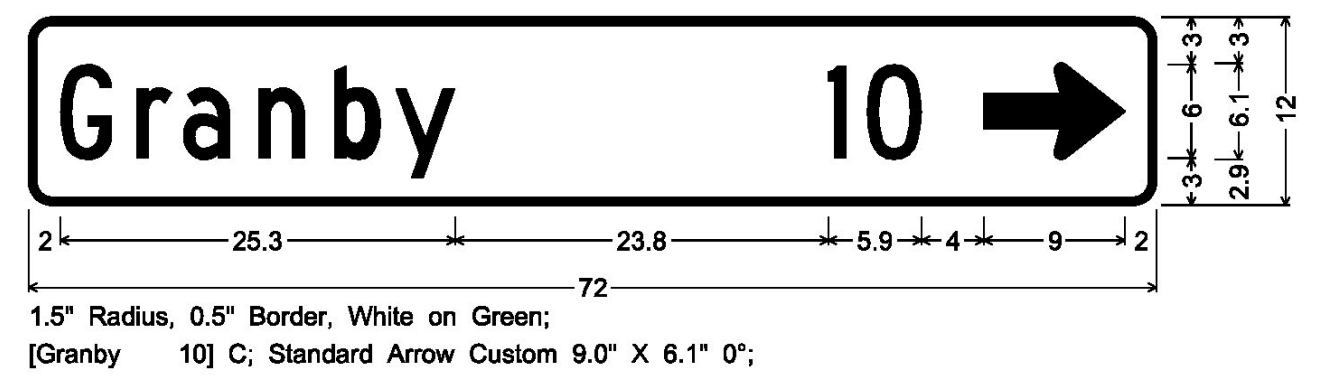
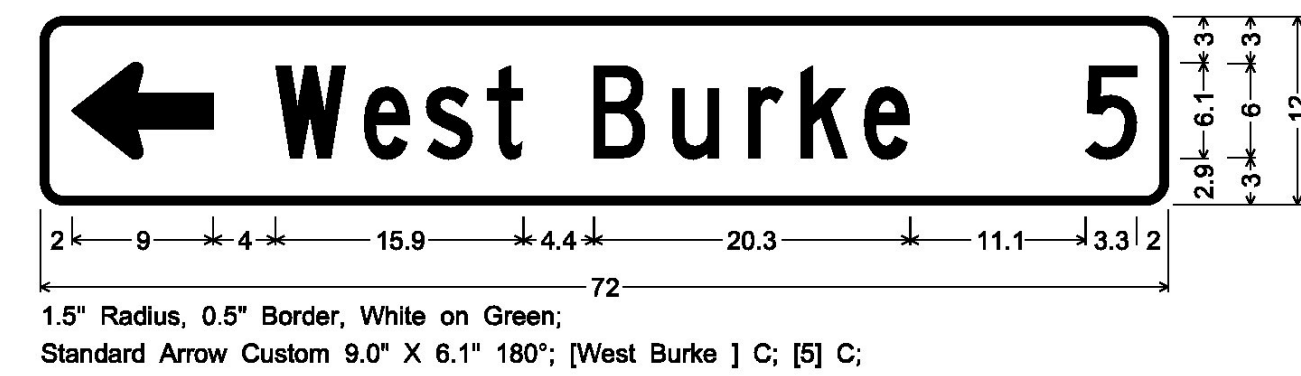
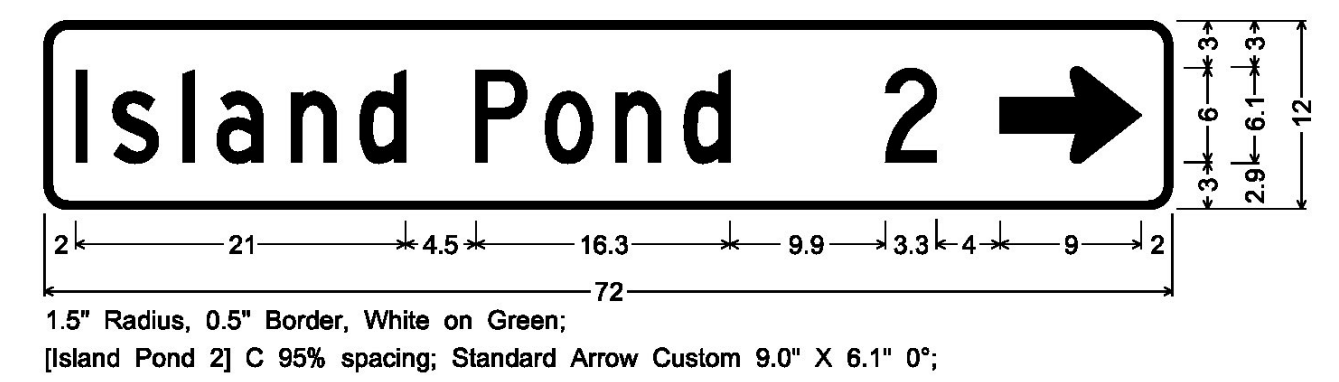
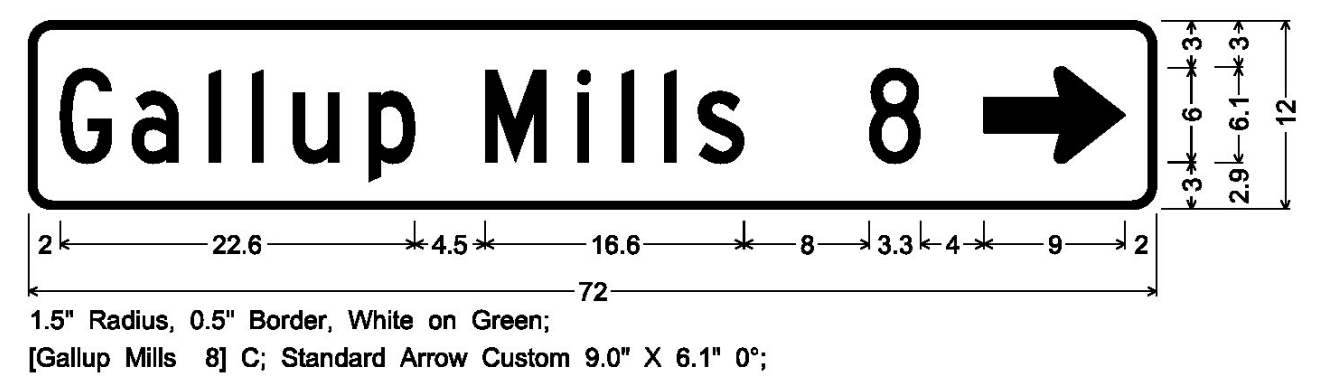
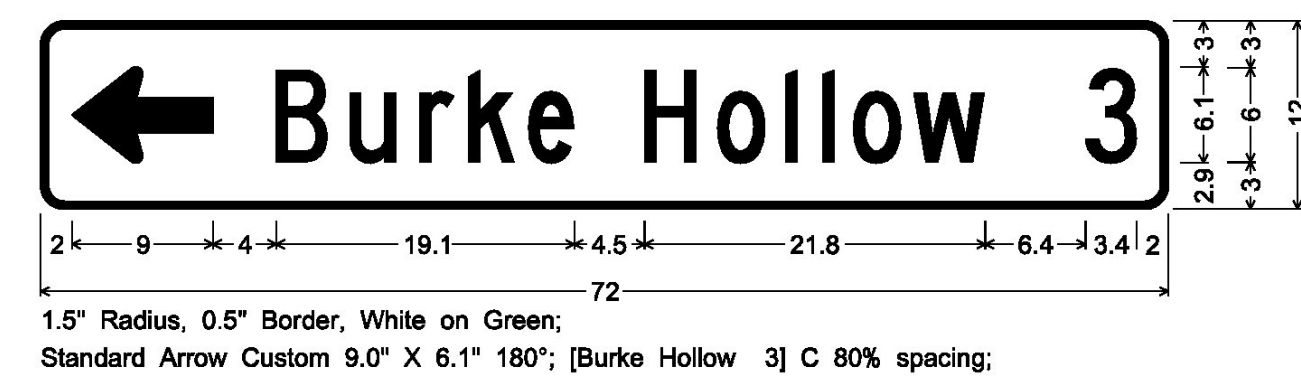
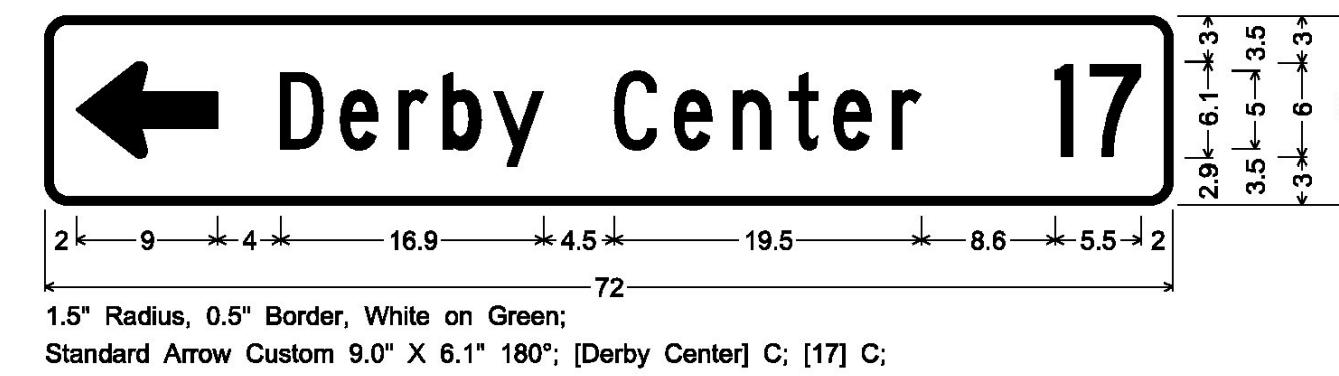
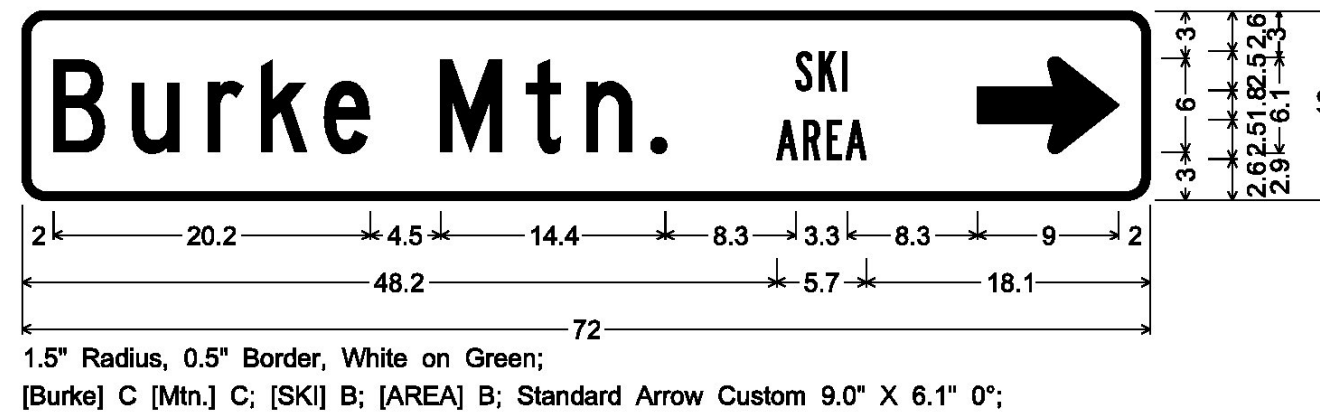
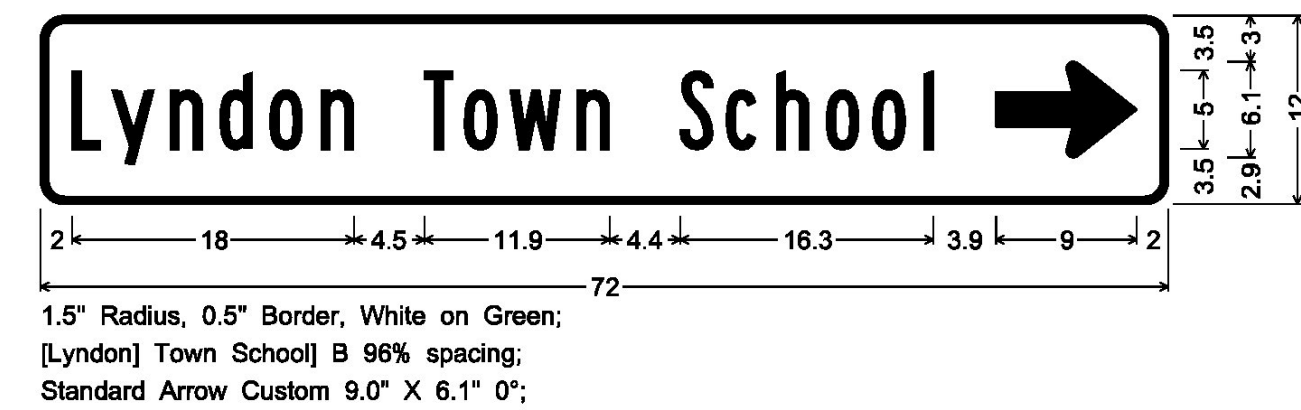

STANDARD SHSM 2.25" ARROW

ALL SIGNS IN THIS SECTION ARE SIGNS CODE VD1-1A

PROJECT NAME:	STATEWIDE-NORTHEAST
PROJECT NUMBER:	STPG SIGN (56)
FILE NAME:	z151007tsss-det.dgn
PROJECT LEADER:	C. LATHROP
DESIGNED BY:	B. BRESLEND
SIGN DETAIL SHEET 6	
PLOT DATE:	5/4/2016
DRAWN BY:	O. DALMER
CHECKED BY:	C. LATHROP
SHEET	11 OF 168