

VT5A

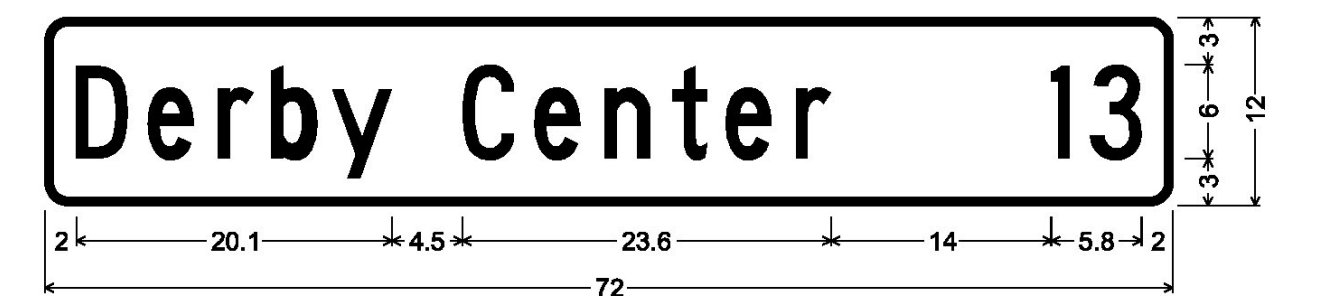
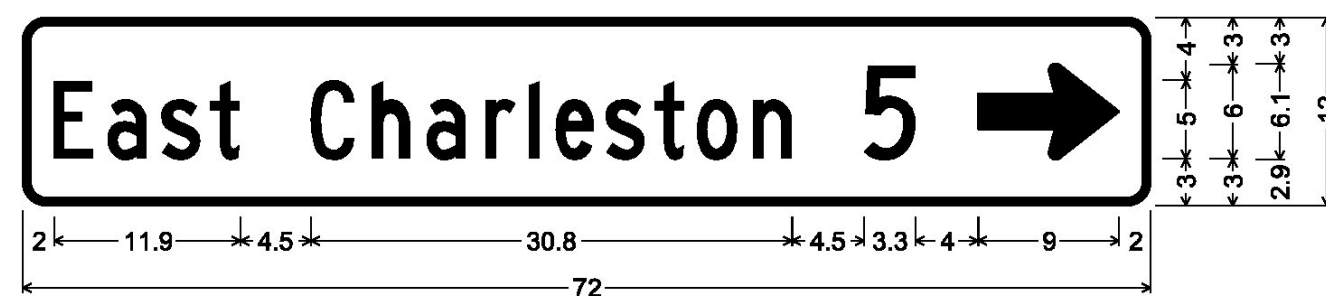
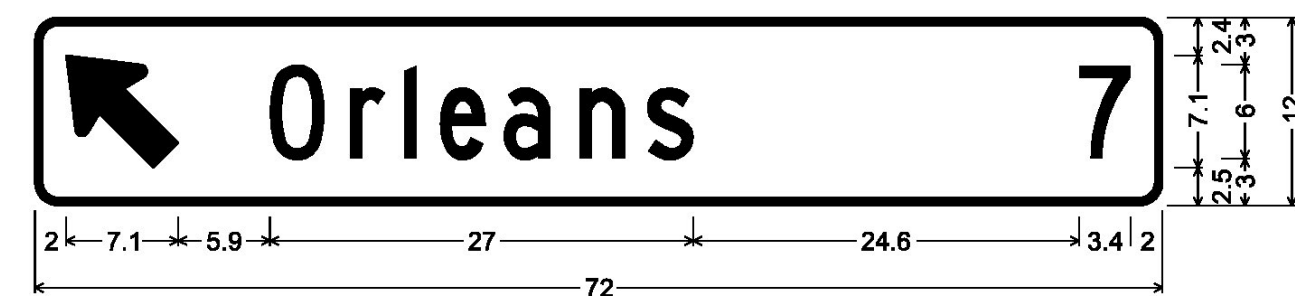
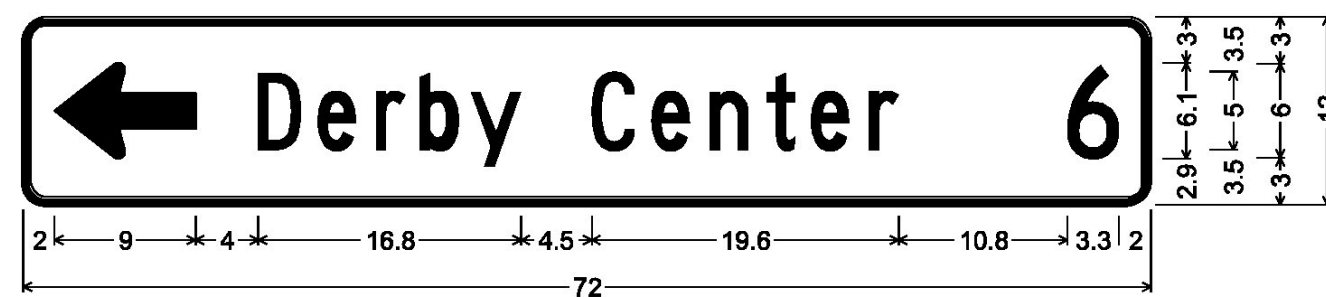
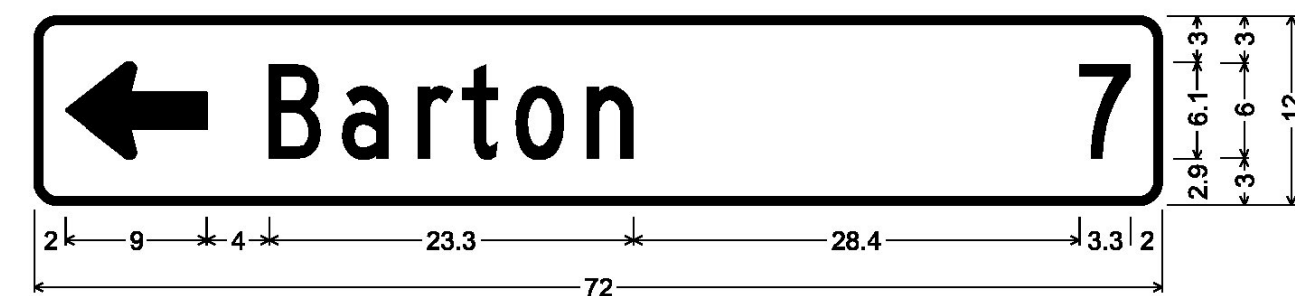
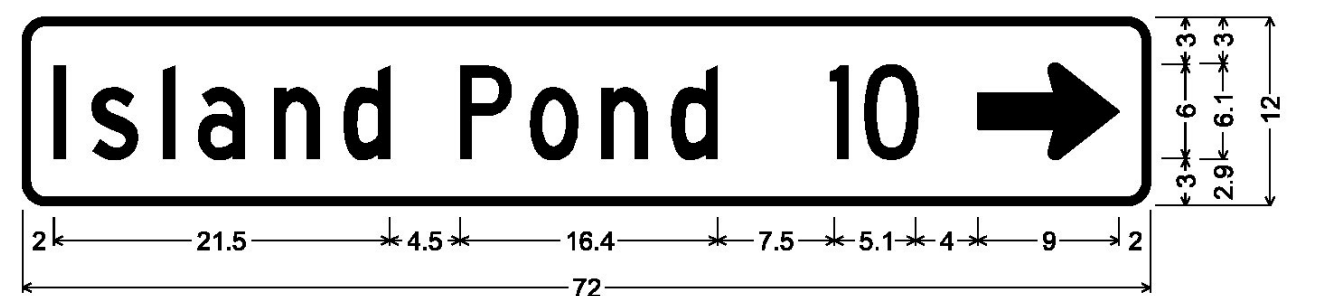
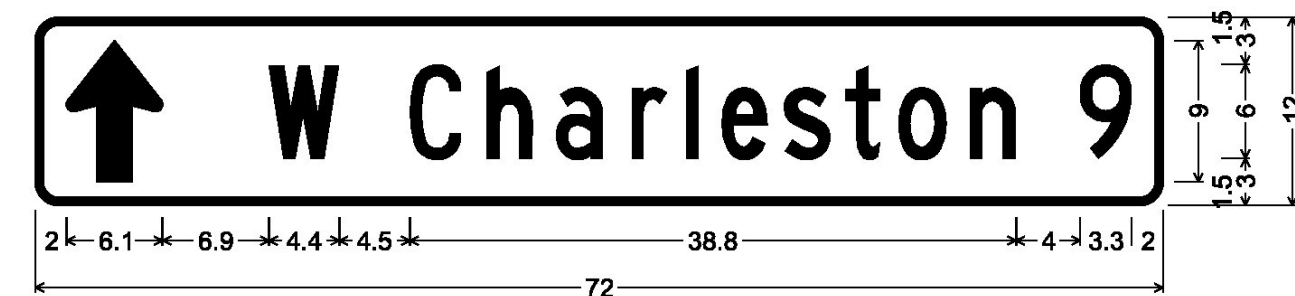
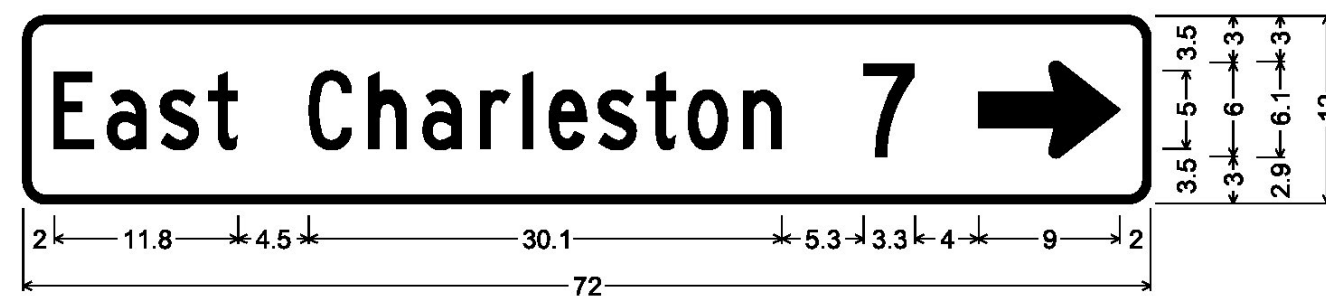
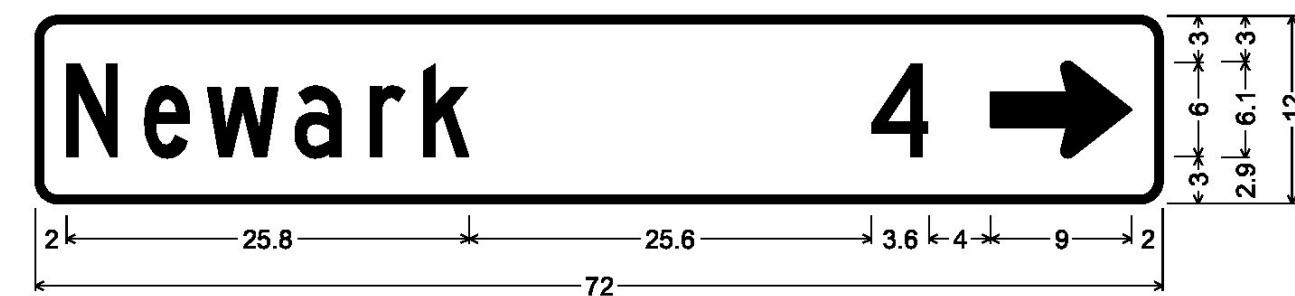
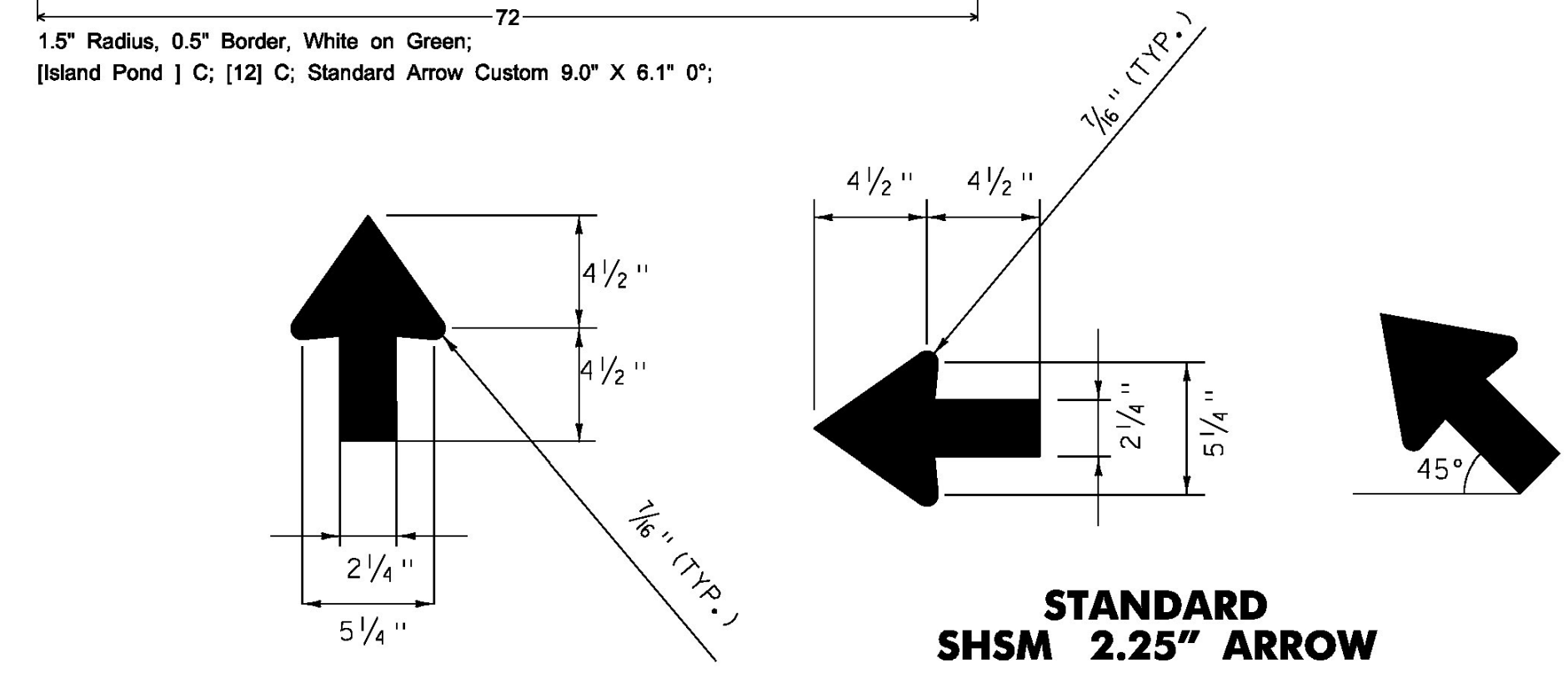
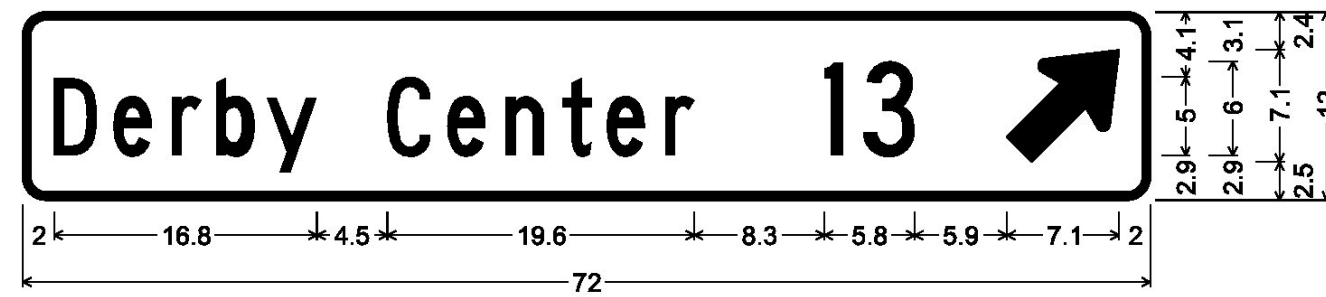
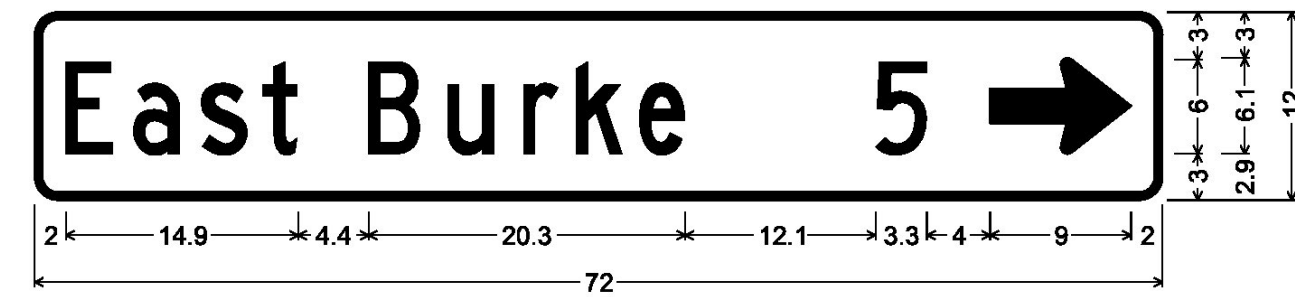
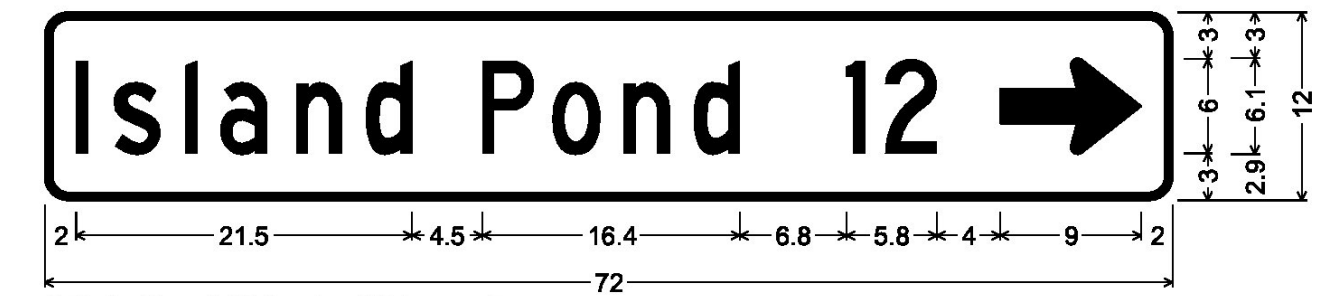
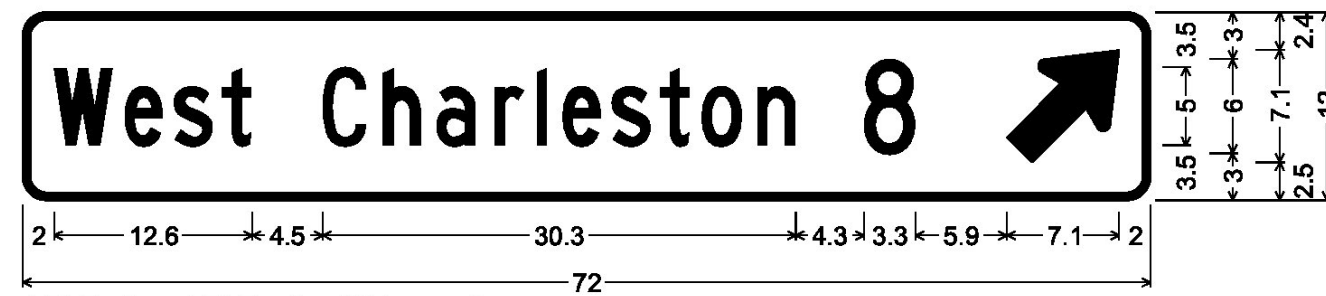
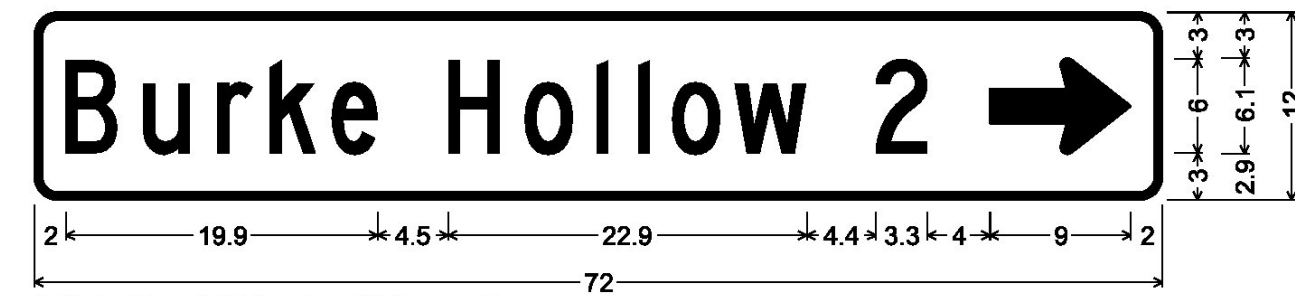

ALL SIGNS IN THIS SECTION ARE SIGNS CODE VDI-1A

ALL SIGNS IN THIS SECTION ARE SIGNS CODE VD2-1

PROJECT NAME:	STATEWIDE-NORTHEAST		
PROJECT NUMBER:	STPG SIGN (56)		
FILE NAME:	z15t007tsss-det.dgn	PLOT DATE:	5/4/2016
PROJECT LEADER:	C. LATHROP	DRAWN BY:	O. DALMER
DESIGNED BY:	B. BRESLEND	CHECKED BY:	C. LATHROP
SIGN DETAIL SHEET 3		SHEET 8	OF 168