

**NOTES**

1. A STRIKE OFF FLUSH FILL TECHNIQUE SHALL BE USED FOR MATERIAL APPLICATION. STRIKE OFF MAY BE ACCOMPLISHED WITH A SHOE.
2. LIMITS OF WORK SHOWN ON PLANS, BEGIN AND END M.M., MAY BE ADJUSTED AS DIRECTED BY THE ENGINEER TO ACCOUNT FOR CONDITIONS IN THE FIELD.
3. RELATIVE HUMIDITY SHOULD BE LESS THAN 80 PERCENT FOR APPLICATION OF THE CRACK SEALANT MATERIAL.
4. BACKFLUSHING OF HOSE AND APPLICATOR WAND IS NECESSARY ANY TIME THE APPLICATION OF SEALANT HAS BEEN DELAYED FOR A PERIOD GREATER THAN 15 MINUTES.
5. THE DISTANCE BETWEEN APPLICATOR AND SQUEEGEE SHOULD BE LESS THAN 3 FEET, BUT IN NO CASE SHOULD IT BE GREATER THAN 6 FEET.
6. THE TIME DELAY BETWEEN THE HOT AIR LANCE TREATMENT AND THE APPLICATION OF THE SEALANT SHOULD BE LESS THAN 2 MINUTES, BUT IN NO CASE GREATER THAN 5 MINUTES.
7. THE ACCEPTABLE SEALANT THICKNESS SHALL BE IN THE RANGE OF + 1/16" ABOVE SURFACE TO - 1/16" BELOW SURFACE. THICKNESSES ABOVE THE SURFACE GREATER THAN 1/16" AND RECESSES GREATER THAN 1/16" BELOW THE SURFACE SHALL REFER TO SECTION 417 - BITUMINOUS CRACK SEALING, SUBSECTION 417.06 PLACING OF SEALER, OF THE STANDARD SPECIFICATIONS.
8. THE MANUFACTURER'S RECOMMENDATIONS ON CURING OF MATERIAL SHALL BE SUPPLIED IN ADVANCE OF ACTIVITIES. THE CURE TIMES MAY BE SHORTENED OR EXTENDED TO MEET CONDITIONS IN THE FIELD AS DIRECTED BY THE ENGINEER.

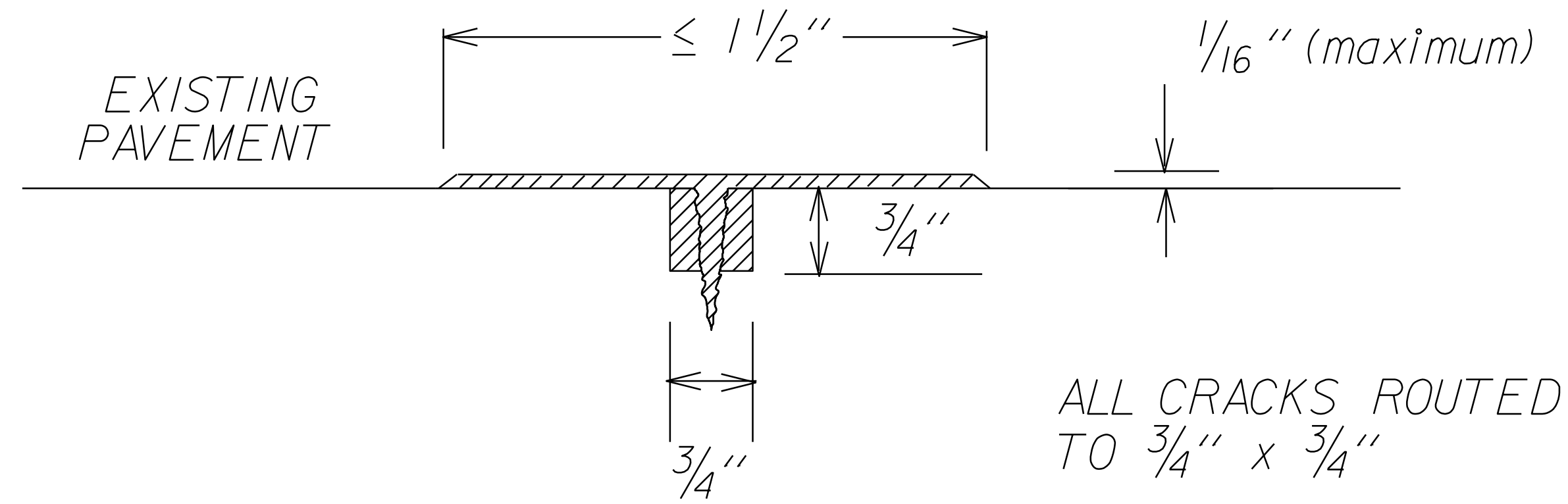

MAXIMUM FILL DEPTH

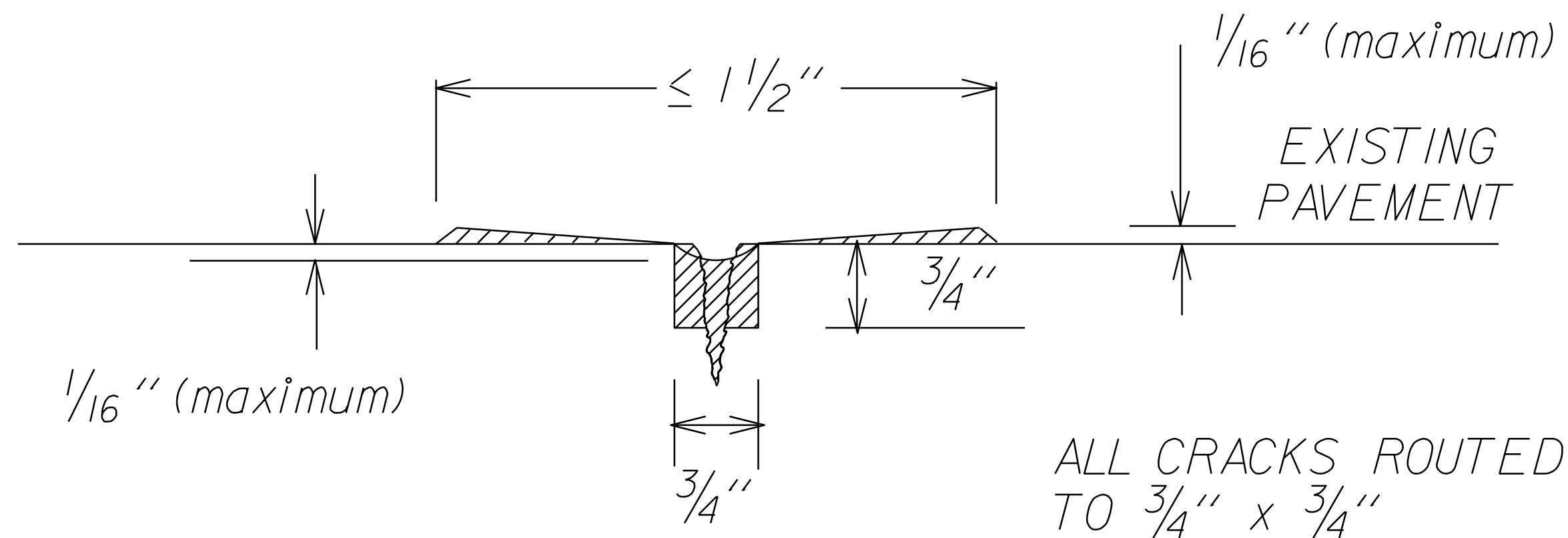

MINIMUM FILL DEPTH

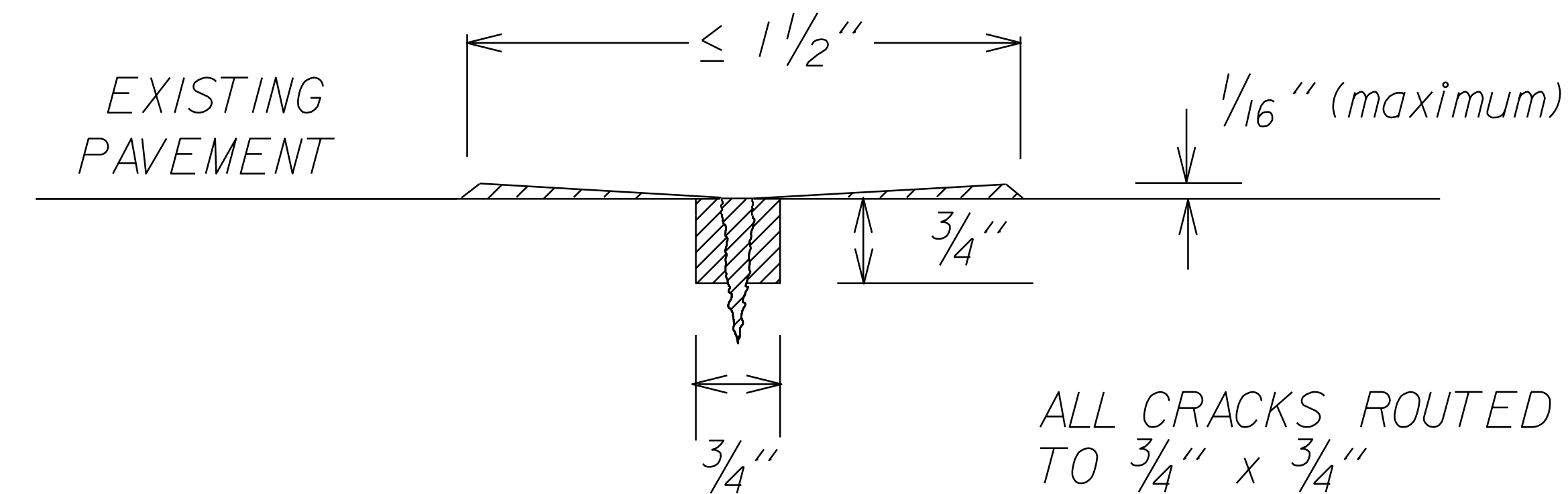

TARGET FLUSH FILL

**NOT TO SCALE**

<b>CRACK SEALING TYPICAL</b>	PROJECT NAME: STATEWIDE	
	PROJECT NUMBER: STP CRAK(31)	
	FILE NAME: pl2k558.dgn	PLOT DATE: 28-FEB-2014 16:17
	PROJECT LEADER: FOWLER	DRAWN BY: LOCKE
	DESIGNED BY: LOCKE	CHECKED BY: HARRINGTON
	pl2k558+yp.i	SHEET 2 OF 14