

FRAME TYPE	A	B
1A	26 1/2	12 1/2
1B	29 1/2	15 1/2
1C	32 1/2	15 1/2

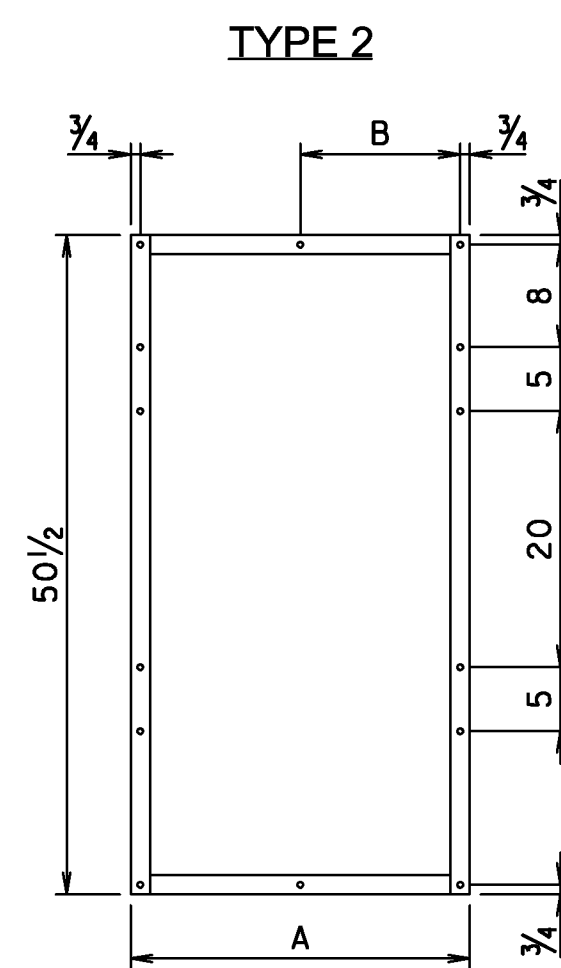

FRAME TYPE	A	B
2A	26 1/2	12 1/2
2B	29 1/2	15 1/2
2C	32 1/2	15 1/2

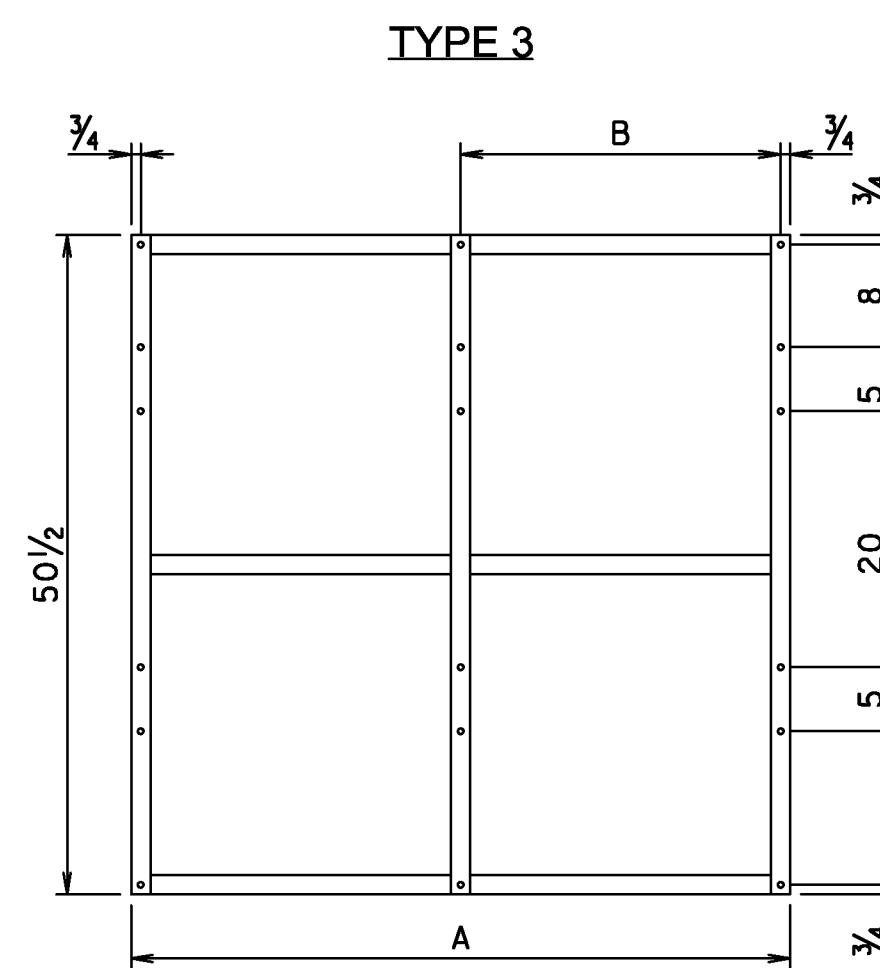

FRAME TYPE	A	B
3A	51 1/2	25
3B	54 1/2	28
3C	57 1/2	28
3D	63 1/2	31

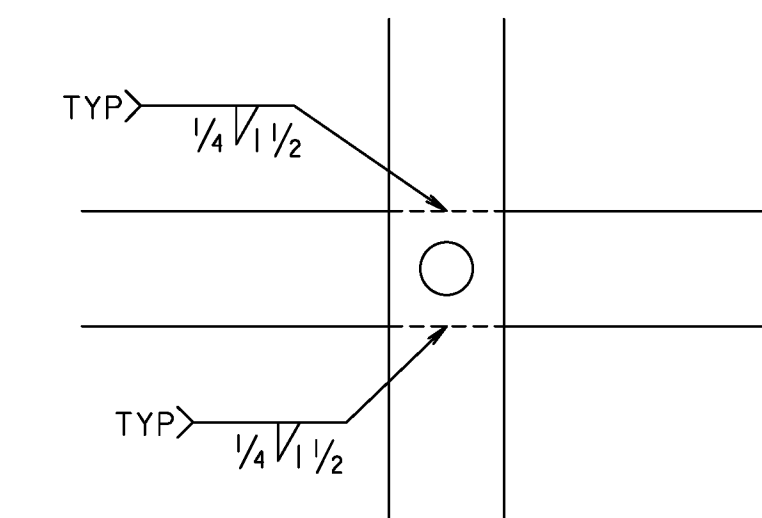
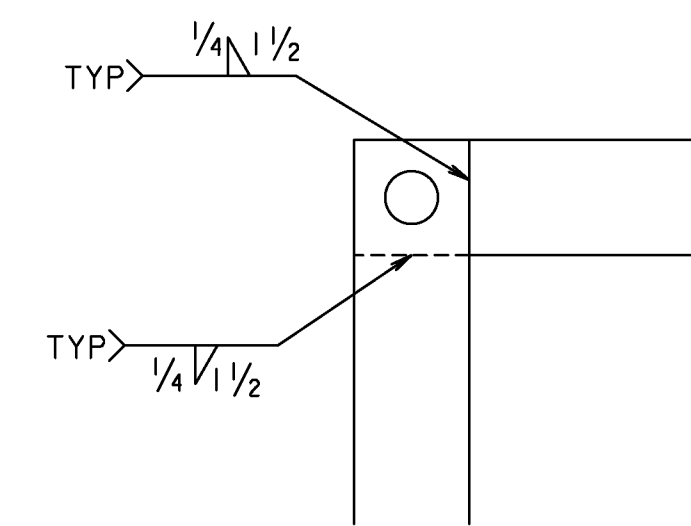

WELDING DETAILS

GENERAL NOTES:

- TYPE 1A FRAME ASSEMBLY TO BE USED WITH TWO 24 INCH WIDE SIGN COLUMNS.
- TYPE 1B FRAME ASSEMBLY TO BE USED WITH ONE 24 INCH WIDE SIGN COLUMN AND ONE 30 INCH WIDE SIGN COLUMN.
- TYPE 1C FRAME ASSEMBLY TO BE USED WITH TWO 30 INCH WIDE SIGN COLUMNS.
- TYPE 2A FRAME ASSEMBLY TO BE USED WITH TWO 24 INCH WIDE SIGN COLUMNS.
- TYPE 2B FRAME ASSEMBLY TO BE USED WITH ONE 24 INCH COLUMN AND ONE 30 INCH WIDE SIGN COLUMN.
- TYPE 2C FRAME ASSEMBLY TO BE USED WITH TWO 30 INCH WIDE COLUMNS.
- TYPE 3A FRAME ASSEMBLY TO BE USED WITH THREE 24 INCH WIDE SIGN COLUMNS.
- TYPE 3B FRAME ASSEMBLY TO BE USED WITH TWO 24 INCH SIGN COLUMNS AND ONE 30 INCH WIDE SIGN COLUMN, WITH THE 30 INCH SIGN COLUMN IN AN OUTSIDE POSITION.
- TYPE 3C FRAME ASSEMBLY TO BE USED WITH ONE 24 INCH WIDE SIGN COLUMN IN THE CENTER AND TWO 30 INCH SIGN COLUMNS ON THE OUTSIDE OR ONE 30 INCH SIGN COLUMN IN THE CENTER AND TWO 24 INCH COLUMNS ON THE OUTSIDE.
- TYPE 3D FRAME ASSEMBLY TO BE USED WITH THREE 30 INCH WIDE SIGN COLUMNS.
- ALL HOLES SHALL BE 7/16 INCH DIAMETER.
- FOR SIGN COMBINATIONS OTHER THAN ABOVE, THE FRAME DIMENSIONS AND HOLE SPACING SHALL BE MODIFIED AS NECESSARY.
- STANDARD FRAMES SHALL BE CONSTRUCTED OF 5/16 INCH X 1 1/2 INCH A-36 STEEL.
- SEE THE MANUAL ON UNIFORM TRAFFIC CONTROL DEVICES (MUTCD) SECTION 2D.29 FOR INSTALLATION SEQUENCE.
- ALL DIMENSIONS SHOWN IN INCHES, UNLESS OTHERWISE NOTED.

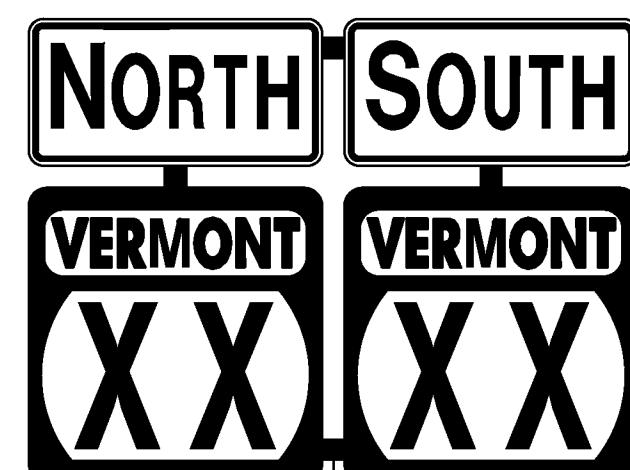

ROUTE MARKER ASSEMBLY TYPE 1

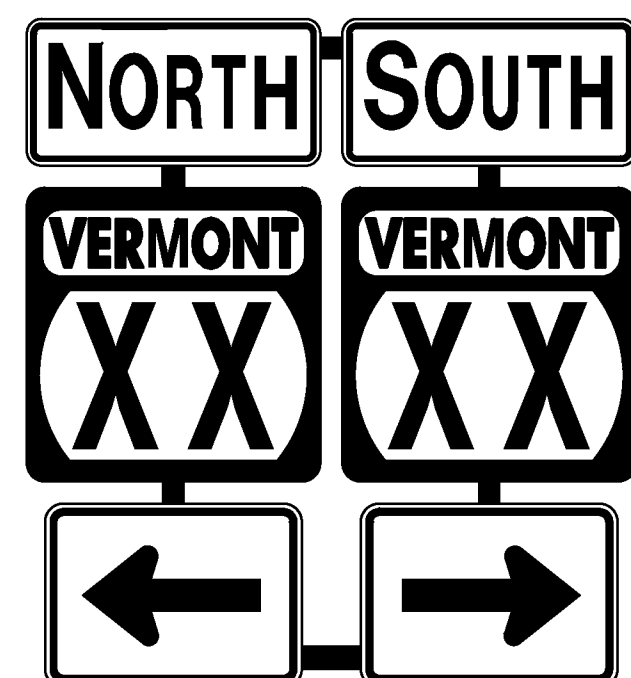

ROUTE MARKER ASSEMBLY TYPE 2

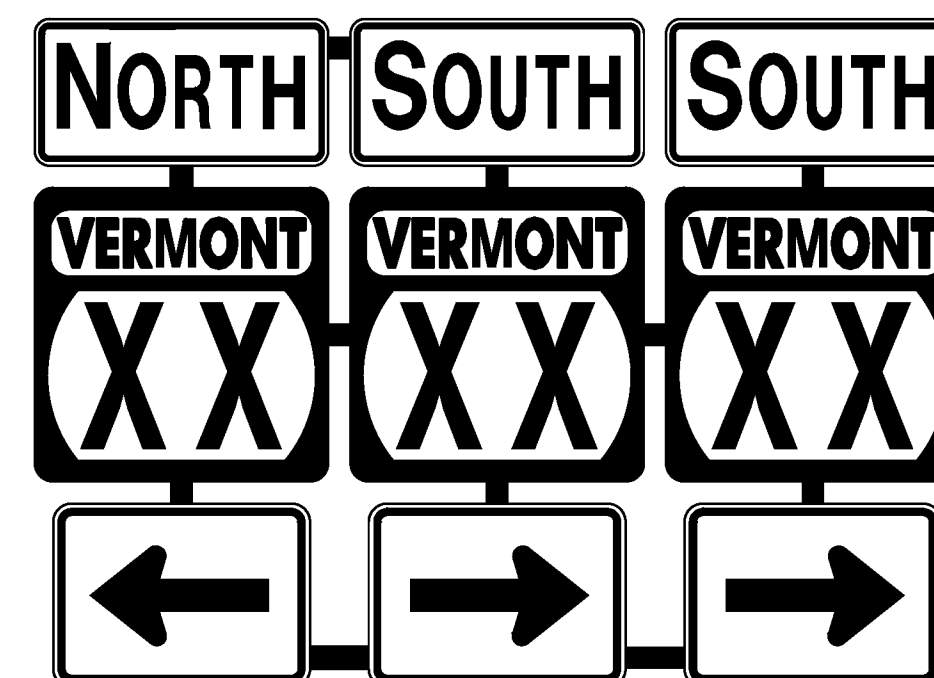

ROUTE MARKER ASSEMBLY TYPE 3

ROUTE MARKER ASSEMBLY FRAMES

ALL DIMENSIONS SHOWN IN INCHES, EXCEPT WHERE NOTED.

NOT TO SCALE

TYLIN INTERNATIONAL

PROJECT NAME: STATEWIDE-SOUTHWEST
PROJECT NUMBER: STPG SIGN(47)

FILE NAME: z12c534_SD01.dgn
PROJECT LEADER: D. BRYANT
DESIGNED BY: B. TOOTHAKER
SIGN DETAILS 2

PLOT DATE: 9/15/2014
DRAWN BY: B. TOOTHAKER
CHECKED BY: K. KERN
SHEET 5 OF 107