

36.00" ACROSS SIDES, 2.25" RADIUS, 0.875" BORDER, 0.625" INDENT, BLACK ON YELLOW; [SHOULDER] 5"C; [NARROWS] 5"C
VW-619

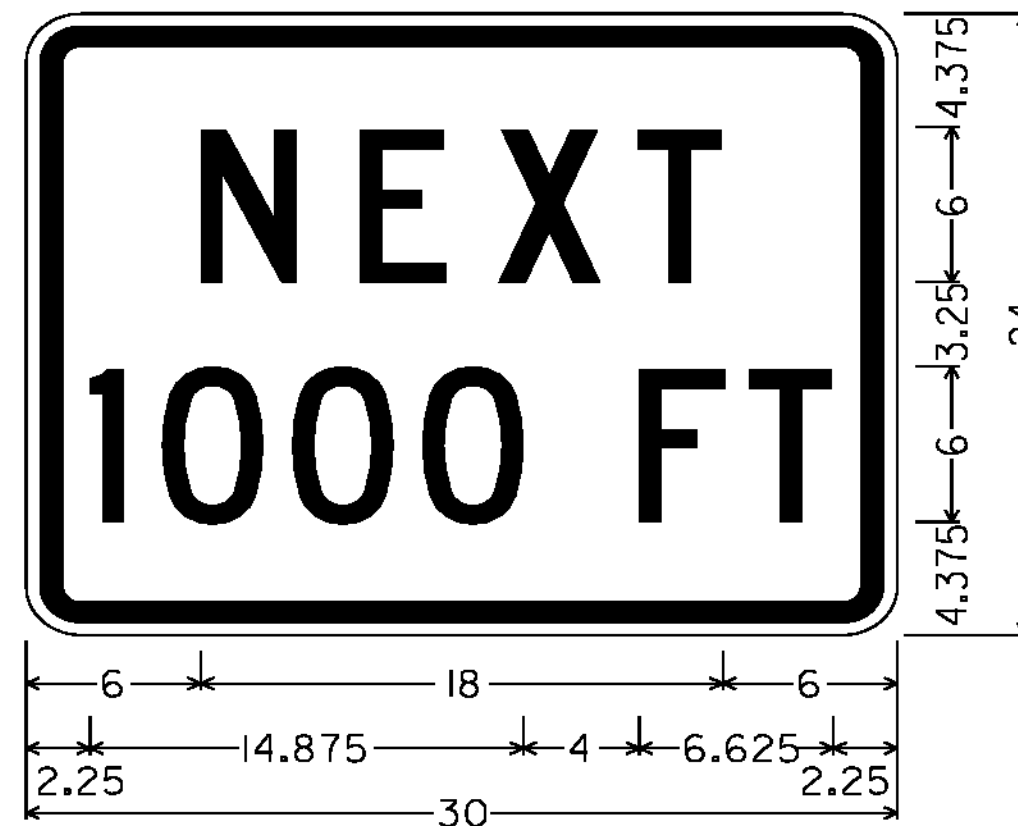

1.875" RADIUS, 0.750" BORDER, 0.500" INDENT, BLACK ON FLUORESCENT YELLOW-GREEN; [NEXT] 6"C; [1000 FT] 6"C
W16-4P

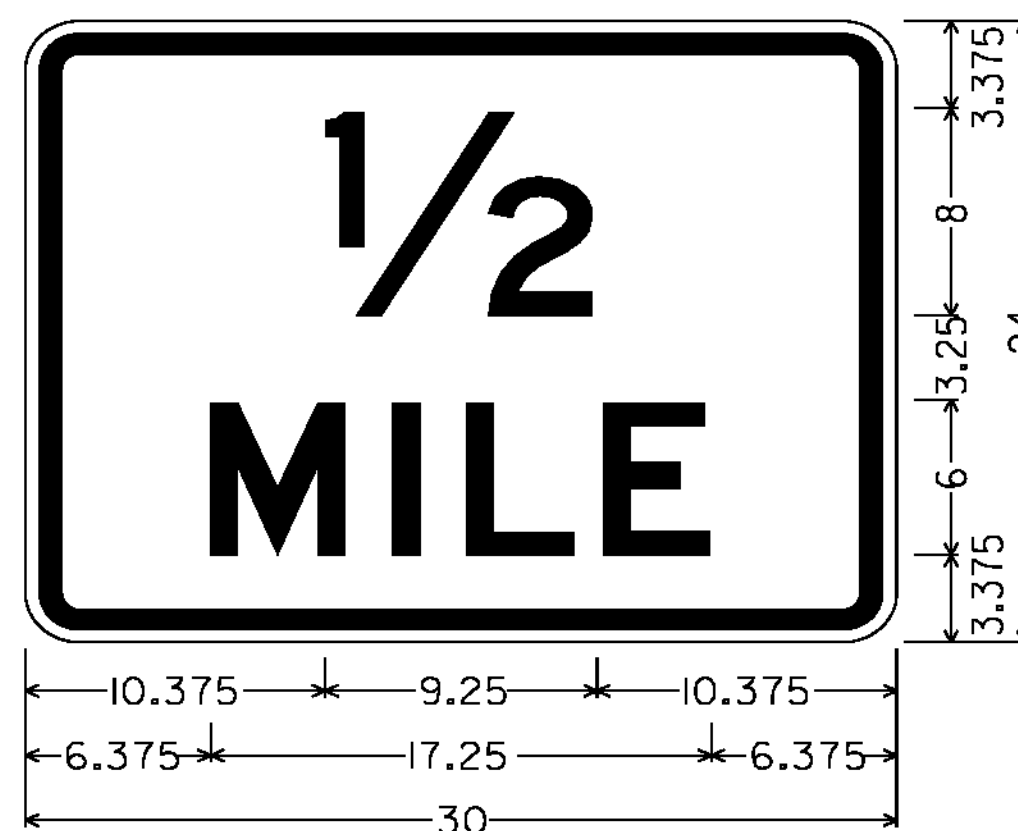

1.875" RADIUS, 0.750" BORDER, 0.500" INDENT, BLACK ON YELLOW; [1/2] 8"D; [MILE] 6"D
W16-3P

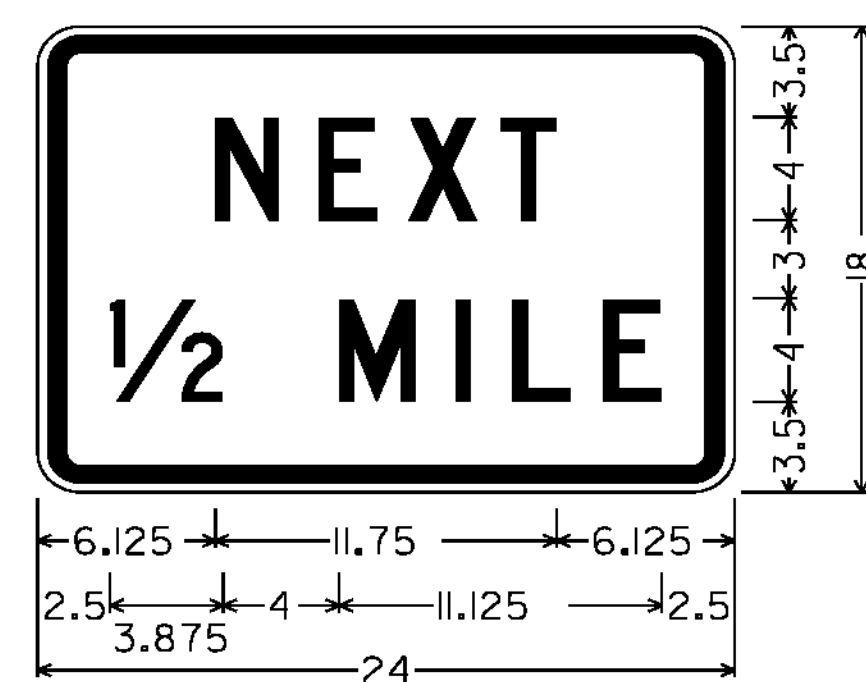

1.500" RADIUS, 0.625" BORDER, 0.375" INDENT, BLACK ON YELLOW; [NEXT] 4"C; [1/2 MILE] 4"C
W7-3aP

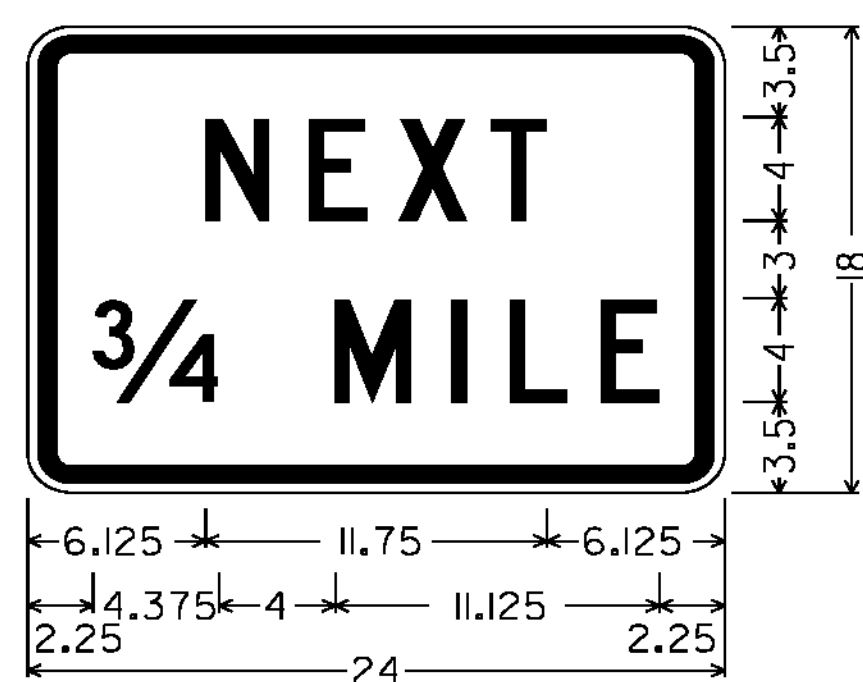

1.500" RADIUS, 0.625" BORDER, 0.375" INDENT, BLACK ON YELLOW; [NEXT] 4"C; [3/4 MILE] 4"C
W7-3aP

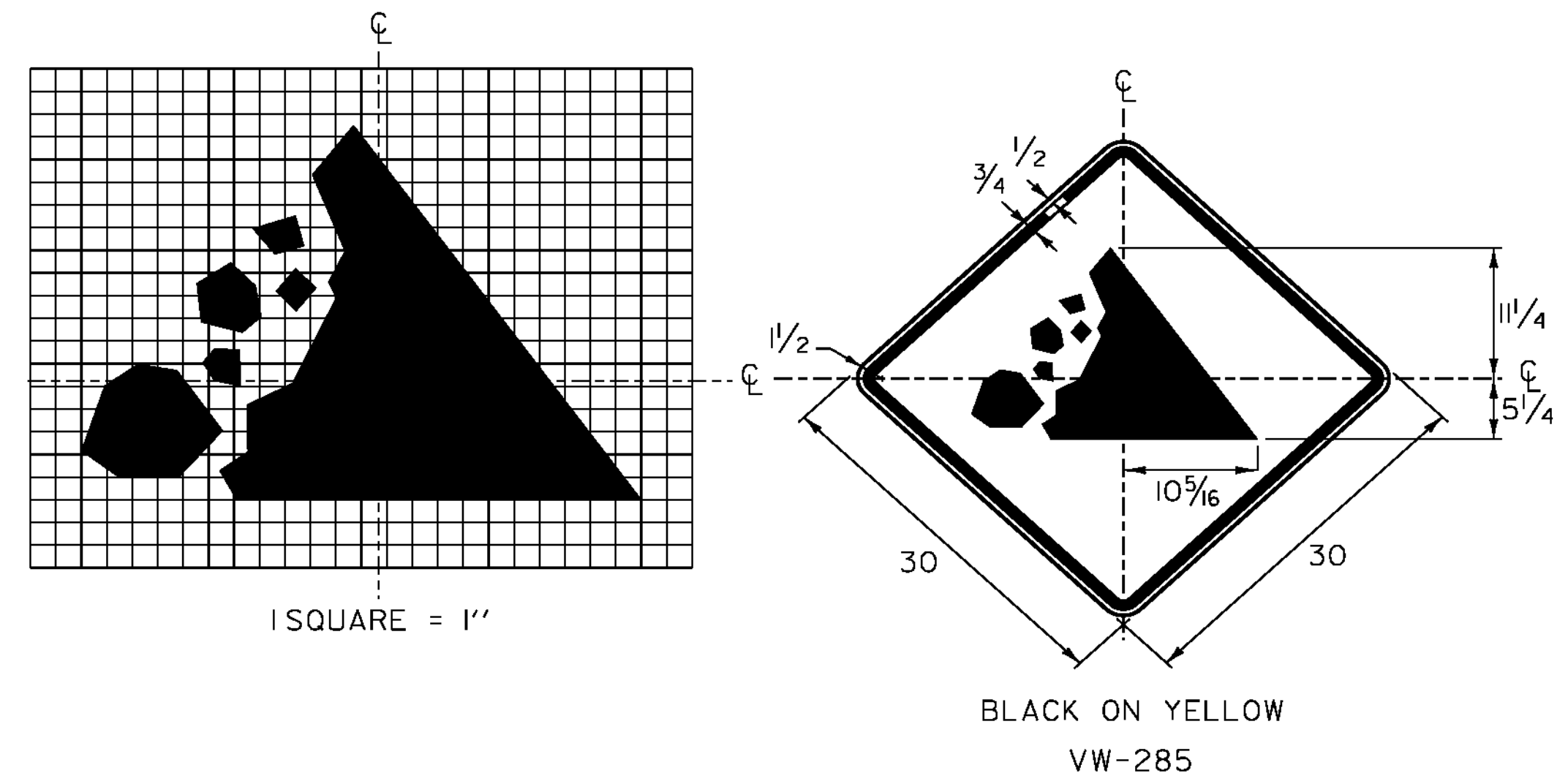

1 SQUARE = 1"

BLACK ON YELLOW
VW-285

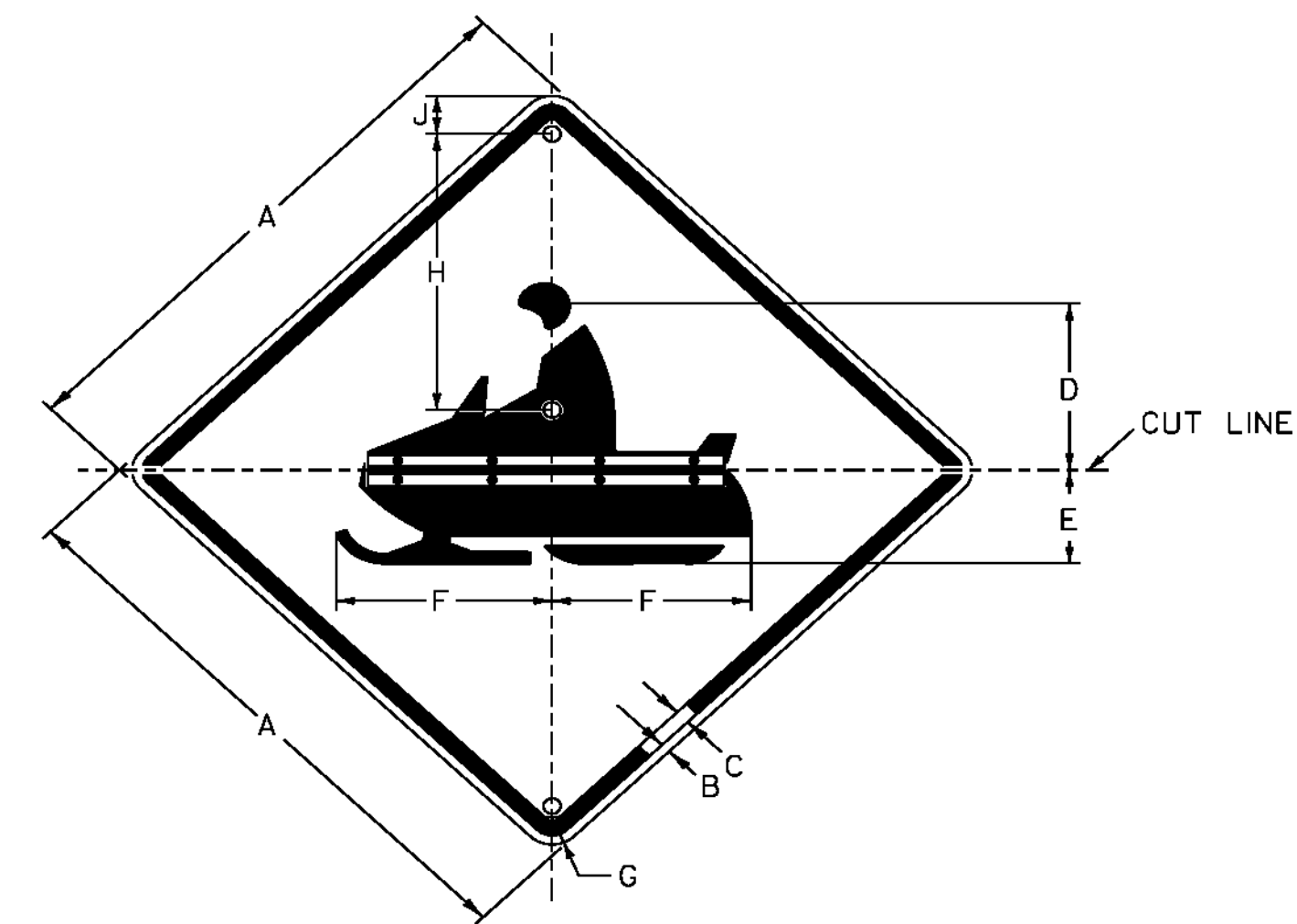

BLACK ON YELLOW
W11-6H

SIGN	DIMENSIONS (INCHES)									
	A	B	C	D	E	F	G	H	J	
STD.	30	1/2	3/4	11/16	5/8	12 1/16	1 7/8	1 1/4	2 1/2	

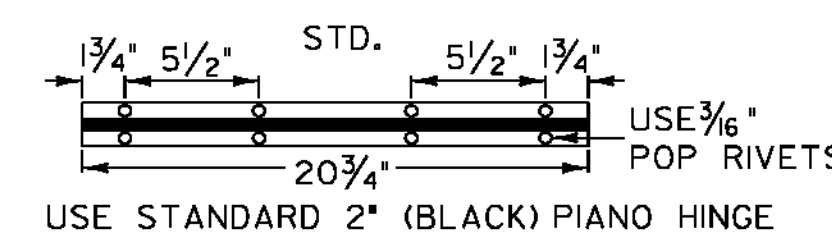

ALL DIMENSIONS SHOWN IN INCHES, EXCEPT WHERE NOTED.

PROJECT NAME: SPRINGFIELD - HARTFORD
PROJECT NUMBER: STPG SIGN (33)

FILE NAME: IOC332.SD_5
PROJECT LEADER: A. GAMBLE
DESIGNED BY: M. MILLER
SIGN DETAILS 5

PLOT DATE: 21-FEB-2012
DRAWN BY: M. MILLER
CHECKED BY: A. GAMBLE
SHEET 8 OF 162

NOT TO SCALE