

NORTHFIELD SIGNS CONTINUED

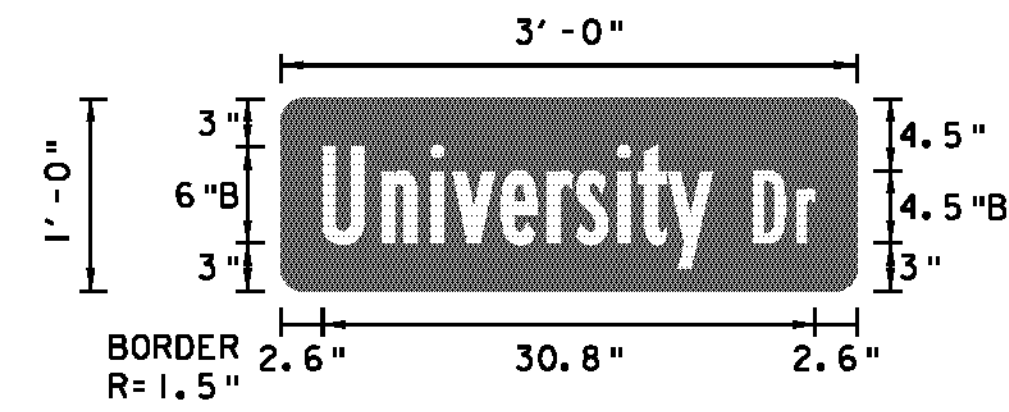

Panel Style: Street Name 6-4in no border.ssi
M.U.T.C.D.: 2009 Edition

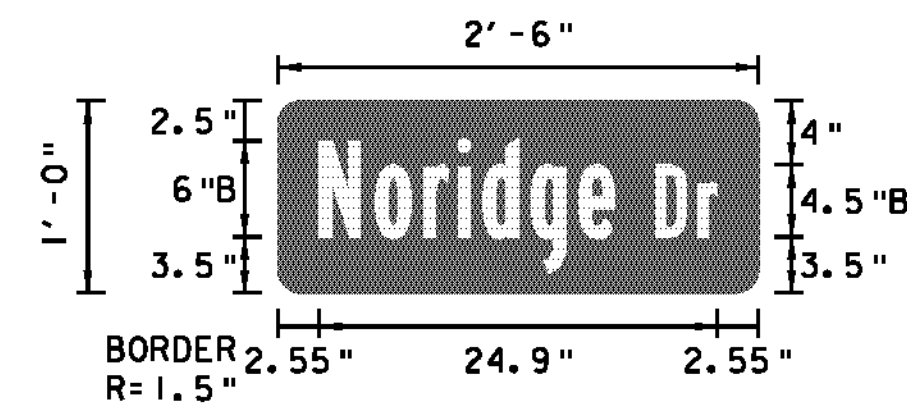

Panel Style: Street Name 6-4in no border.ssi
M.U.T.C.D.: 2009 Edition

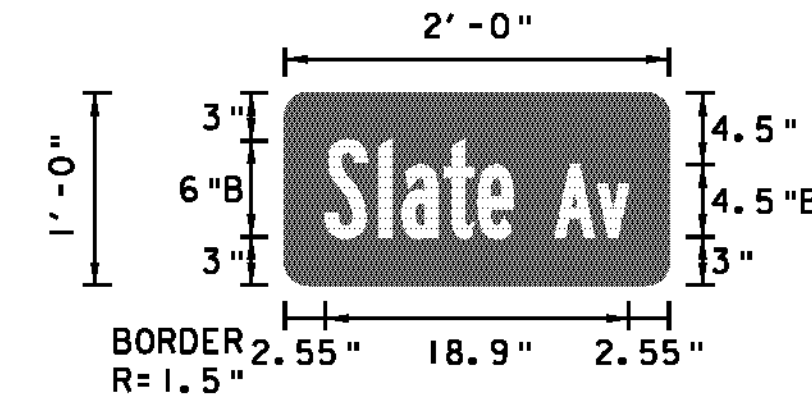

Panel Style: Street Name 6-4in no border.ssi
M.U.T.C.D.: 2009 Edition

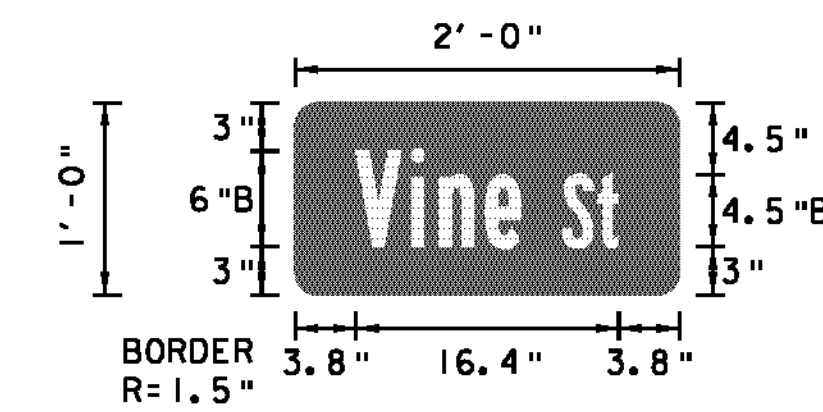

Panel Style: Street Name 6-4in no border.ssi
M.U.T.C.D.: 2009 Edition

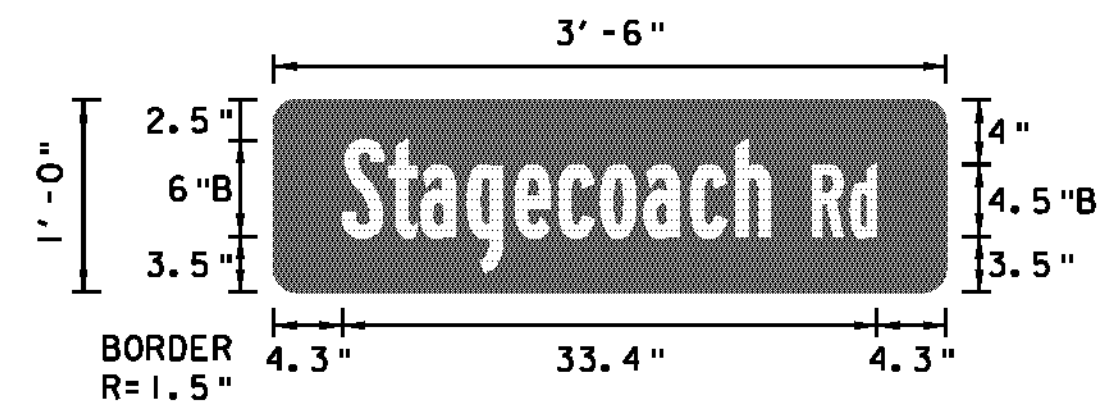

Panel Style: Street Name 6-4in no border.ssi
M.U.T.C.D.: 2009 Edition

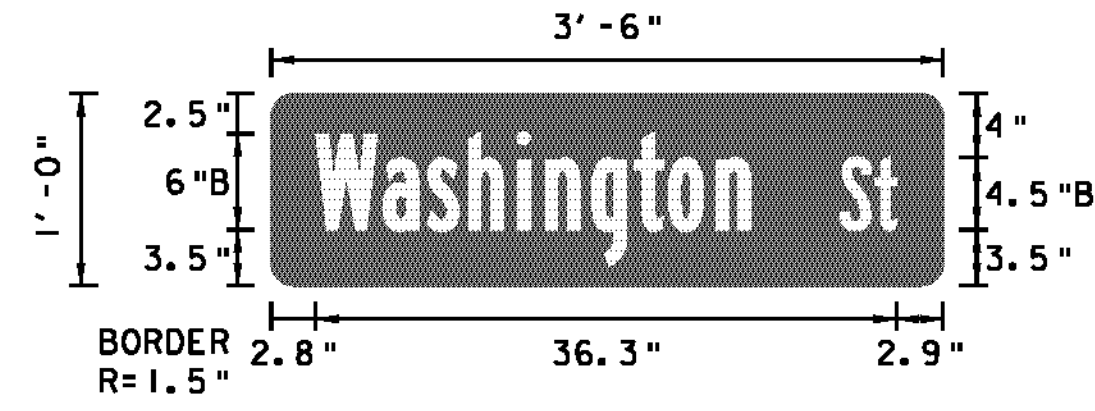

Panel Style: Street Name 6-4in no border.ssi
M.U.T.C.D.: 2009 Edition

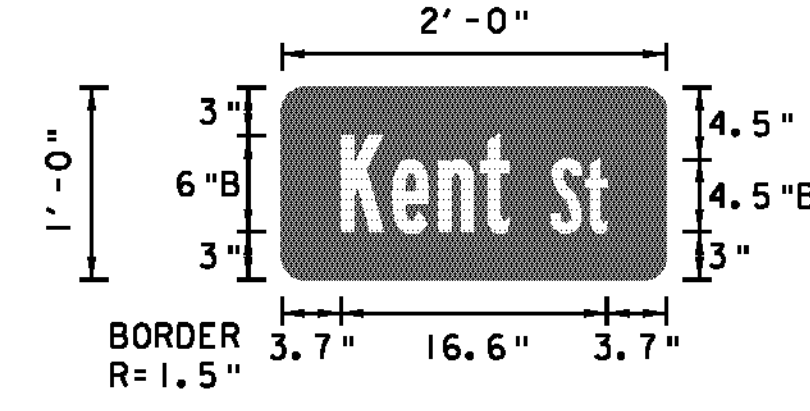

Panel Style: Street Name 6-4in no border.ssi
M.U.T.C.D.: 2009 Edition

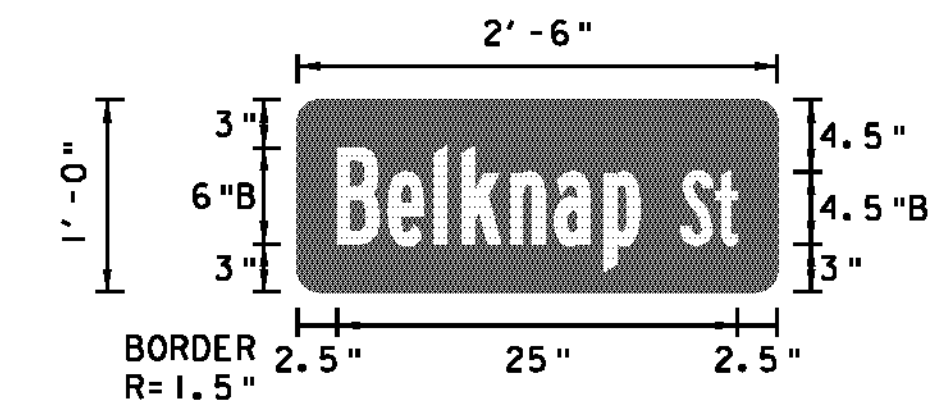

Panel Style: Street Name 6-4in no border.ssi
M.U.T.C.D.: 2009 Edition

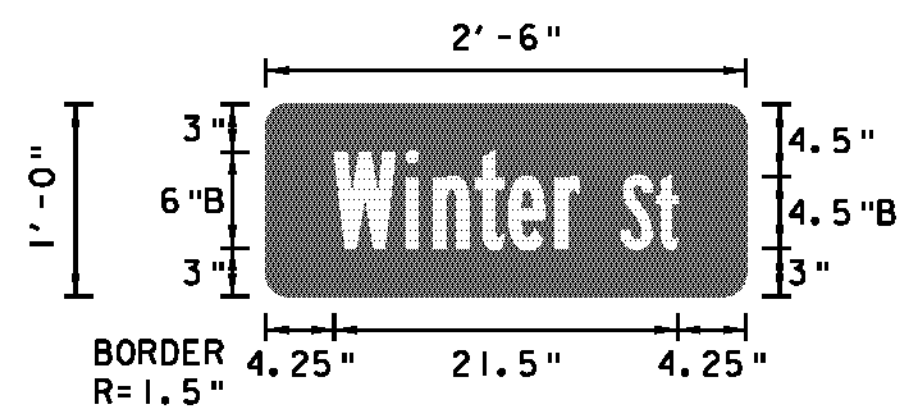

Panel Style: Street Name 6-4in no border.ssi
M.U.T.C.D.: 2009 Edition

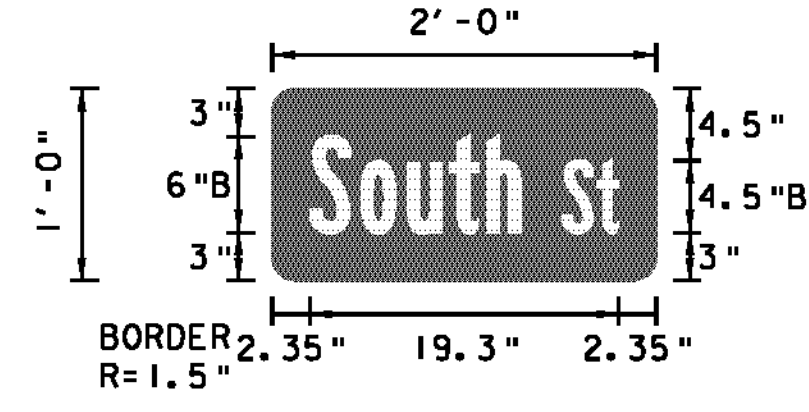

Panel Style: Street Name 6-4in no border.ssi
M.U.T.C.D.: 2009 Edition

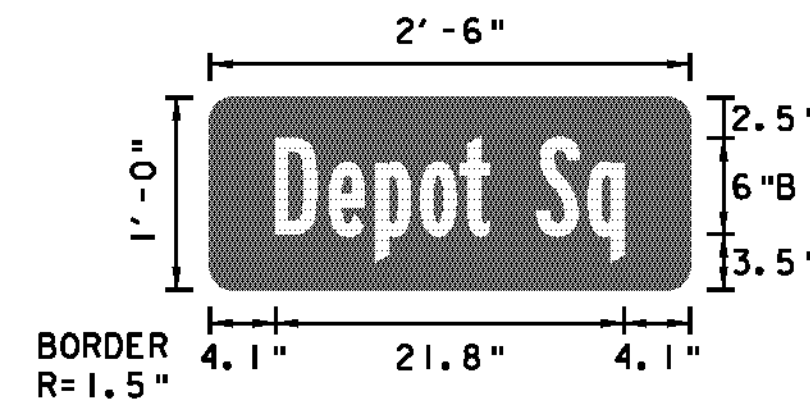

Panel Style: Street Name 6-4in no border.ssi
M.U.T.C.D.: 2009 Edition

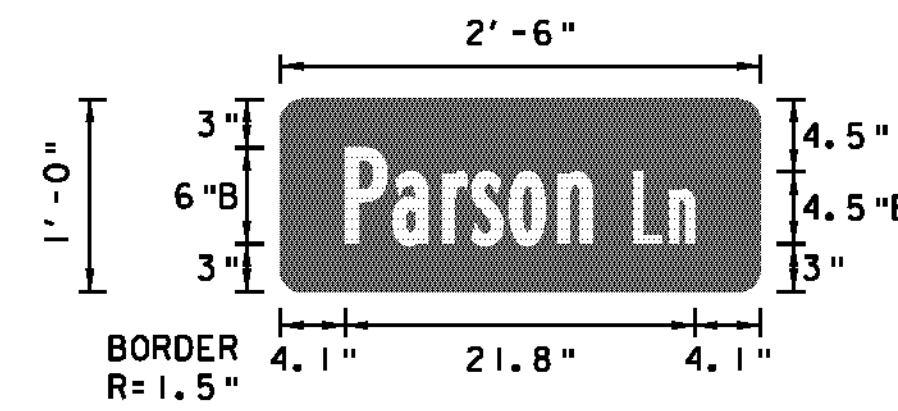

Panel Style: Street Name 6-4in no border.ssi
M.U.T.C.D.: 2009 Edition

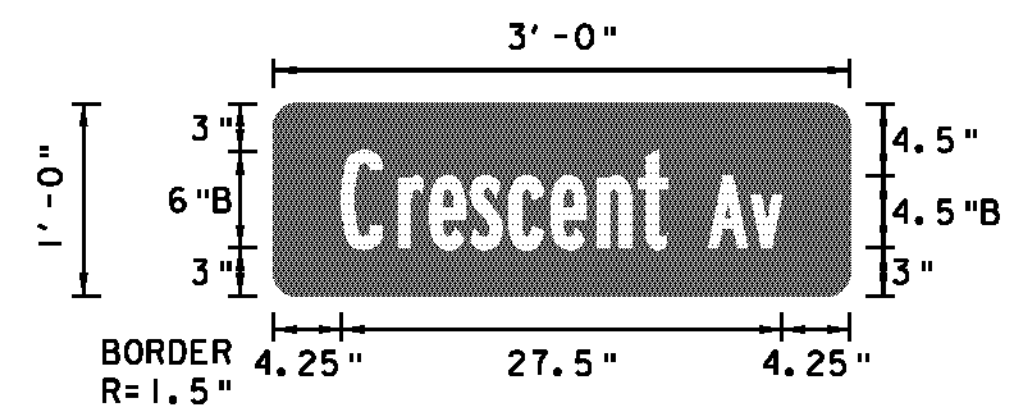

Panel Style: Street Name 6-4in no border.ssi
M.U.T.C.D.: 2009 Edition

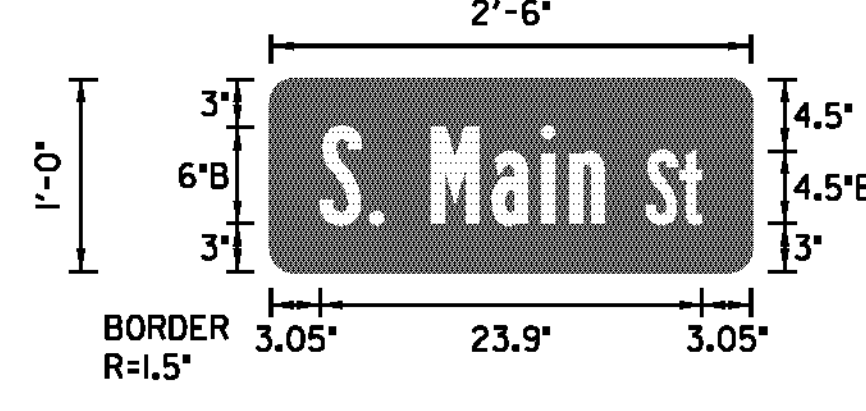

Panel Style: Street Name 6-4in no border.ssi
M.U.T.C.D.: 2009 Edition

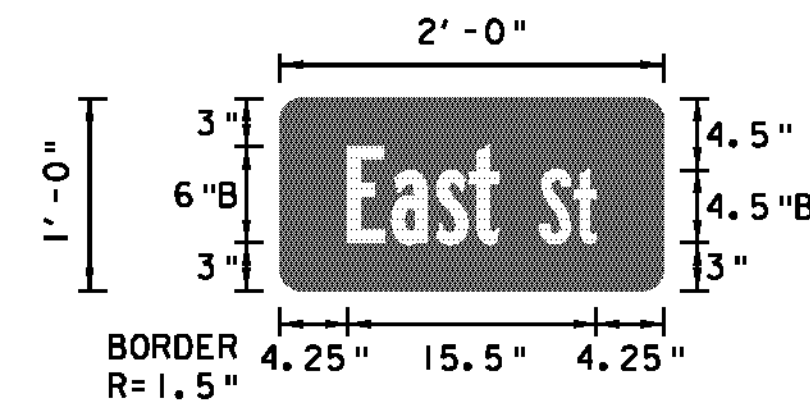

Panel Style: Street Name 6-4in no border.ssi
M.U.T.C.D.: 2009 Edition

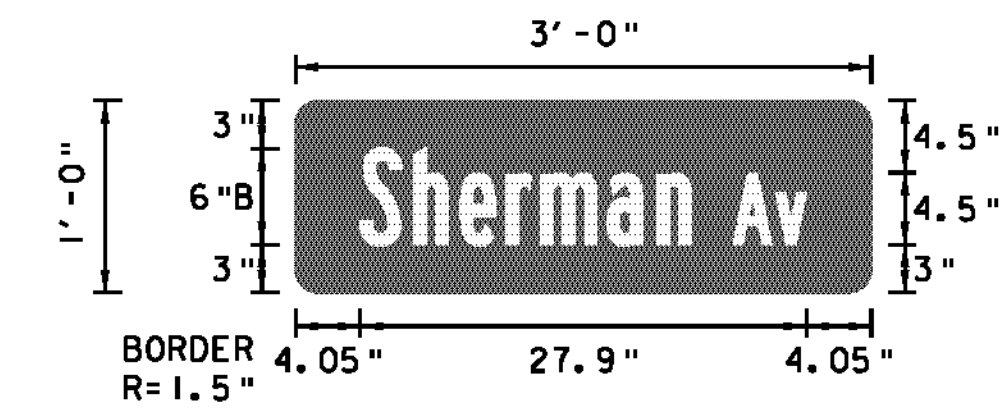

Panel Style: Street Name 6-4in no border.ssi
M.U.T.C.D.: 2009 Edition

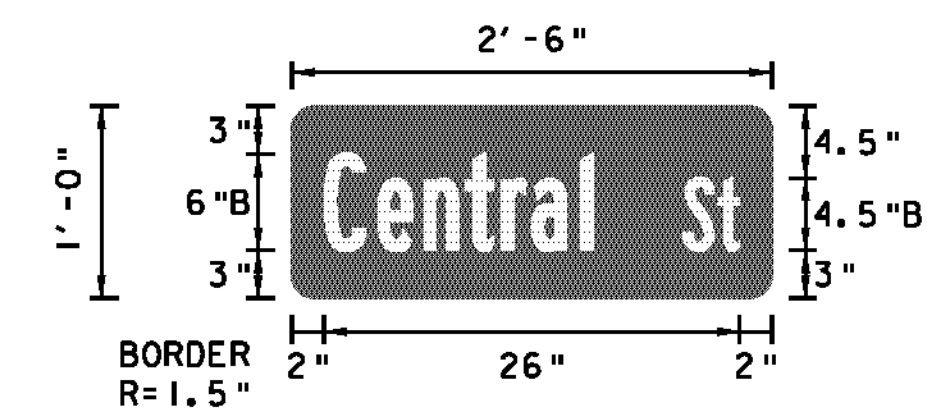

Panel Style: Street Name 6-4in no border.ssi
M.U.T.C.D.: 2009 Edition

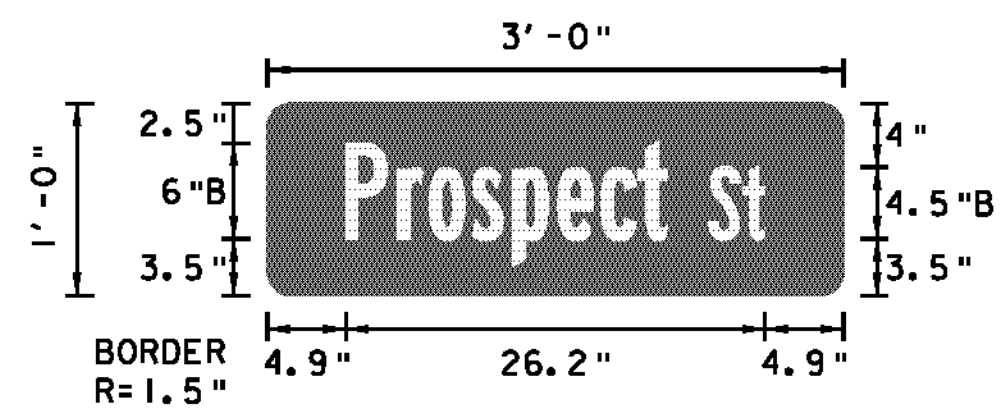

Panel Style: Street Name 6-4in no border.ssi
M.U.T.C.D.: 2009 Edition

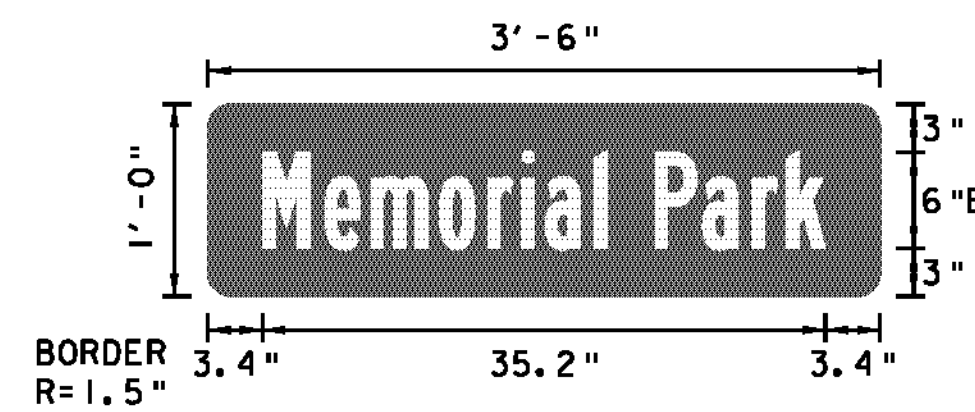

Panel Style: Street Name 6-4in no border.ssi
M.U.T.C.D.: 2009 Edition

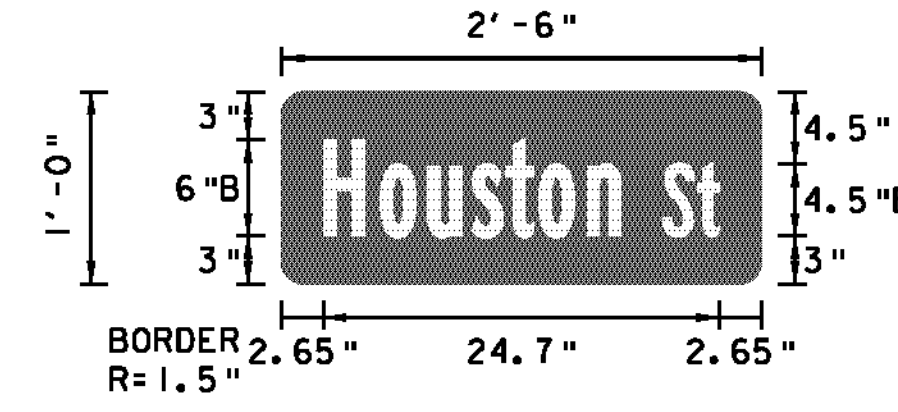

Panel Style: Street Name 6-4in no border.ssi
M.U.T.C.D.: 2009 Edition

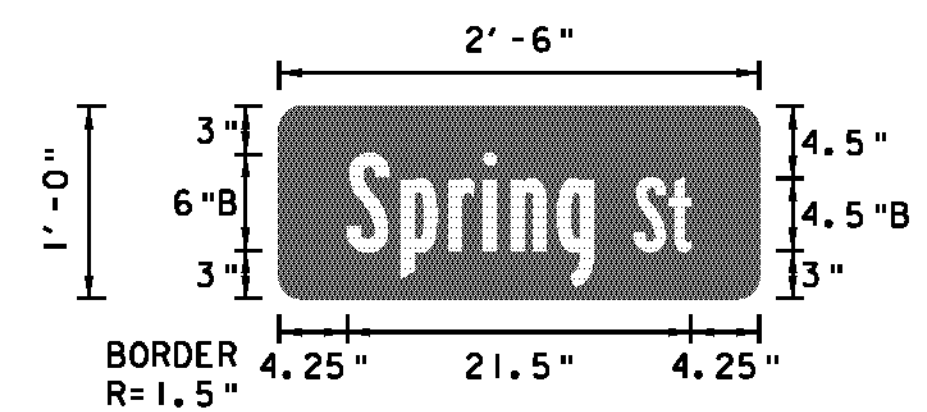

Panel Style: Street Name 6-4in no border.ssi
M.U.T.C.D.: 2009 Edition

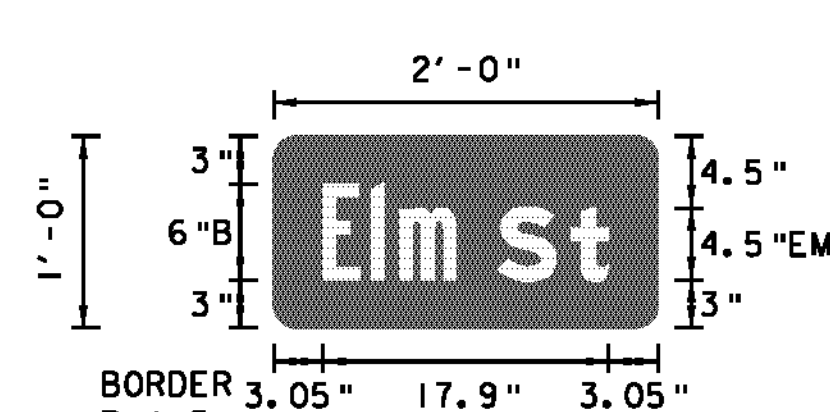

Panel Style: Street Name 6-4in no border.ssi
M.U.T.C.D.: 2009 Edition

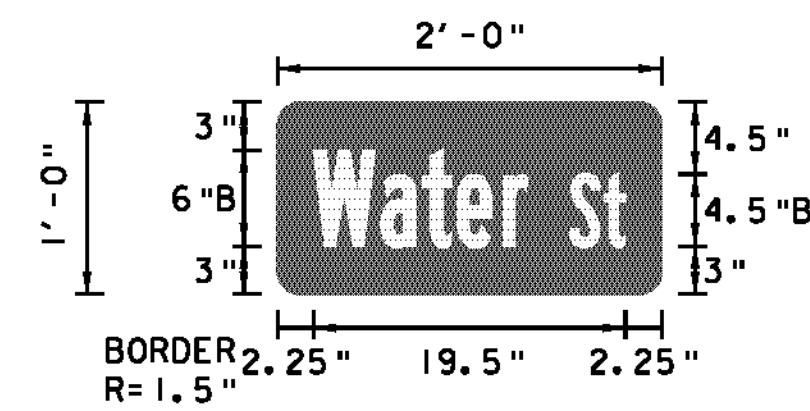

Panel Style: Street Name 6-4in no border.ssi
M.U.T.C.D.: 2009 Edition

**TRAFFIC
SIGN
DETAIL
SHEET 4**

PROJECT NAME: BETHEL - RANDOLPH - NORTHFIELD
PROJECT NUMBER: STP 2922 (I)

FILE NAME: p10C246.dgn
PROJECT LEADER: CDL
DESIGNED BY: SJL
PLOT FILE: p10C246_139.1

PLOT DATE: 1/3/13
DRAWN BY: JBG
CHECKED BY: CDL
SHEET 139 OF 149