

GPS CONTROL POINTS

HVCTRL 16
Standard Disk Stamped

Langde 11
NORTH = 230524.176
EAST = 492970.012
ELEV. = 240.692

TO REACH FROM THE INTERSECTION OF ROUTES 15 AND 100 IN MORRISVILLE GO EAST ALONG ROUTE 15 FOR 0.1 MI (0.2 KM) TO OLD FARM BUILDINGS ON THE LEFT, TURN LEFT INTO FARM YARD AND PARK VEHICLE, WALK NORTHEAST THROUGH BARNYARD AND PASTURE FOR ABOUT 170 M (557.7 FT) TO THE SITE OF THE MARK IN A LANE BETWEEN 2.5 M (8.2 FT) HIGH WOVEN WIRE FENCES FOR FALLOW DEER, IN THE TOP OF A 0.15 M (0.49 FT) SQUARE CONCRETE MONUMENT WHICH PROJECTS 0.1 M (0.3 FT) ABOVE THE GROUND, 19.2 M (63.0 FT) NORTH OF THE CENTER OF A STEEL GATE AT THE SOUTH END OF THE LANE, 34.5 M (113.2 FT) SOUTH OF THE SOUTHEAST CORNER OF A PATCH OF WOODS, 1.9 M (6.2 FT) WEST OF THE FENCE ON THE EAST SIDE OF THE LANE, 2.3 M (7.5 FT) EAST OF THE FENCE ON THE WEST SIDE OF THE LANE.

• Description provided by Vermont Agency of Transportation Geodetic Survey Unit

HVCTRL 10812
Standard Disk Stamped

A94020
NORTH = 229452.595
EAST = 491506.585
ELEV. = 182.680

GENERAL LOCATION, MORRISTOWN, VT. TO REACH FROM THE CIVIL WAR MONUMENT AT THE INTERSECTION OF MAIN ST, ROUTE 12 AND 15A GO WEST ALONG MAIN ST FOR 0.15 MI (0.24 KM) TO THE TRAFFIC LIGHT AT THE INTERSECTION OF ROUTE 100, TURN RIGHT AND GO NORTH ALONG ROUTE 100 FOR 0.3 MI (0.5 KM) TO THE INTERSECTION OF BRIDGE ST CONTINUE STRAIGHT AHEAD AND GO WEST ALONG BRIDGE ST FOR 0.25 MI (0.40 KM) TO THE EAST END OF THE BRIDGE ST BRIDGE OVER THE LAMOILLE RIVER AND THE MARK ON THE RIGHT IN THE TOP OF THE WINGWALL AT THE NORTHEAST CORNER OF THE BRIDGE. THE MARK IS 5.2 M (17.1 FT) NORTH OF AND ABOUT LEVEL WITH THE CENTERLINE OF BRIDGE STREET.



TRAVERSE TIES

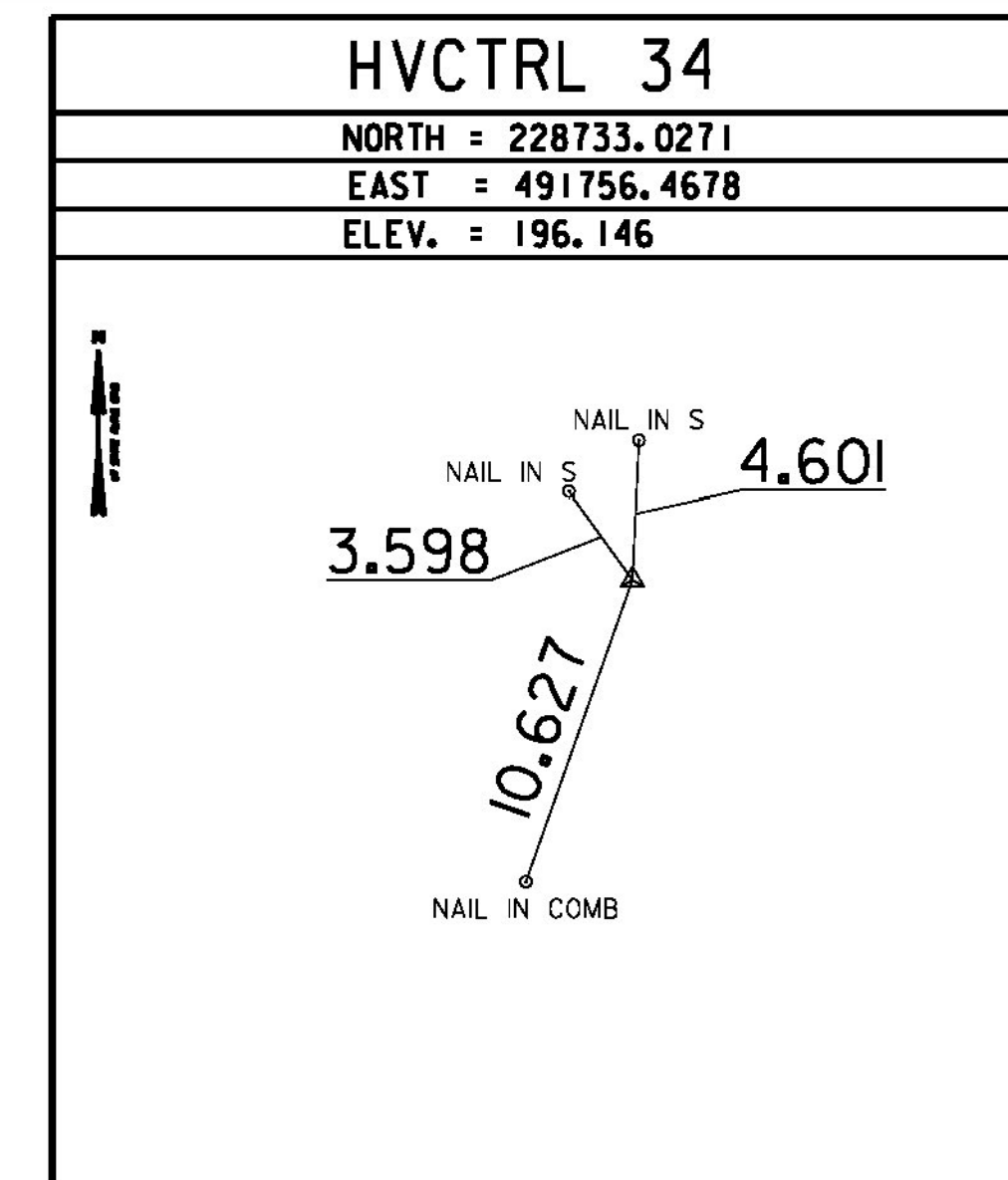
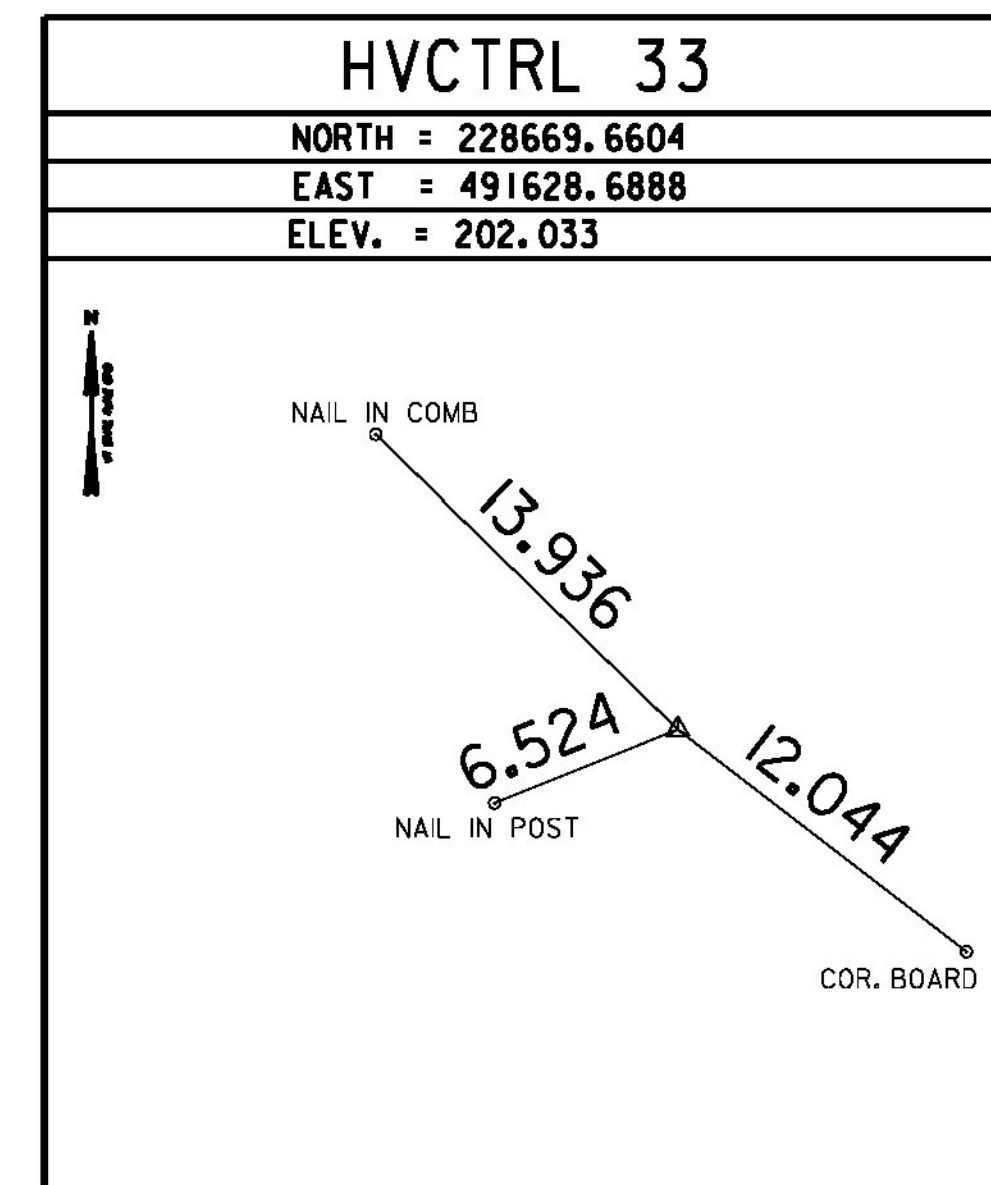
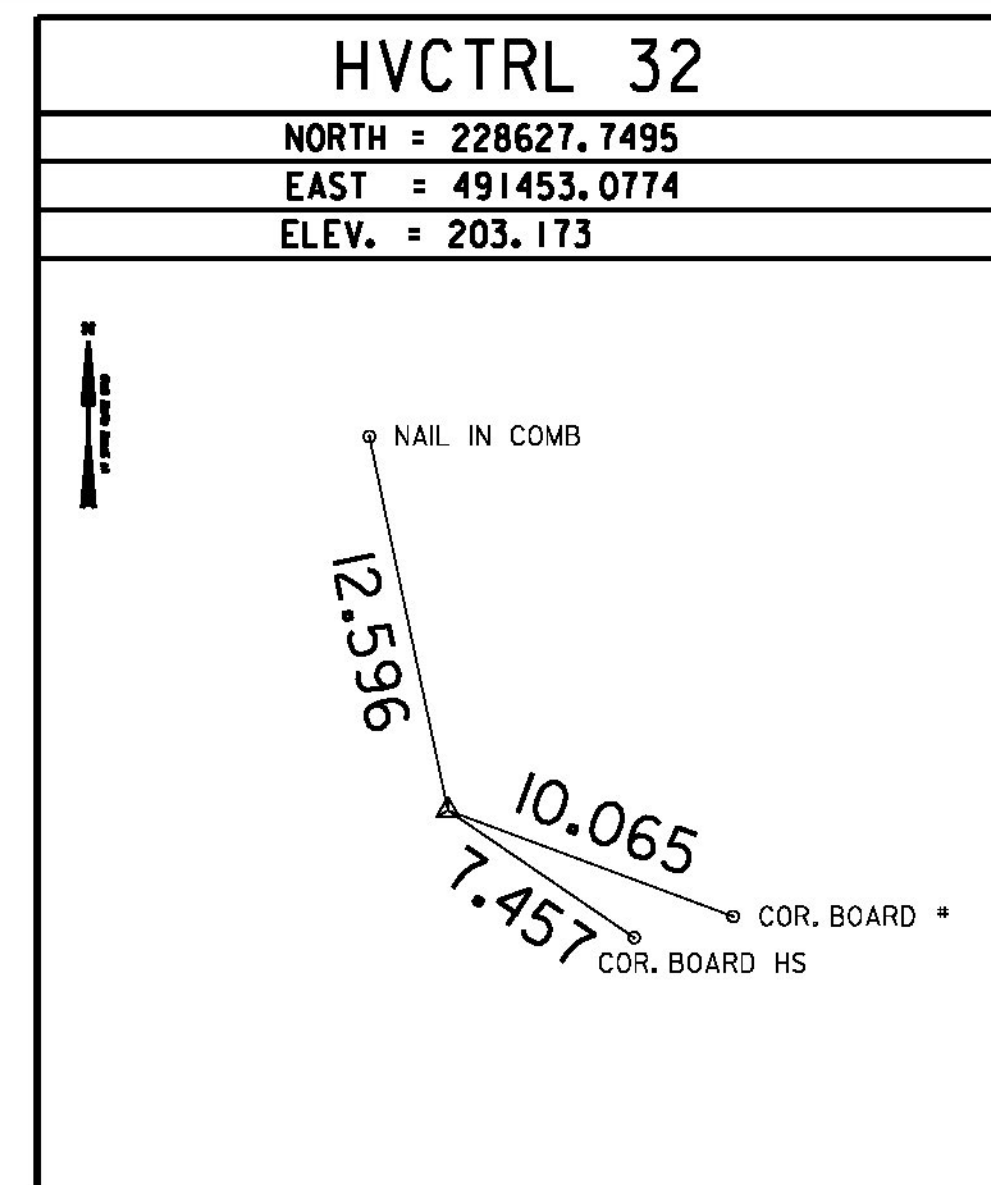
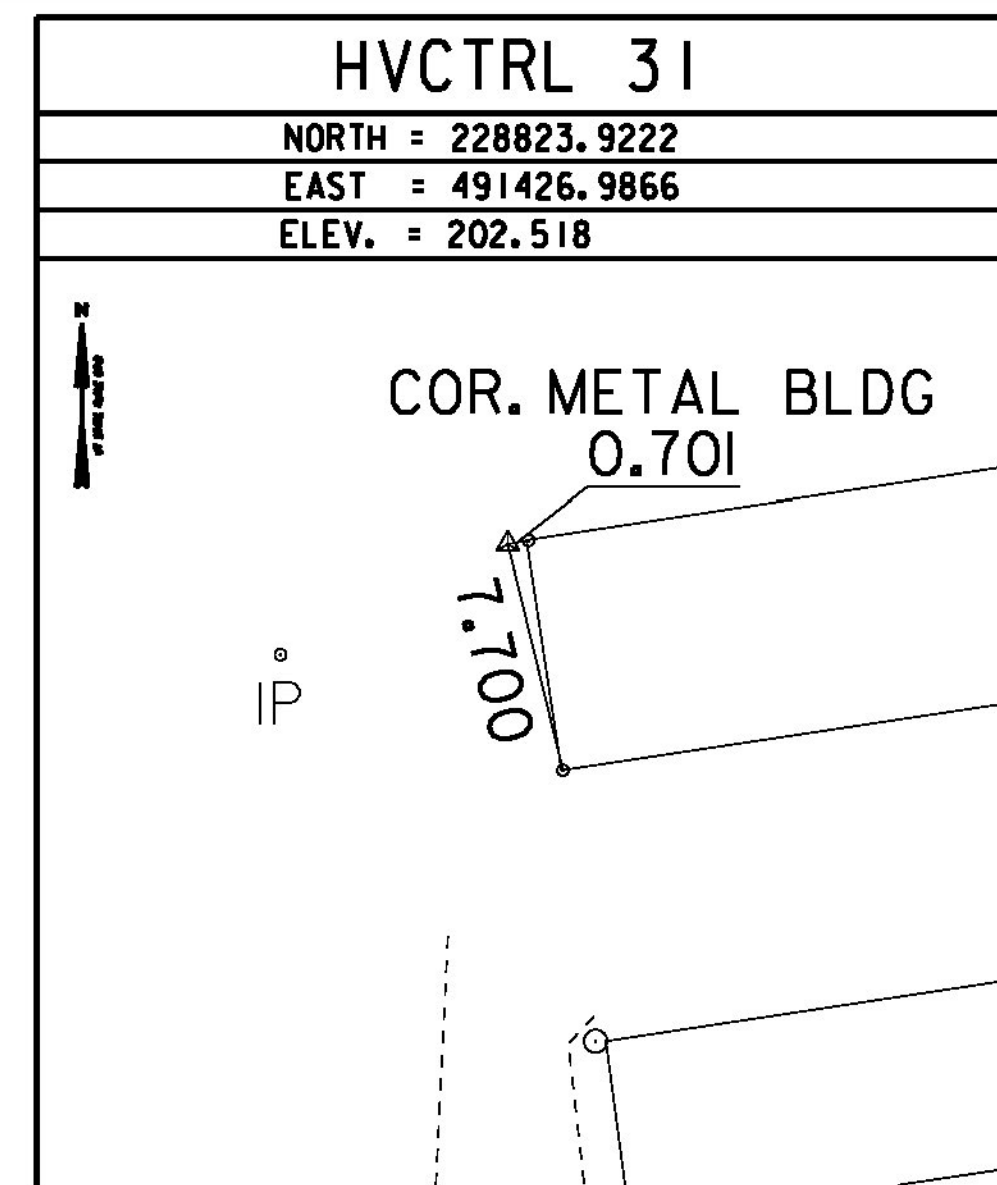
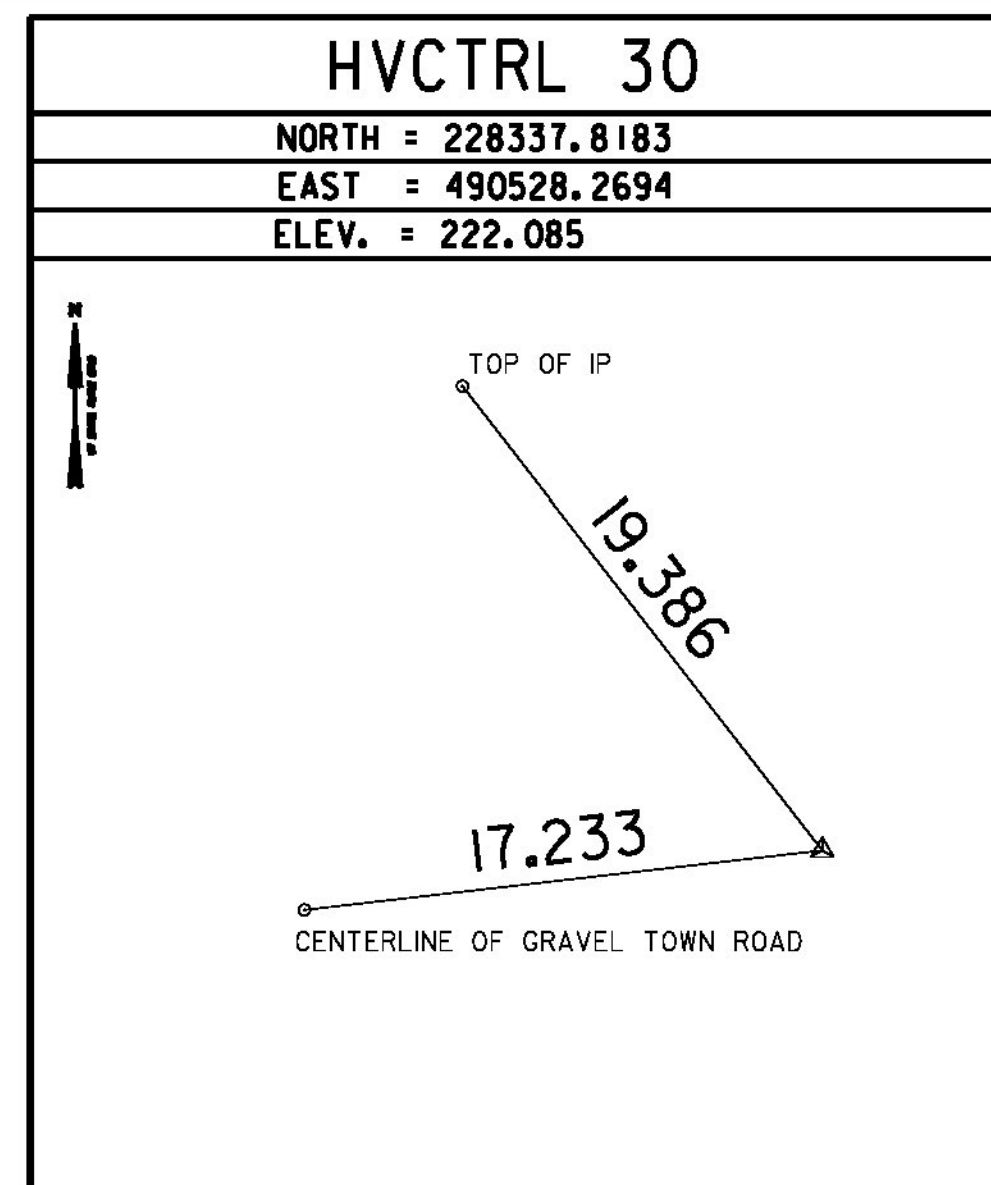

TRAVERSE TIES

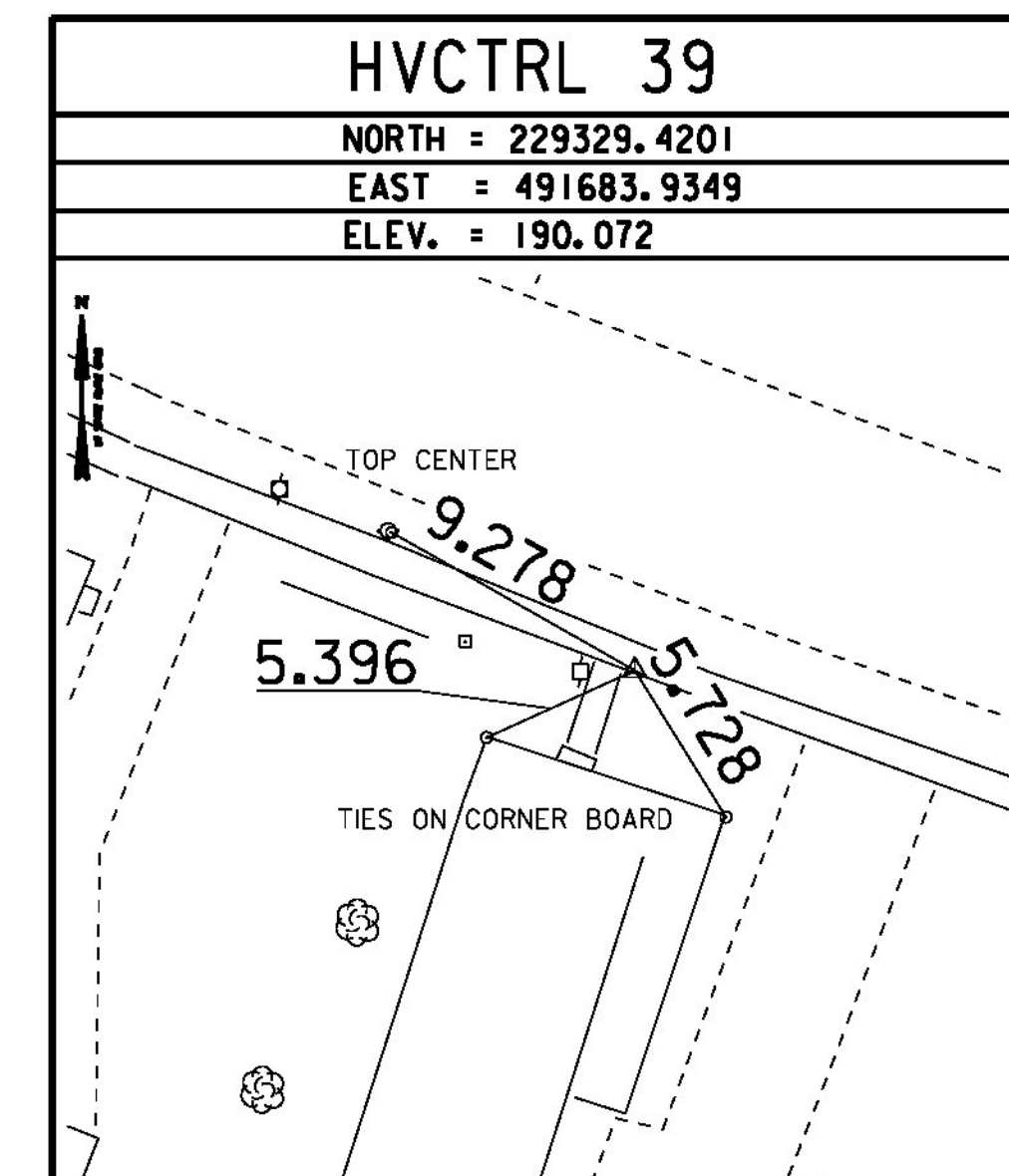
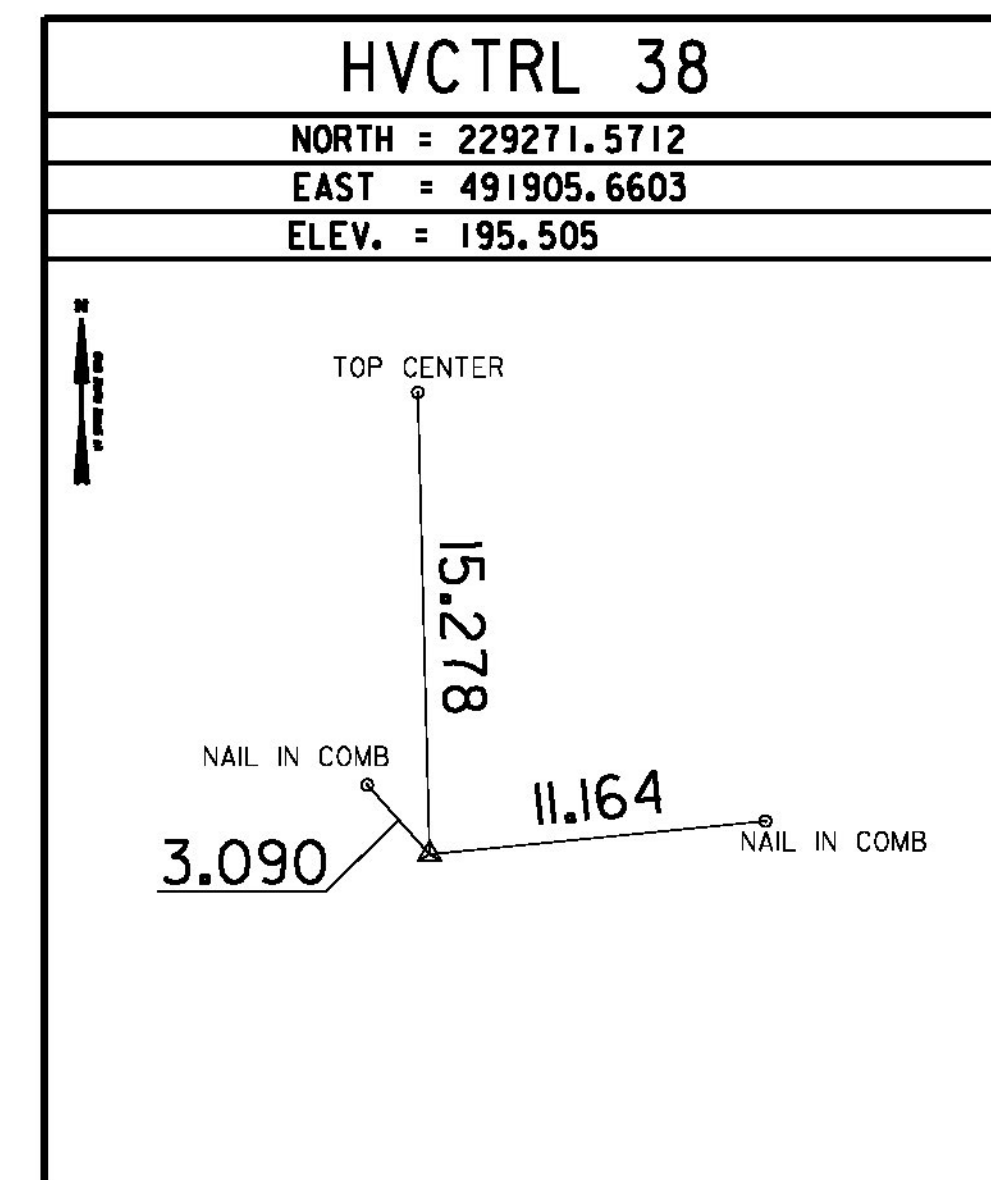
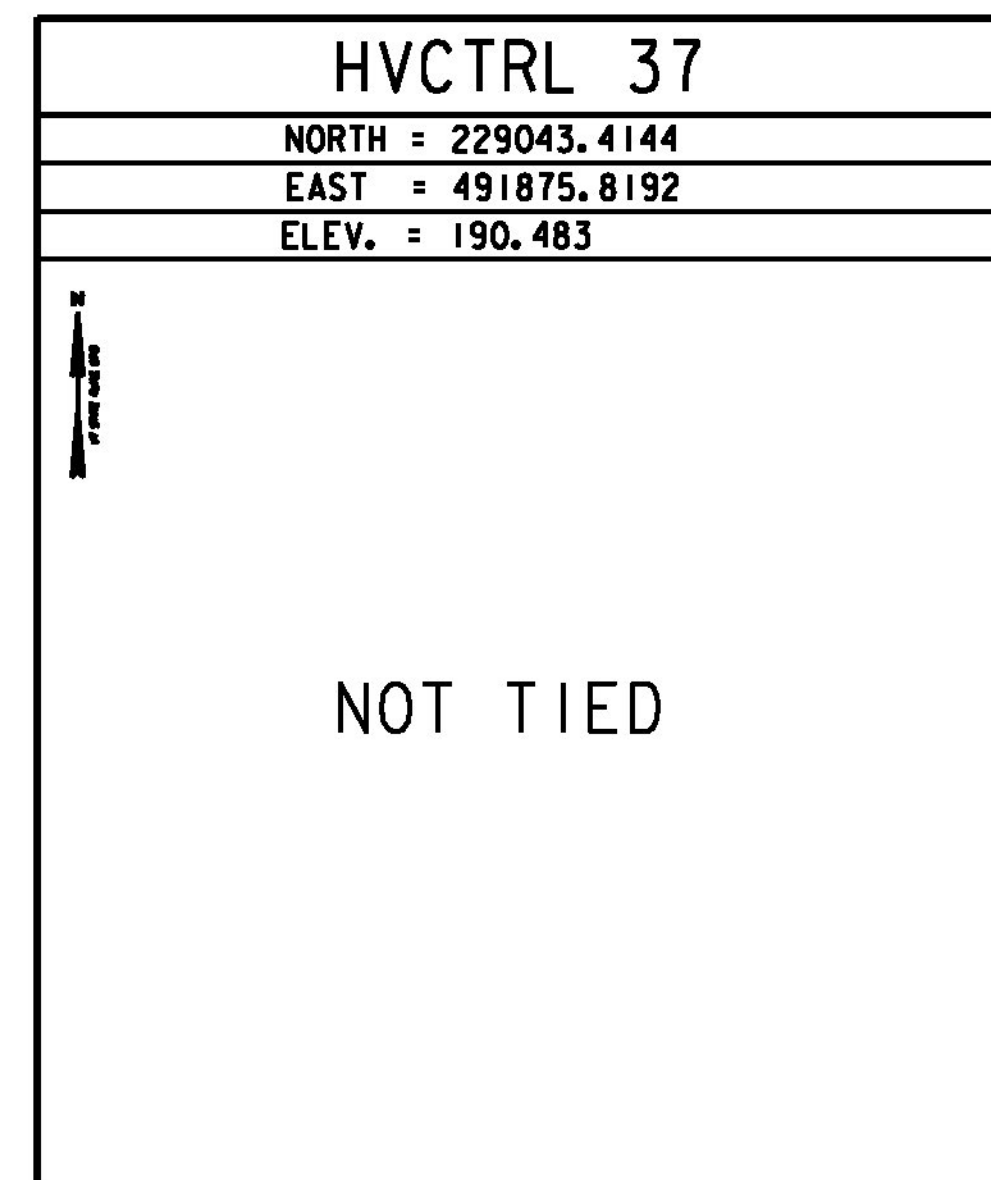
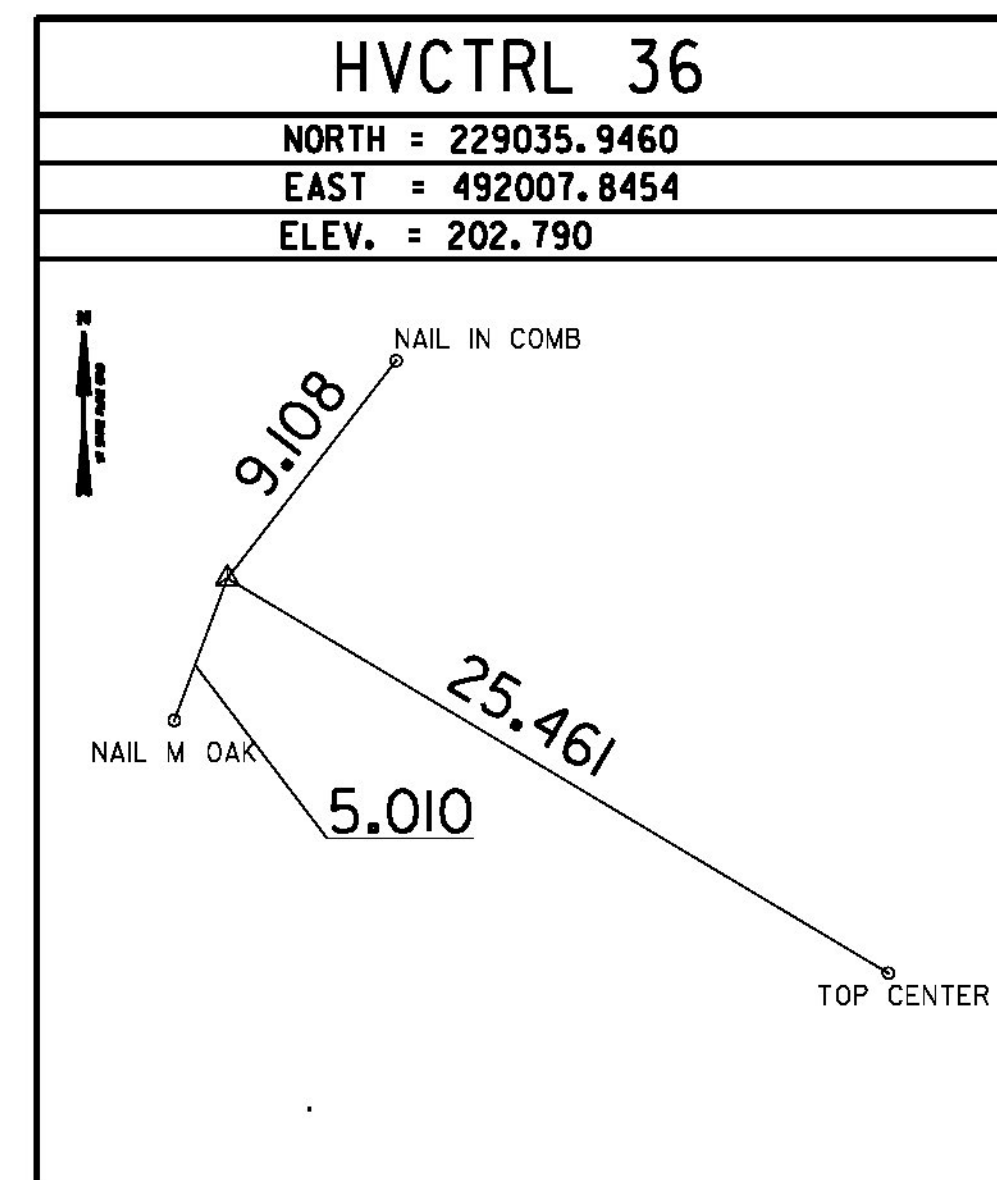
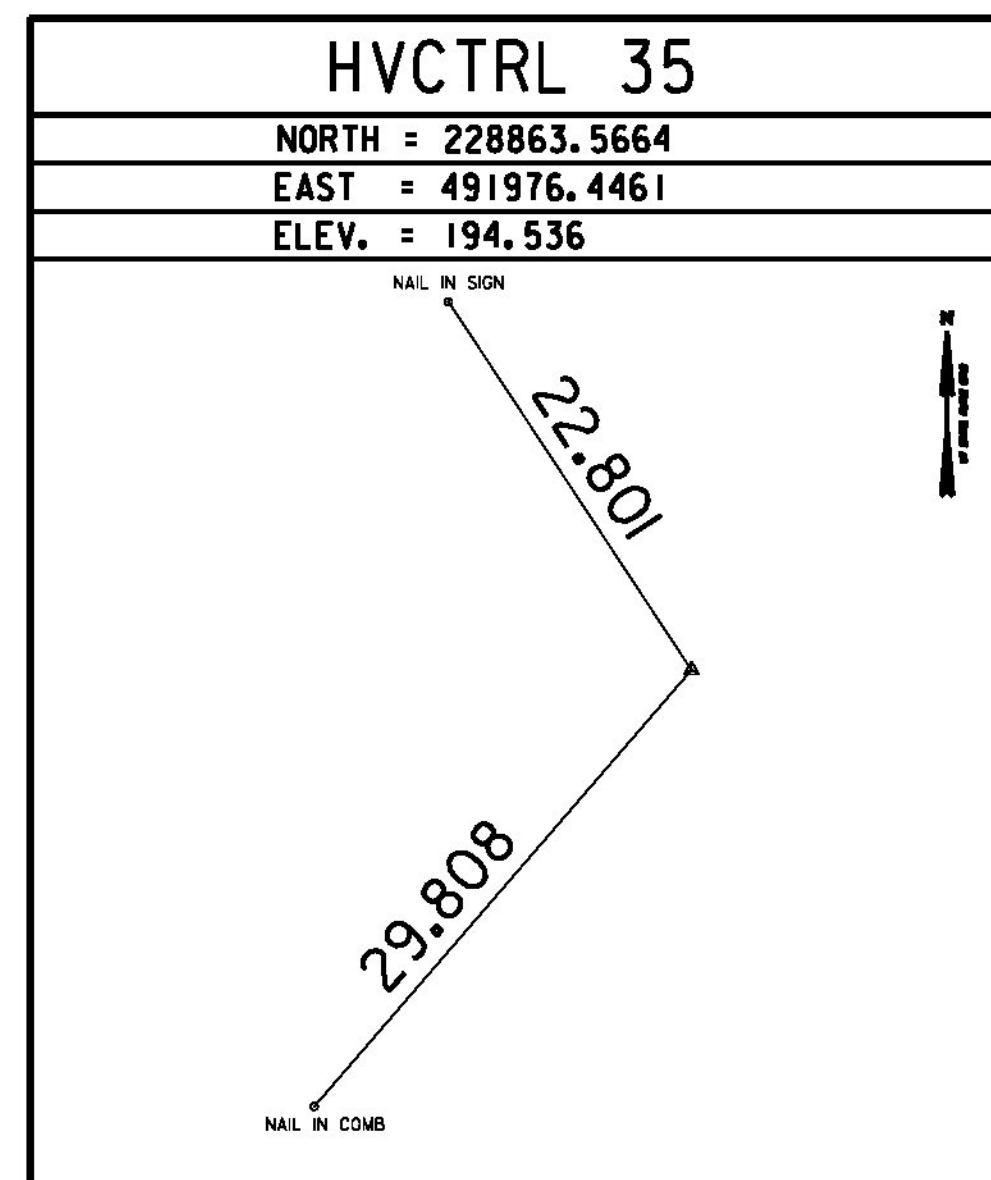

DATUM	
VERTICAL	NAVD 88
HORIZONTAL	NAD 83 (92)
ADJUSTMENT	Least Squares

NOTE: TRAVERSE TIES 31 & 39 ARE WITHIN THE LIMITS OF THIS PROJECT. OTHER TRAVERSE TIES ARE SHOWN FOR REFERENCE ONLY.

NOTE: ALL DIMENSIONS IN METERS (M) EXCEPT WHERE NOTED.

PROJECT NAME:	MORRISTOWN	PLOT DATE:	29-MAR-2012
PROJECT NUMBER:	STP F 029-1(2)C/1	DRAWN BY:	C. CYR
FILE NAME:	z10b19411e01.dgn	CHECKED BY:	DMB
PROJECT LEADER:	DMB	TIE INFORMATION SHEET - 1	SHEET 16 OF 123
DESIGNED BY:	BRC		

