

DELINEATOR TYPICAL

THE STANDARD COLOR FOR DELINEATORS USED ALONG BOTH SIDES OF TWO-WAY STREETS AND HIGHWAYS AND THE RIGHT SIDE OF ONE-WAY STREETS SHALL BE WHITE. DELINEATORS USED ALONG THE LEFT SIDE OF ONE-WAY ROADWAYS SHALL BE YELLOW. THEY SHALL HAVE A MINIMUM AREA OF 7 SQUARE INCHES. THEY MAY BE ROUND, SQUARE OR OBLONG, FOR ALTERNATES SEE STD. E-198

SYMBOL

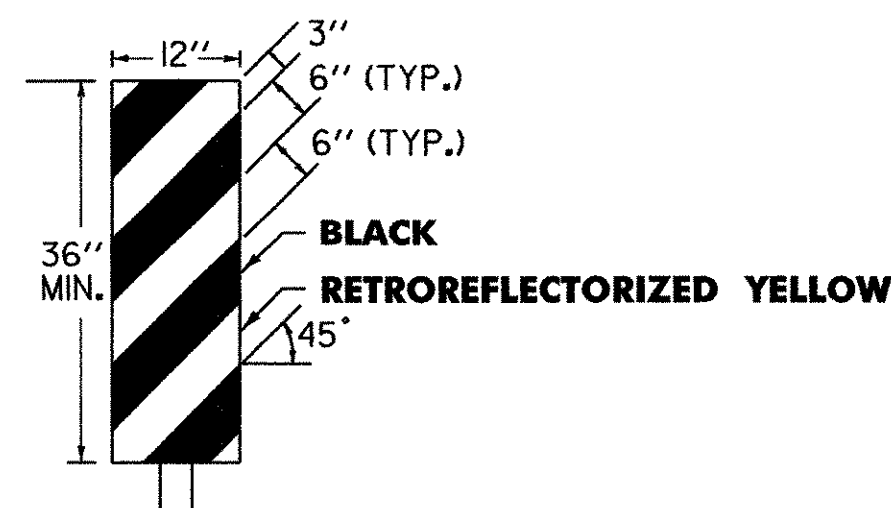

OBJECT MARKER TYPICAL

OBJECT MARKERS ARE USED TO MARK OBSTRUCTIONS WITHIN OR ADJACENT TO THE ROADWAY. IN SOME CASES THERE MAY NOT BE A PHYSICAL OBJECT INVOLVED, BUT OTHER ROADSIDE CONDITIONS SUCH AS NARROW SHOULDER DROP-OFFS, GORES, D.I. EXCAVATIONS, AND ABRUPT CHANGES IN THE ROADWAY ALIGNMENT MAY MAKE IT UNDESIRABLE FOR A DRIVER TO LEAVE THE ROADWAY. THE INSIDE EDGE OF THE OBJECT MARKER SHALL BE IN LINE WITH THE INNER EDGE OF THE OBSTRUCTION, WHENEVER POSSIBLE. OBJECT MARKERS SHALL HAVE ALTERNATING BLACK AND RETROREFLECTORIZED YELLOW STRIPES. (SLOPING DOWNWARD IN THE DIRECTION TRAFFIC IS TO PASS).

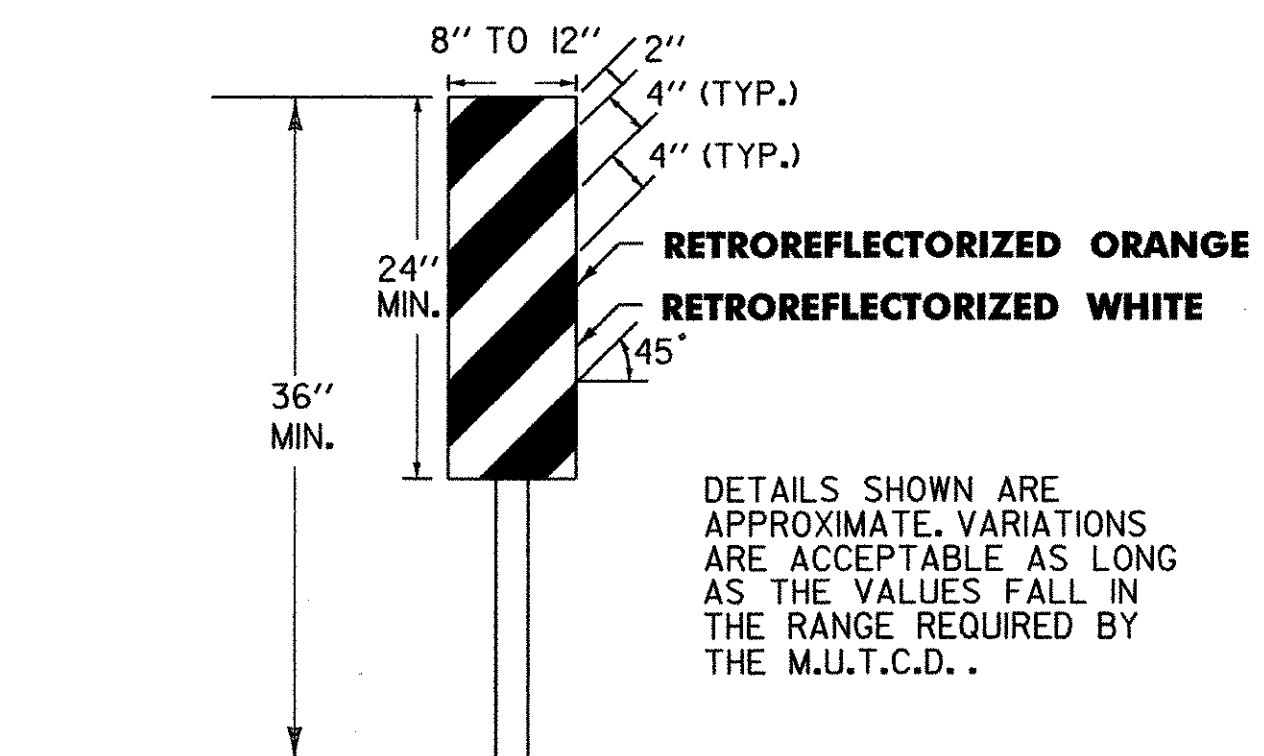

VERTICAL PANEL

VERTICAL PANELS SHALL HAVE ALTERNATING ORANGE AND WHITE RETROREFLECTORIZED STRIPES (SLOPING DOWNWARD IN THE DIRECTION TRAFFIC IS TO PASS). THESE DEVICES MAY BE USED FOR TRAFFIC SEPARATION, CHANNELIZING OR BARRICADING WHERE SPACE IS AT A MINIMUM.

DELINEATOR, VERTICAL PANEL AND OBJECT MARKER DETAILS FOR CONSTRUCTION AREAS WHERE TRAFFIC IS MAINTAINED

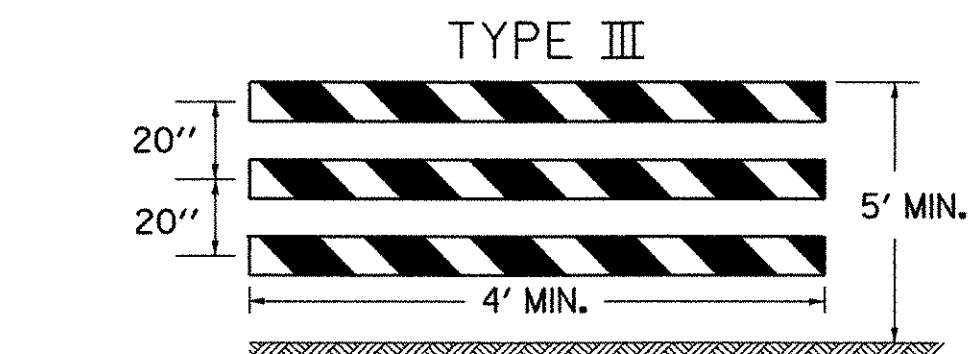
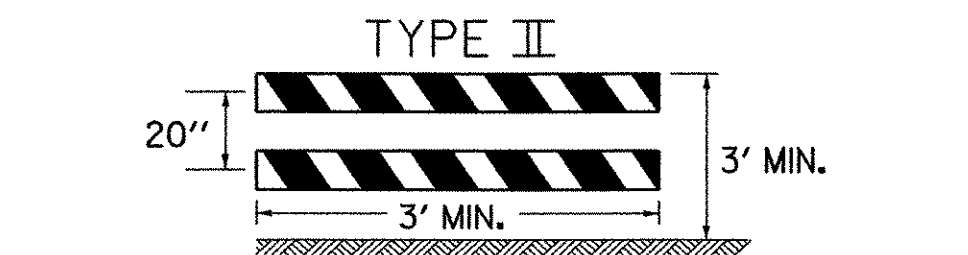
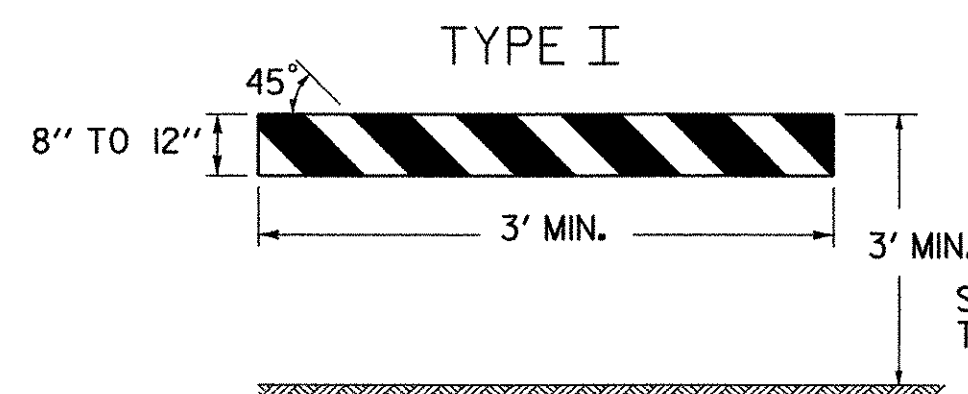

A TYPE III (MODIFIED) BARRICADE SHALL CONSIST OF TYPE II RAILS MOUNTED ON A BREAKAWAY BARRICADE AS SHOWN ON STANDARD SHEET E-107A.

BARRICADE CHARACTERISTICS			
	I	II	III
WIDTH OF RAIL	8" MIN. 12" MAX.	8" MIN. 12" MAX.	8" MIN. 12" MAX.
LENGTH OF RAIL	3' MIN.	3' MIN.	4' MIN.
WIDTH OF STRIPES	6"	6"	6"
HEIGHT	3' MIN.	3' MIN.	5' MIN.
TYPE OF FRAME	SEE E-107A	SEE E-107A	SEE E-107A
FLEXIBILITY	PORTABLE	PORTABLE	PORTABLE
ANGLE OF STRIPE	45°	45°	45°
COLOR OF STRIPES	ORANGE AND WHITE	ORANGE AND WHITE	ORANGE AND WHITE

BARRICADE CHARACTERISTICS

DETOUR DESIGN SPEED (M.P.H.)	MINIMUM RADIUS (FT.) ^a				
	SUPERELEVATION (FT./FT.)				
	0.00 ^b	0.02	0.04	0.06	0.08
20	160	140	130	120	110
25	245	220	200	185	170
30	375	335	305	275	255
35	510	455	410	375	340
40	715	630	575	510	470
50	1190	1045	955	850	765

a. PER AASHTO REQUIREMENTS
b. 0.00 SUPERELEVATION SHOULD BE AVOIDED IF POSSIBLE

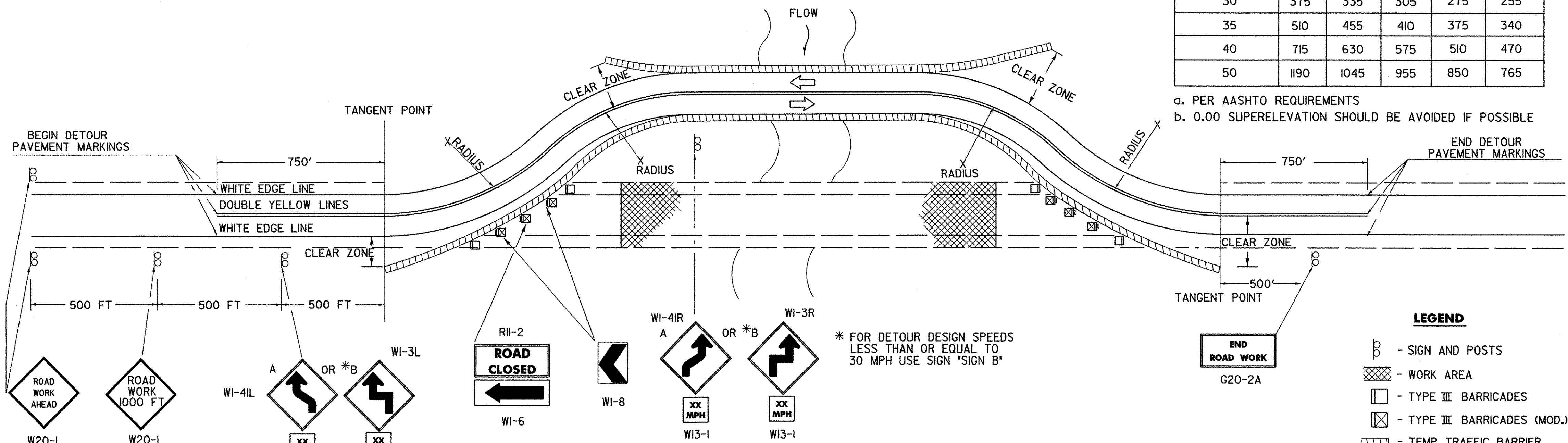

TRAFFIC CONTROL PLAN TWO LANE HIGHWAY PAVED DETOUR WITH TEMPORARY TRAFFIC BARRIER

LEGEND

- ⊕ - SIGN AND POSTS
- ▨ - WORK AREA
- - TYPE III BARRICADES
- ▧ - TYPE III BARRICADES (MOD.)
- ▤ - TEMP. TRAFFIC BARRIER
- ↔ - INDICATES TRAFFIC DIRECTION

BARRICADES

APPLICATION NOTES

TYPE I BARRICADES SHALL BE USED ON CONVENTIONAL ROADS OR URBAN STREETS AND ARTERIALS TO MARK A SPECIFIC HAZARD.

TYPE II BARRICADES SHALL BE USED ON EXPRESSWAYS AND FREEWAYS, SERVING THE SAME FUNCTIONS AS TYPE I BARRICADES.

TYPE III BARRICADES (SEE STD. E-107A) SHALL ONLY BE USED WHEN A ROAD SECTION OR LANE IS CLOSED TO TRAFFIC AND ARE TO BE ERECTED AT THE POINT OF CLOSURE.

MATERIALS

THE BARRICADES SHOWN ON THIS SHEET SHOULD BE OF LIGHTWEIGHT MATERIAL. IF WOOD IS USED THE FOLLOWING CONDITIONS SHALL APPLY:

1. WOODEN BARRICADES (TYPE I AND II)
 - A) SHALL NOT BE USED TO CHANNELIZE OR DELINEATE WORK AREAS WITHIN THE CLEAR ZONE OF ANY HIGHWAY WHERE OPERATING SPEEDS IN EXCESS OF 20 M.P.H. ARE EXPECTED UNLESS INSTALLED FOR PEDESTRIAN CONTROL BEHIND APPROVED POSITIVE BARRIERS.
 - B) MAY BE USED WHERE OPERATING SPEEDS OF 20 M.P.H. OR LESS ARE EXPECTED.
2. TYPE III WOODEN BARRICADES SHALL NOT BE USED.

COLORS

THE BARRICADE PANELS SHOWN ON THIS SHEET SHALL HAVE ALTERNATING RETRO-REFLECTORIZED WHITE AND ORANGE STRIPES. THE ORANGE SHALL CONFORM WITH THE STANDARD COLORS ADOPTED BY AMERICAN ASSOCIATION OF STATE HIGHWAY AND TRANSPORTATION OFFICIALS AND APPROVED BY THE US DEPARTMENT OF TRANSPORTATION FEDERAL HIGHWAY ADMINISTRATION. THE BARRICADE COMPONENTS SHALL BE WHITE UNLESS UNPAINTED METAL OR ALUMINUM IS USED.

REFLECTORIZATION

THE RETROREFLECTIVE SHEETING ON BARRICADE PANELS SHALL BE ASTM TYPE III.

LOCATION

THE BARRICADES SHOWN ON THIS SHEET WILL BE LOCATED BY THE RESIDENT ENGINEER IN THE FIELD OR AS SHOWN ON THE PLANS. THE LOCATION OF THE BARRICADES SHALL FOLLOW THE PROCEDURES SET FORTH IN THE "MANUAL ON UNIFORM TRAFFIC CONTROL DEVICES", OR AS OTHERWISE NOTED.

MAINTENANCE

BARRICADES SHALL BE MAINTAINED IN CLEAN CONDITION, SATISFACTORY TO THE RESIDENT ENGINEER. THEY SHALL BE COMPLETELY VISIBLE TO THE APPROACHING TRAFFIC AT ALL TIMES. DAMAGED, DEFACTED, OR DIRTY BARRICADES SHALL BE REPAIRED, CLEANED, OR REPLACED AS ORDERED BY THE RESIDENT ENGINEER.

DETOUR NOTES

- 1.) SIGNS AND DELINEATION SHOWN FOR ONE DIRECTION OF TRAFFIC ONLY.
- 2.) THE CONTRACTOR IS RESPONSIBLE FOR PAVEMENT MARKING AND SHALL REMOVE ANY CONFLICTING OR CONFUSING EXISTING MARKINGS.
- 3.) ADDITIONAL SIGNING MAY BE REQUIRED AT THE DISCRETION OF THE RESIDENT ENGINEER.
- 4.) UNPAVED DETOURS REQUIRE PAVEMENT MARKINGS FOR TRANSITIONS FROM EXISTING PAVEMENT.
- 5.) THE NUMBER OF CHANNELIZING DEVICES, BARRICADES AND OTHER TRAFFIC CONTROL DEVICES SHOWN ON THIS SHEET ARE FOR ILLUSTRATIVE PURPOSES ONLY. THE ACTUAL NUMBER REQUIRED SHALL BE DETERMINED BASED ON INDIVIDUAL DETOUR CONDITIONS (TAPERS, SPEED LIMITS, LENGTH OF DETOUR CURVE, ETC.).
- 6.) AASHTO CLEAR ZONE REQUIREMENTS SHOULD BE MET. IF NOT THEN AN APPROVED ENERGY ABSORPTION ATTENUATOR (SUITABLE FOR THE TEMPORARY TRAFFIC BARRIER USED AND FOR THE DESIGN SPEED) SHALL BE INSTALLED PER THE CURRENT AASHTO ROADSIDE DESIGN GUIDE.
- 7.) THE DETOUR DESIGN SPEED SHOULD BE NO LESS THAN 10 M.P.H. BELOW THE POSTED SPEED LIMIT, UNLESS PHYSICAL RESTRICTIONS PREVENT THIS.
- 8.) SEE STANDARD SHEETS E-100, E-101 AND E-102 FOR SIGN DETAIL AND MATERIAL REQUIREMENTS.
- 9.) IF THE USE OF TEMPORARY TRAFFIC BARRIER IS NOT REQUIRED, THEN REFLECTORIZED PLASTIC DRUMS SHALL BE USED.

OTHER STDS. REQUIRED: E-100 E-101 E-102 E-102a E-107a E-198

REVISIONS AND CORRECTIONS
 SEPT. 10, 1987 - DATE OF ORIGINAL ISSUE
 APRIL 29, 1988 - FHWA REVIEW COMMENTS
 SEPT. 20, 1993 - NEW RADIUS CHART, BARRICADE ALIGNMENT AND USE OF TEMPORARY TRAFFIC BARRIER
 AUG. 08, 1995 - REVISED SIGNING PER MUTCD
 JUNE 30, 2003 - CHANGED REFLECTIVE SHEETING TO TYPE III

APPROVED
 DIRECTOR OF PROGRAM DEVELOPMENT
 TRAFFIC OPERATIONS ENGINEER
 FEDERAL HIGHWAY ADMINISTRATION

DELINEATION, BARRICADES AND DETOURS FOR CONSTRUCTION AREAS

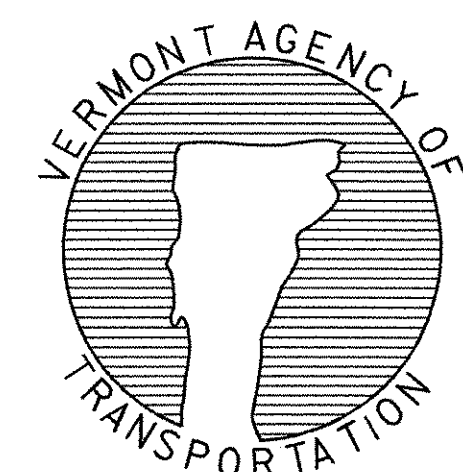

STANDARD E-107