

**W2-1Mb**  
DIMENSIONS NOT SHOWN  
FOR THIS DETAIL SHALL CONFORM  
TO THE LATEST EDITION OF THE 2003 MUTCD  
FOR SIGN DETAIL W2-1.  
UNLESS OTHERWISE NOTED FOR THIS DETAIL

SIGN	DIMENSIONS (IN)		
	A	G	H
MIN & STD.	30	11	3
SPECIAL	36	13	4

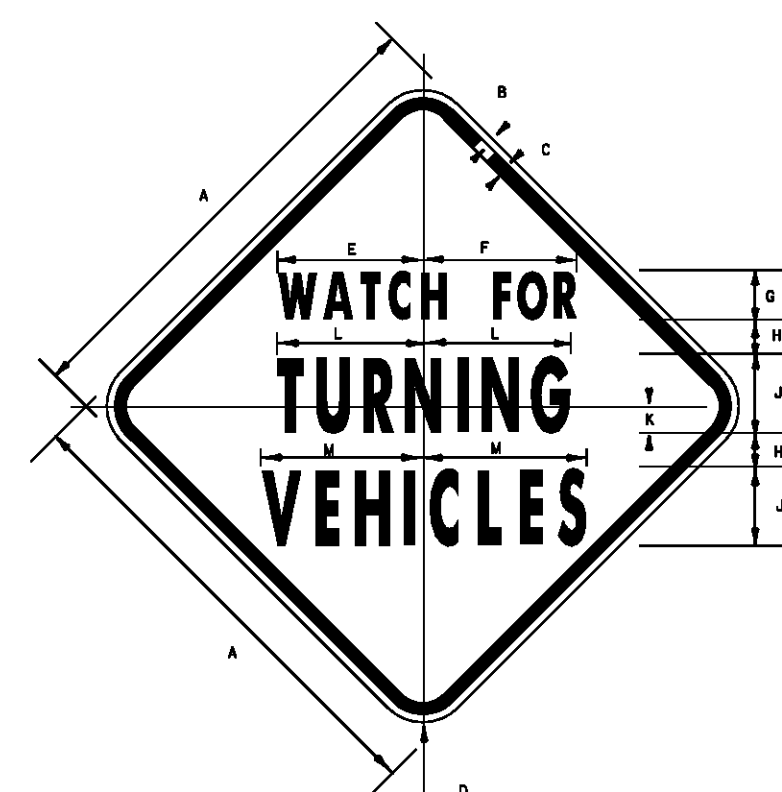

VW-205

SIGN	DIMENSIONS (INCHES)											
	A	B	C	D	E	F	G	H	J	K	L	M
MIN.	30	1/2	3/4	1 1/4	9 3/4	9 3/4	4 1/2	2	5 1/2	2	9 1/4	10 1/4
STD.	36	3/4	1	1 1/4	12	12	4 1/2	2 1/2	6	2	11 1/2	12 1/2
EXPIRY.	48	3/4	1 1/4	3	14 3/4	15 3/4	5 1/2	3 3/4	8 1/2	2 1/2	14 1/4	16 1/4

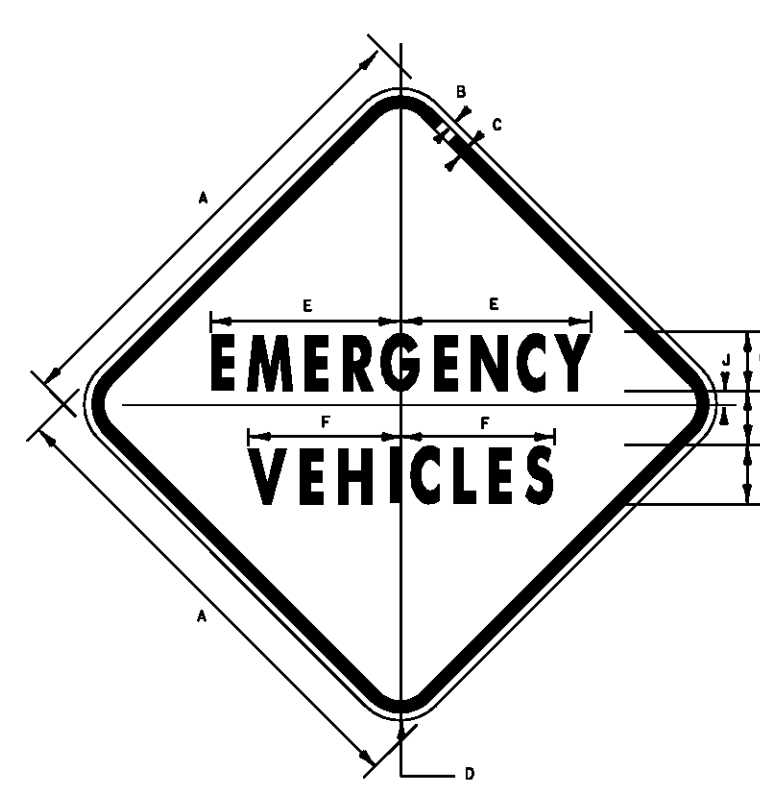

VW-544

• LETTER SPACING REDUCED 50%

SIGN	DIMENSIONS (INCHES)									
	A	B	C	D	E	F	G	H	J	K
MIN.	30	1/2	3/4	1 1/4	12 3/4	12 3/4	9 3/4	4 1/2	3 3/4	7 1/4
STD.	36	3/4	1	1 1/4	14 3/4	14 3/4	10 3/4	5 1/2	4	11
EXPIRY.	48	3/4	1 1/4	3	17 3/4	17 3/4	13 3/4	6 1/2	5 1/2	13 1/4

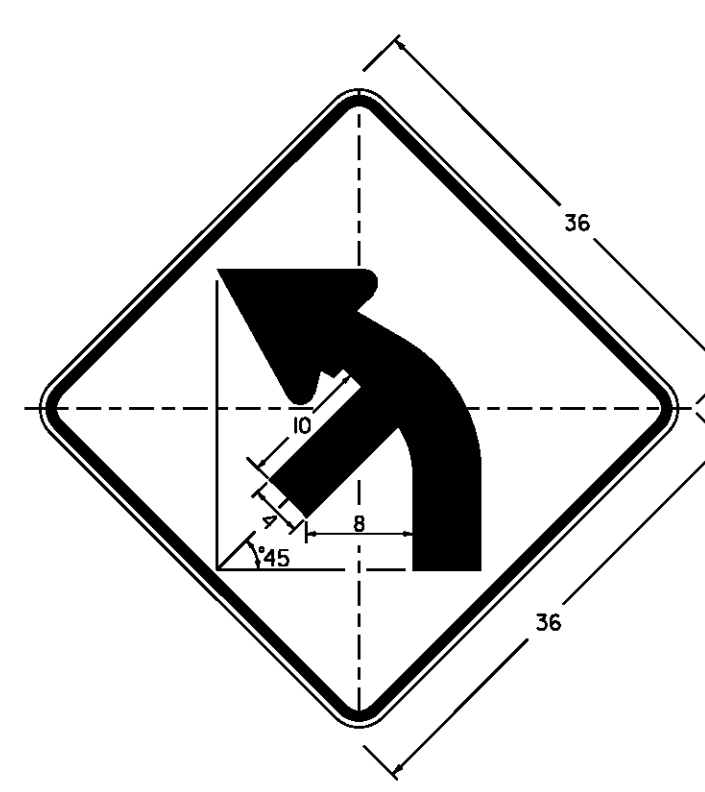

**W1-2Mb L(R)**

DIMENSIONS NOT SHOWN  
FOR THIS DETAIL SHALL CONFORM  
TO THE LATEST EDITION OF THE 2004  
STANDARD HIGHWAY SIGN MANUAL  
FOR SIGN DETAIL W1-2.  
UNLESS OTHERWISE NOTED FOR THIS DETAIL

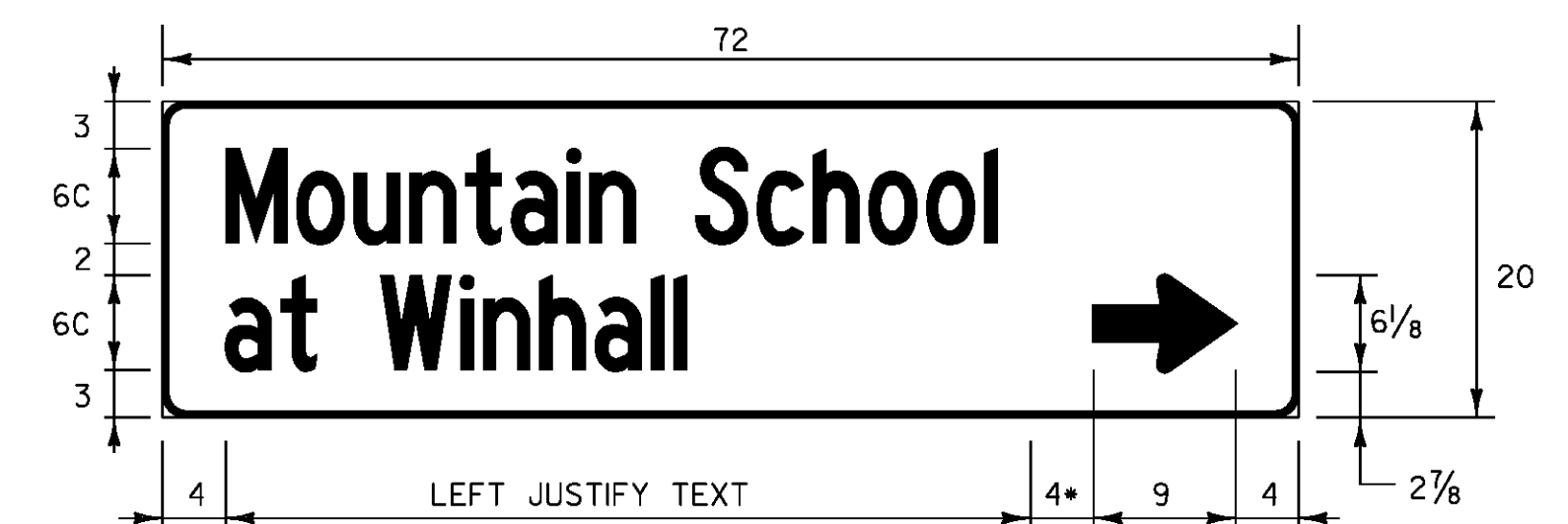

**VDI-2 (R)**

• MINIMUM DISTANCE BETWEEN ARROW AND TEXT

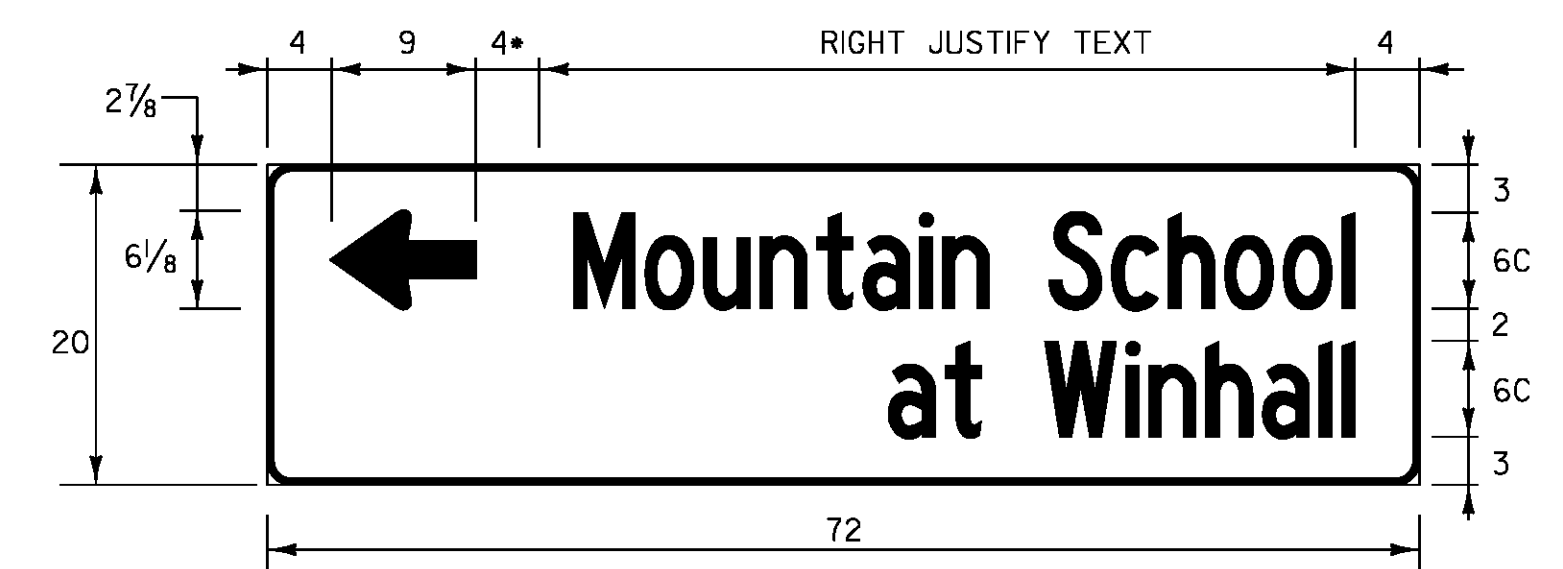

**VDI-2 (L)**

• MINIMUM DISTANCE BETWEEN ARROW AND TEXT

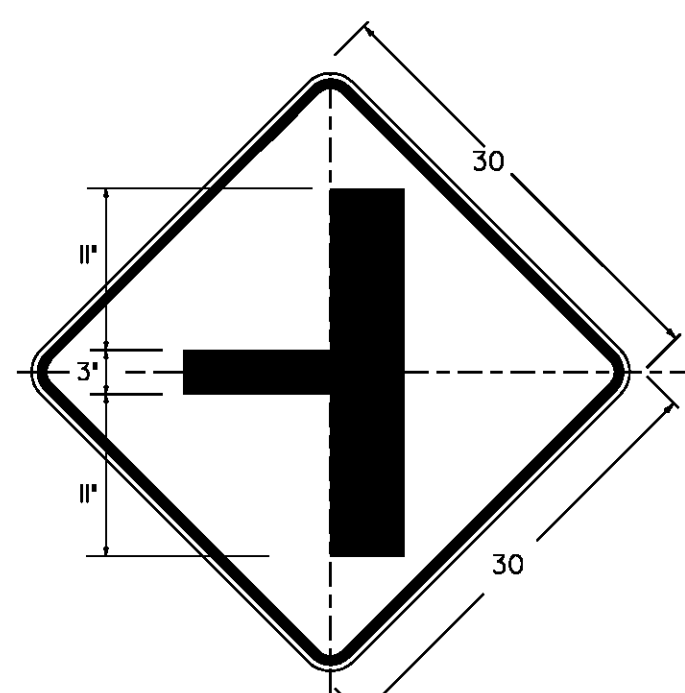

**W2-2M L(R)**  
DIMENSIONS NOT SHOWN  
FOR THIS DETAIL SHALL CONFORM  
TO THE LATEST EDITION OF THE  
2004 STANDARD HIGHWAY SIGN MANUAL  
FOR SIGN DETAIL W2-2.  
UNLESS OTHERWISE NOTED FOR THIS DETAIL

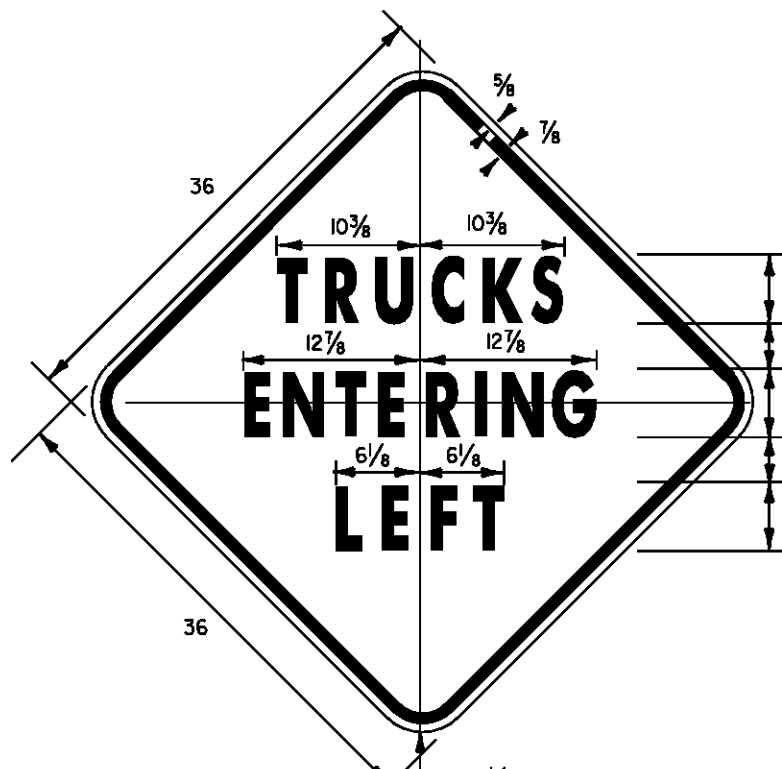

VW-084

1.875" RADIUS, 0.75" BORDER, 0.50" INDENT  
COLORS: LEGEND - BLACK  
BACKGROUND - YELLOW  
TEXT STYLE: C

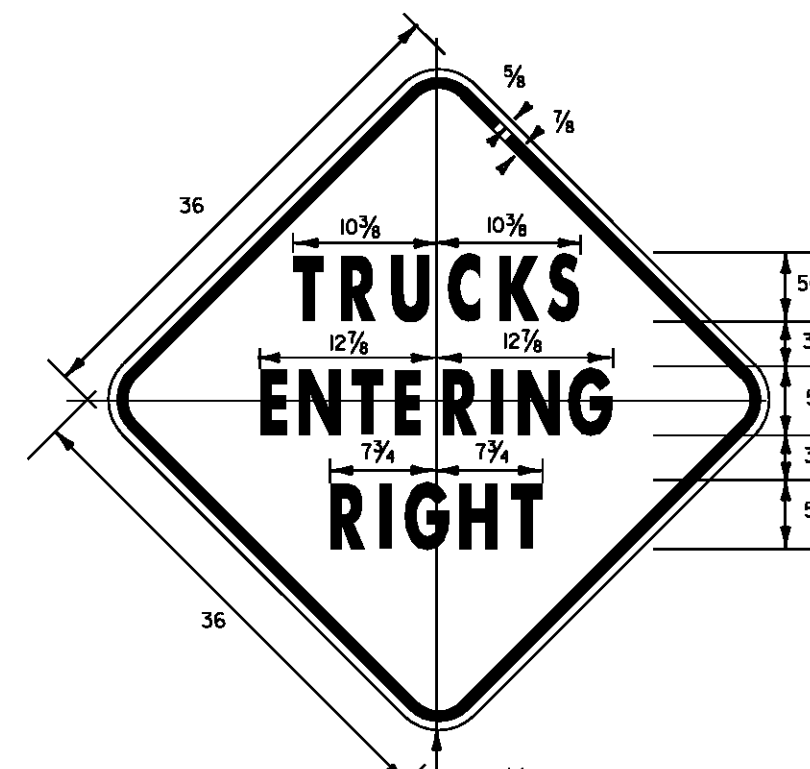

VW-081

1.875" RADIUS, 0.75" BORDER, 0.50" INDENT  
COLORS: LEGEND - BLACK  
BACKGROUND - YELLOW  
TEXT STYLE: C

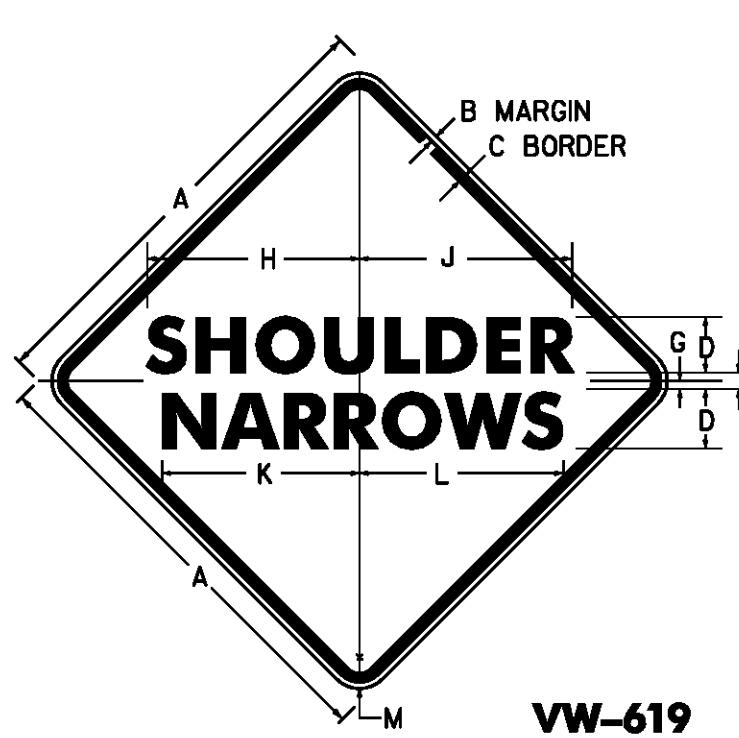

**VW-619**

SIGN	DIMENSIONS (INCHES)											
	A	B	C	D	E	F	G	H	J	K	L	M
MIN & STD.	36	3/4	1 1/4	3	6D	1	13 3/4	13 3/4	17 3/4	18 1/4	2 1/4	
EXPIRY.	48	3/4	1 1/4	7D	3 1/2	7D	1	23 3/4	23 3/4	27 3/4	3	

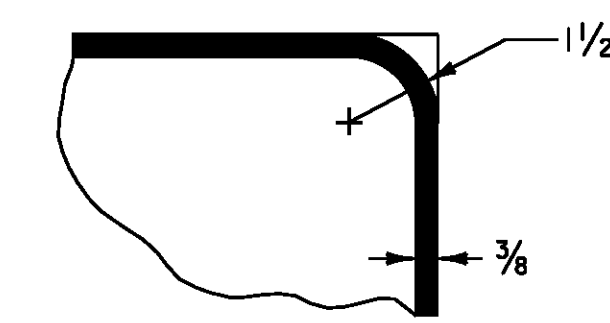

**BORDER DETAIL**  
(FOR DESTINATION SIGN)

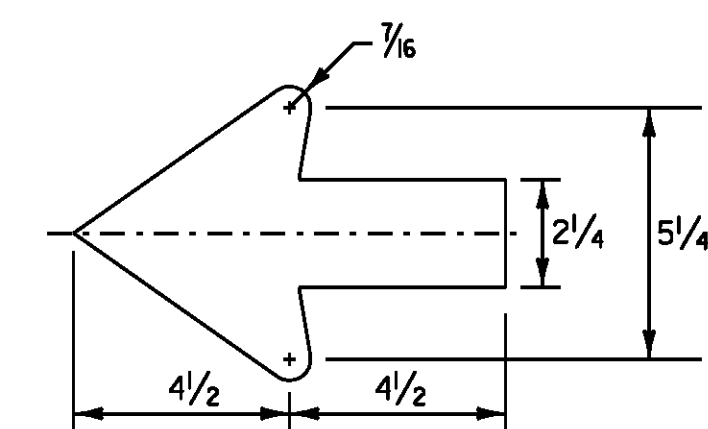

**STANDARD 2.25" ARROW**  
(FOR DESTINATION SIGN)

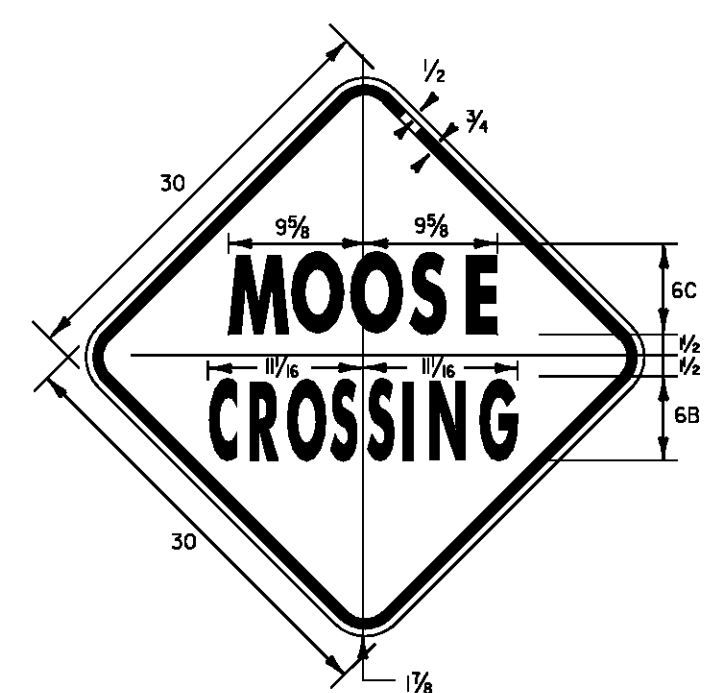

VW-000

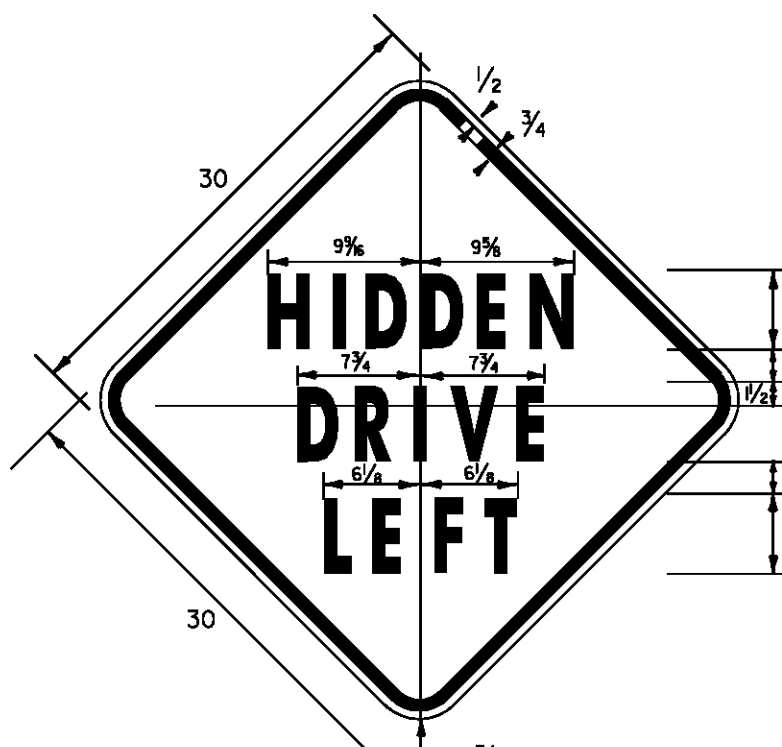

VW-133

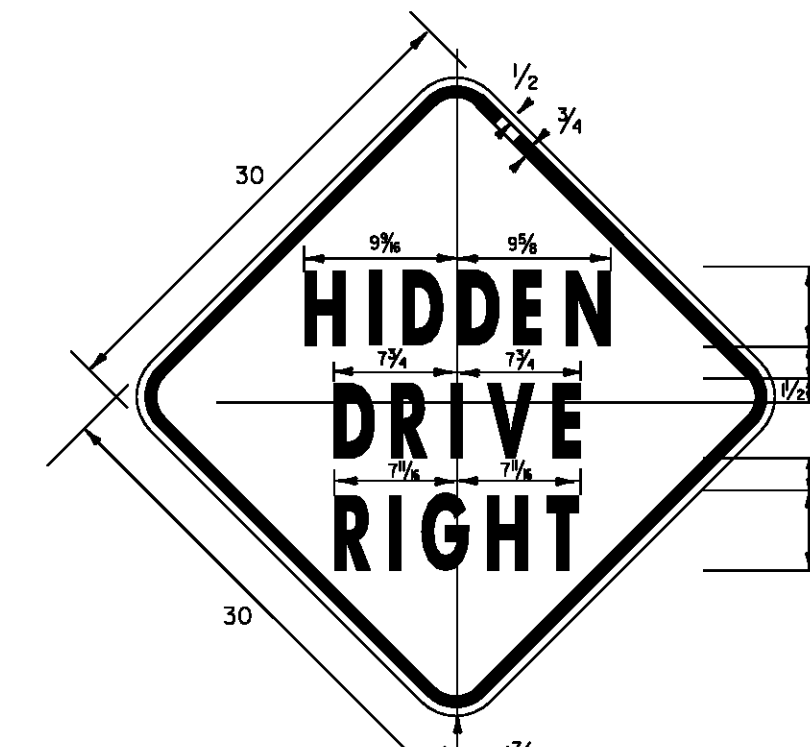

VW-054

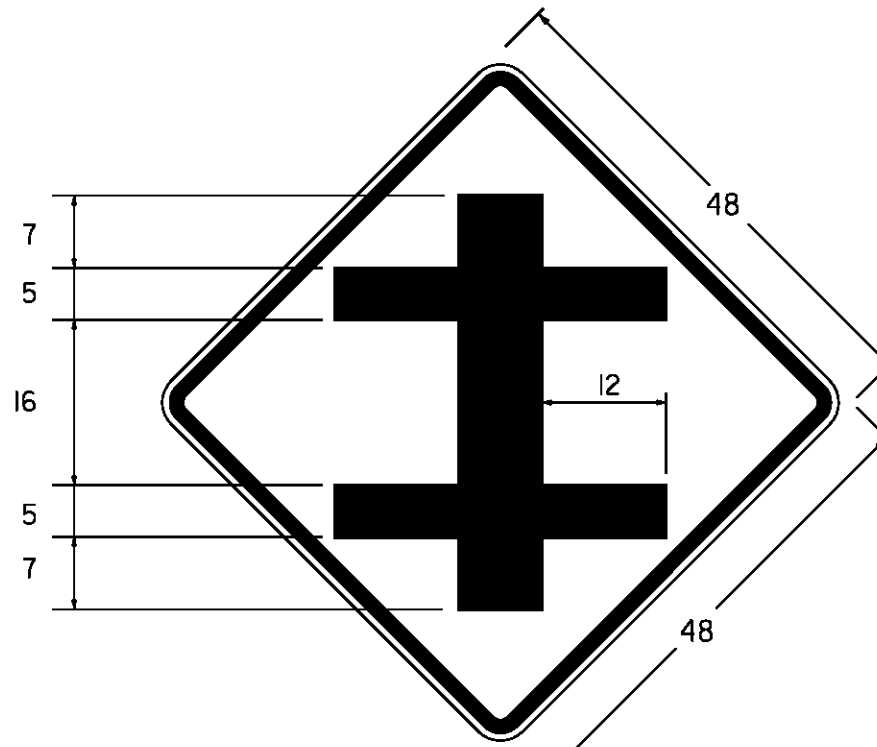

**W2-1M**

DIMENSIONS NOT SHOWN  
FOR THIS DETAIL SHALL CONFORM  
TO THE LATEST EDITION OF THE  
2004 STANDARD HIGHWAY SIGN MANUAL  
FOR SIGN DETAIL W2-1.  
UNLESS OTHERWISE NOTED FOR THIS DETAIL

PROJECT NAME: STATEWIDE - SOUTHWEST REGION

PROJECT NUMBER: STPG SIGN (32)

FILE NAME: I0B012.TS.DGN  
PROJECT LEADER: A. GAMBLE  
DESIGNED BY: J. KELLY  
SIGN DETAILS (3)

PLOT DATE: 03-SEP-2010  
DRAWN BY: J. KELLY  
CHECKED BY: A. GAMBLE  
SHEET 6 OF 90