

**W2-2Ma L(R)**

DIMENSIONS NOT SHOWN FOR THIS DETAIL SHALL CONFORM TO THE LATEST EDITION OF THE 2009 MUTCD FOR SIGN DETAIL W2-2, UNLESS OTHERWISE NOTED FOR THIS DETAIL

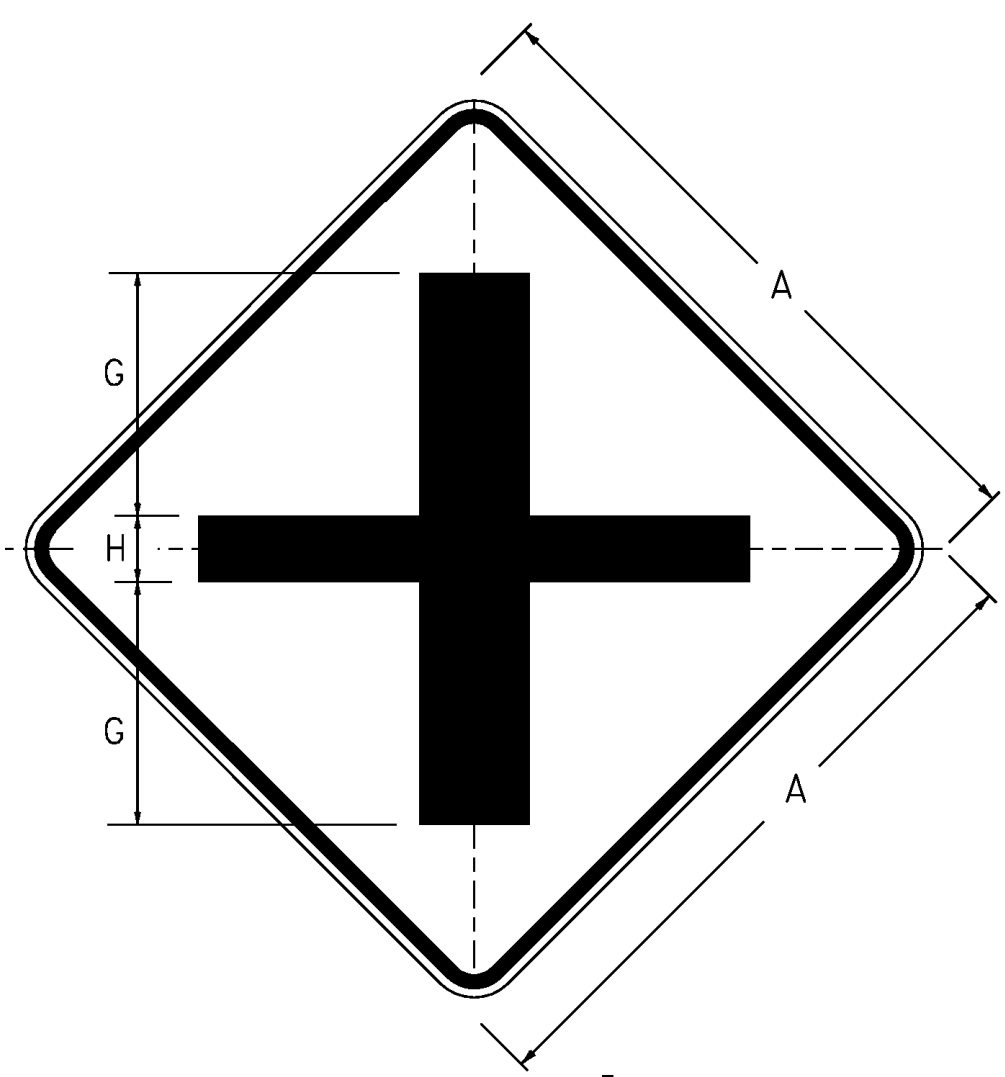

**W2-1Mb**

DIMENSIONS NOT SHOWN FOR THIS DETAIL SHALL CONFORM TO THE LATEST EDITION OF THE 2009 MUTCD FOR SIGN DETAIL W2-1, UNLESS OTHERWISE NOTED FOR THIS DETAIL

SIGN	DIMENSIONS ( IN )		
	A	G	H
MIN & STD.	30	11	3
SPECIAL	36	13	4

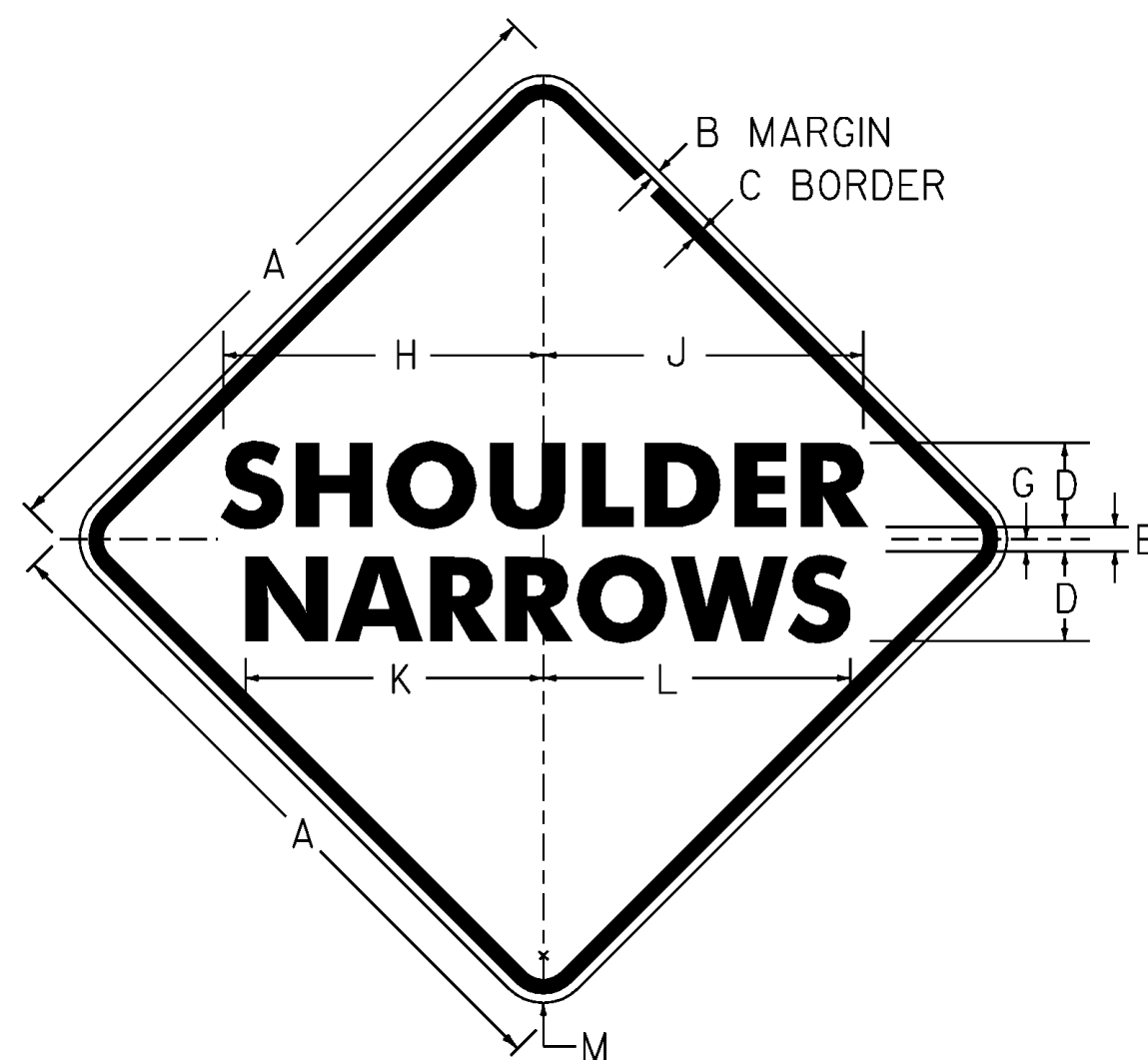

**VW-619**

COLORS: LEGEND - BLACK BACKGROUND - YELLOW

SIGN	DIMENSIONS ( INCHES )											
	A	B	C	D	E	F	G	H	J	K	L	M
MIN & STD.	36	5/8	7/8	5C	3	6D	I	13 1/16	13 1/16	17 5/8	18 1/4	2 1/4
EXPWY.	48	3/4	1 1/4	7D	3 1/2	7D	I	23 3/16	23 3/8	21 1/2	21 3/16	3

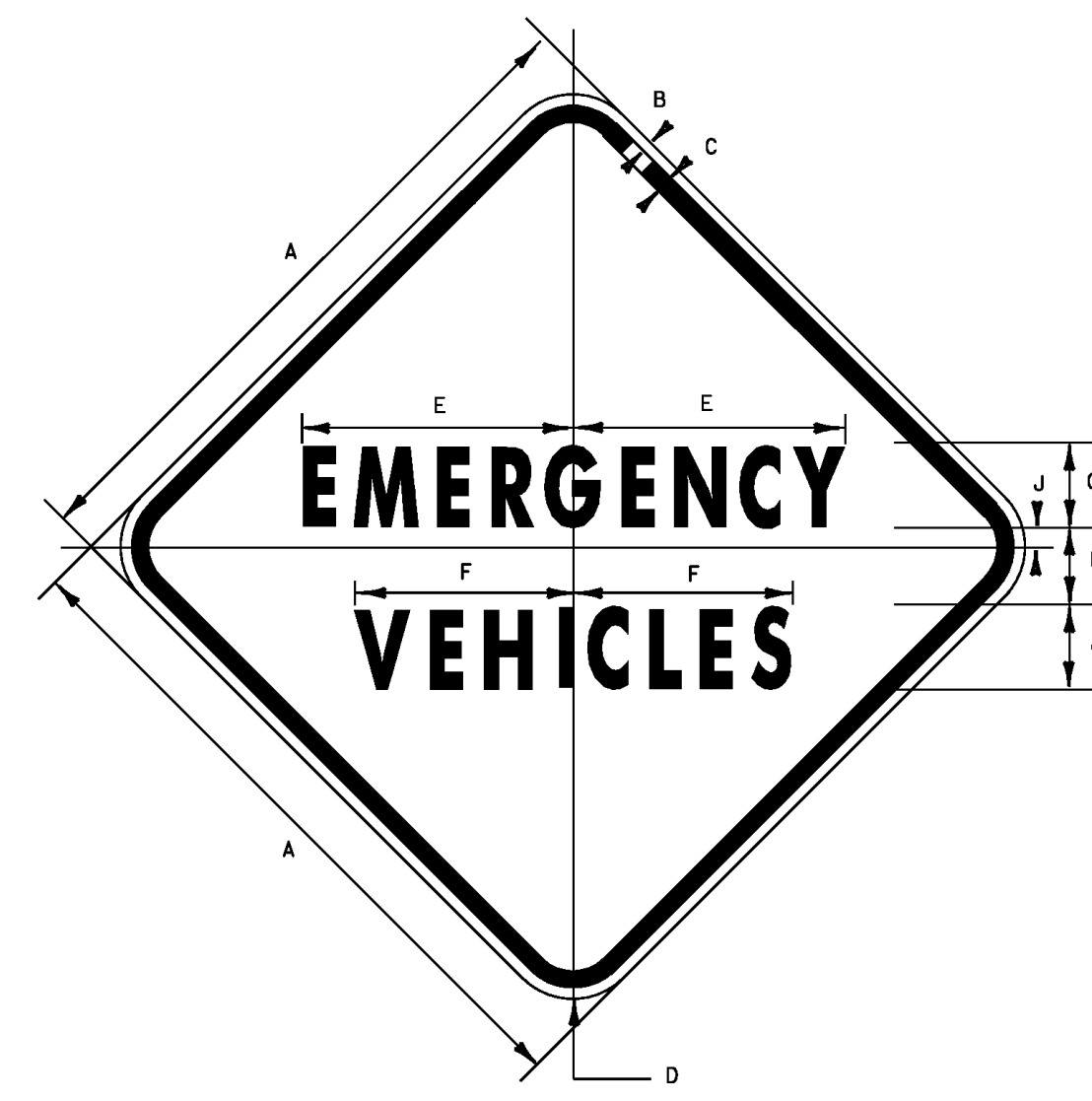

**VW-544**

\* LETTER SPACING REDUCED 50%

SIGN	DIMENSIONS ( INCHES )								
	A	B	C	D	E	F	G	H	J
MIN.	30	1/2	3/4	1 1/8	12 3/4	9 1/16	4C	3 3/8	7/8
STD.	36	5/8	7/8	2 1/4	14 3/8	11 5/8	5C	4	I
EXPWY.	48	3/4	1 1/4	3	19 1/8	15 1/8	6C	5 3/8	1 3/8

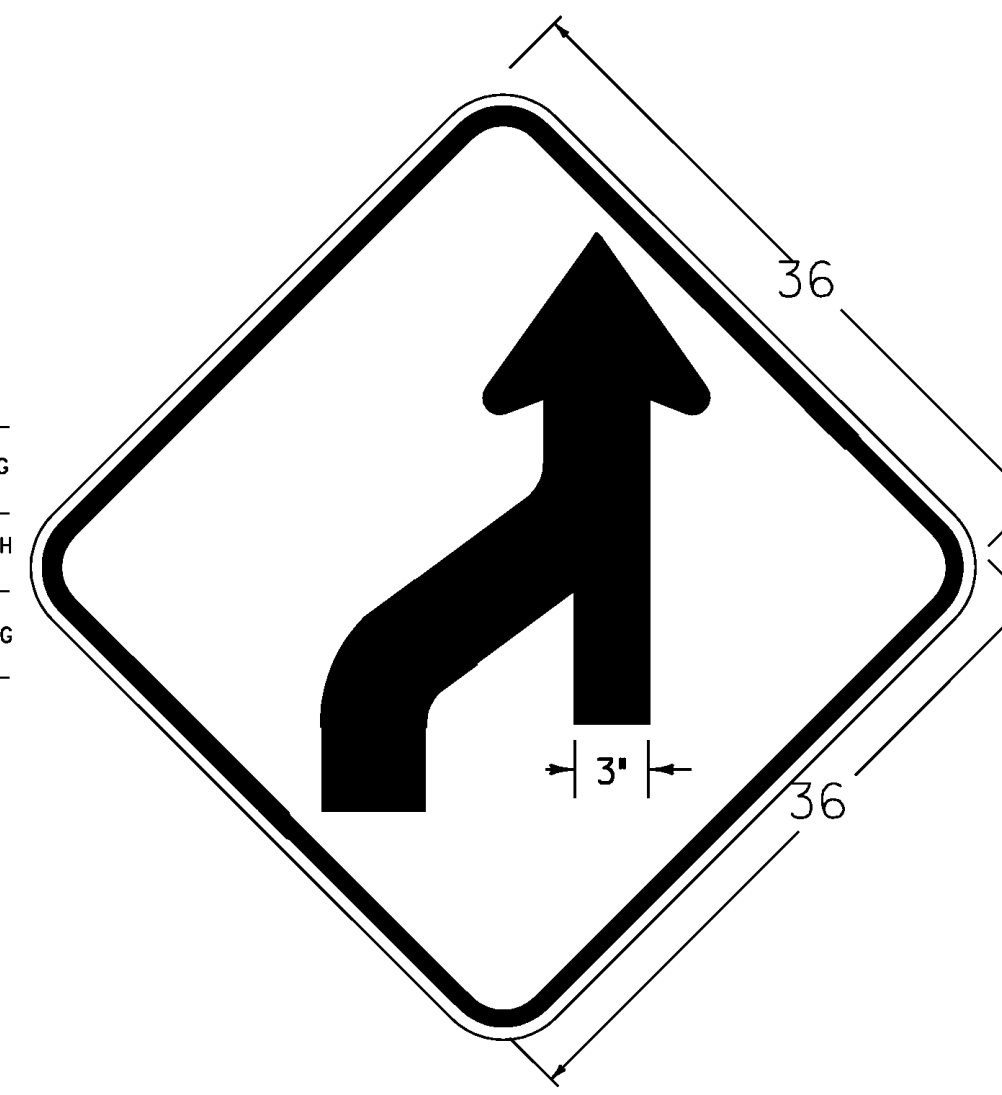

**W1-4MR**

DIMENSIONS NOT SHOWN FOR THIS DETAIL SHALL CONFORM TO THE LATEST EDITION OF THE 2009 MUTCD FOR SIGN DETAIL W1-4, UNLESS OTHERWISE NOTED FOR THIS DETAIL

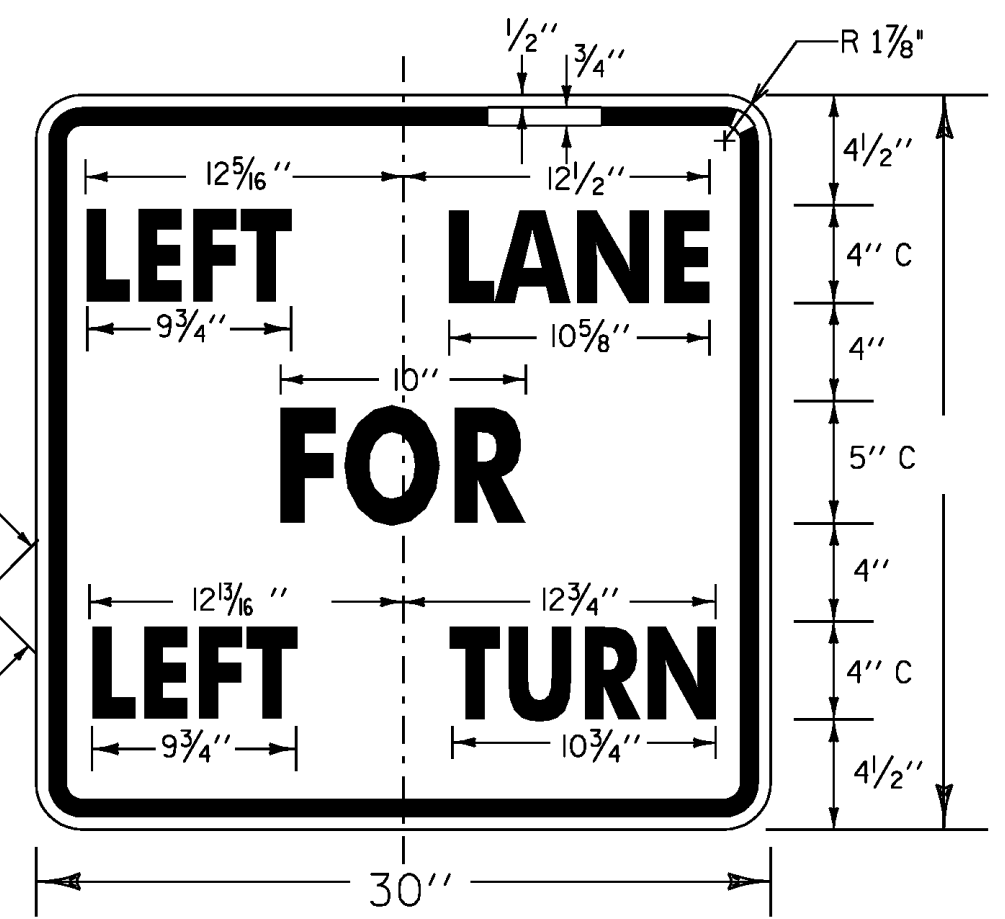

**VR-063L**

COLORS: LEGEND - BLACK BACKGROUND - WHITE

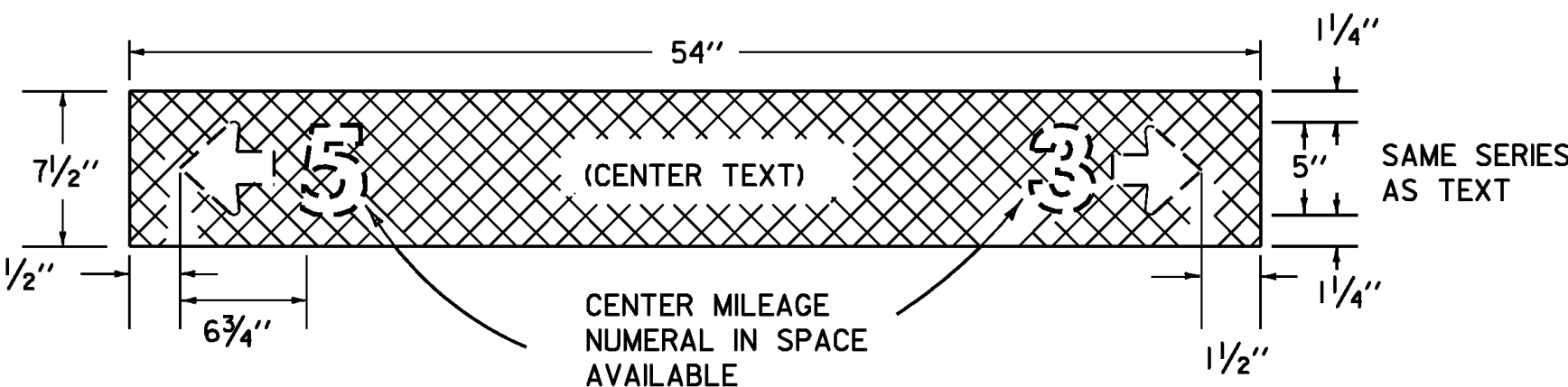

**SIGN & LEGEND LAYOUT DIMENSIONS**

VD-502

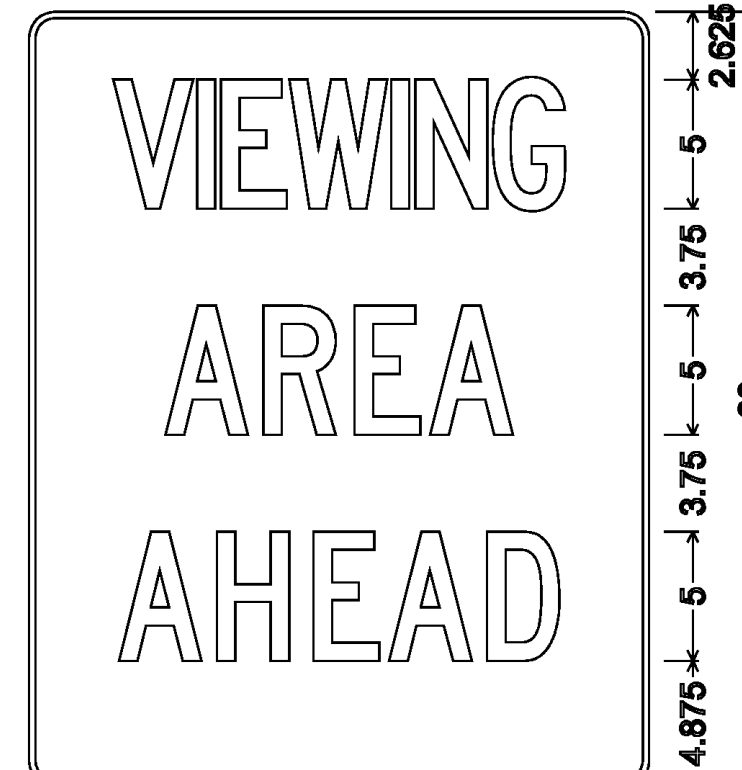

**D6-2M**

1.000" Radius, 0.250" Border, White on Blue; "VIEWING" C 2K specified length; "AREA" C 2K 85% spacing; "AHEAD" C 2K 85% spacing;

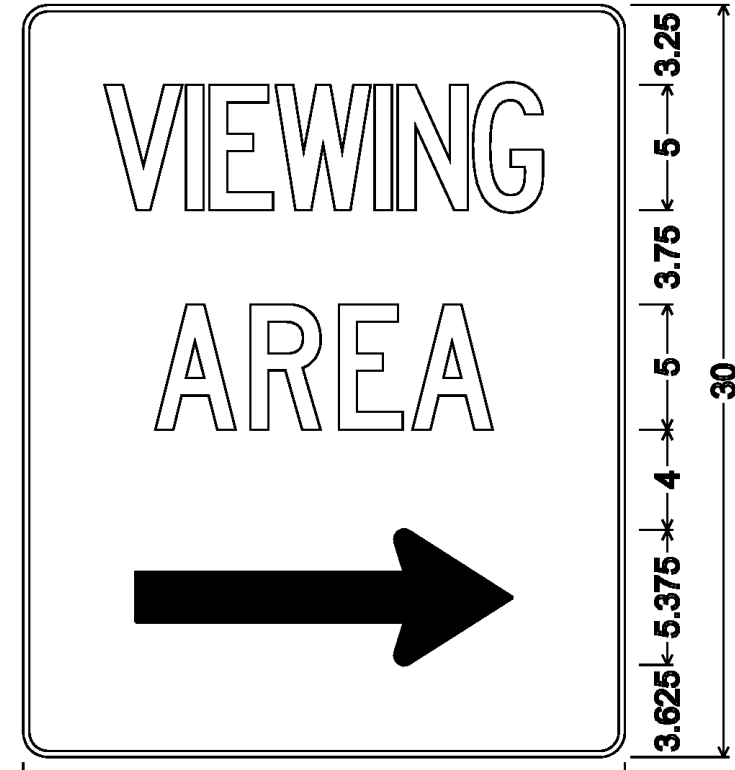

**D6-1M**

1.000" Radius, 0.250" Border, White on Blue; "VIEWING" C 2K specified length; "AREA" C 2K 85% spacing; Standard Arrow Custom 9.375" X 5.375" 0";

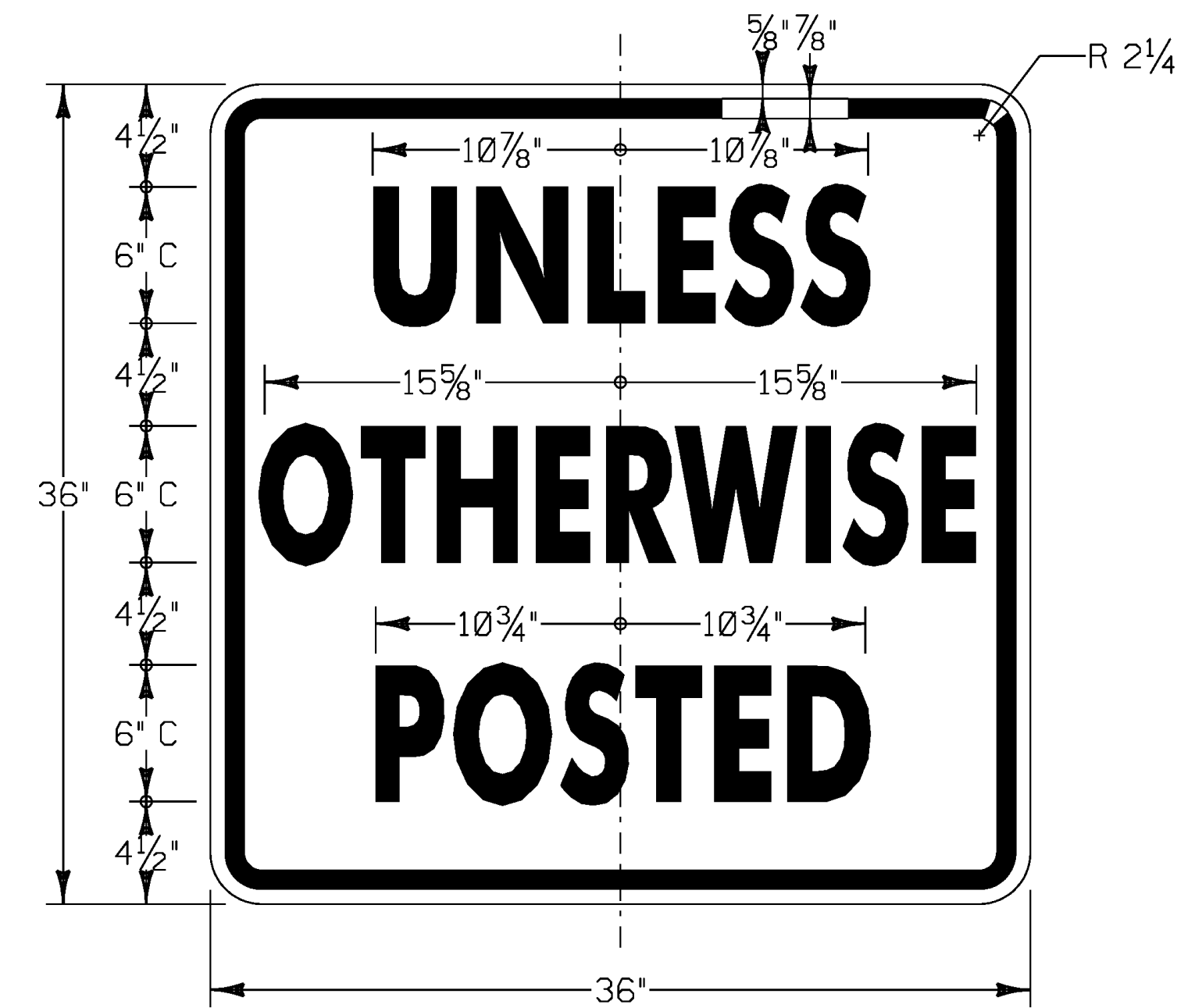

**VR-208**

COLORS: TEXT & BORDER = BLACK BACKGROUND = WHITE

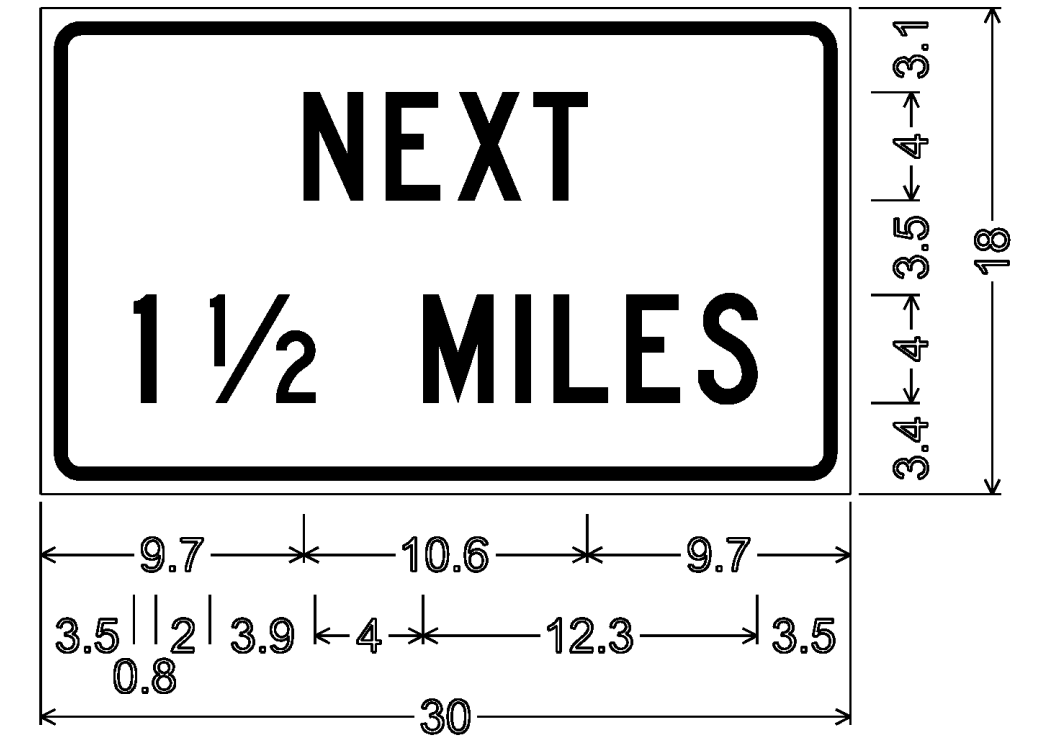

**W7-3a**

1.5" RADIUS, 0.5" BORDER, 0.5" INDENT COLORS: LEGEND - BLACK BACKGROUND - YELLOW TEXT STYLE: "NEXT" C; "1" C; "1/2 MILE" C

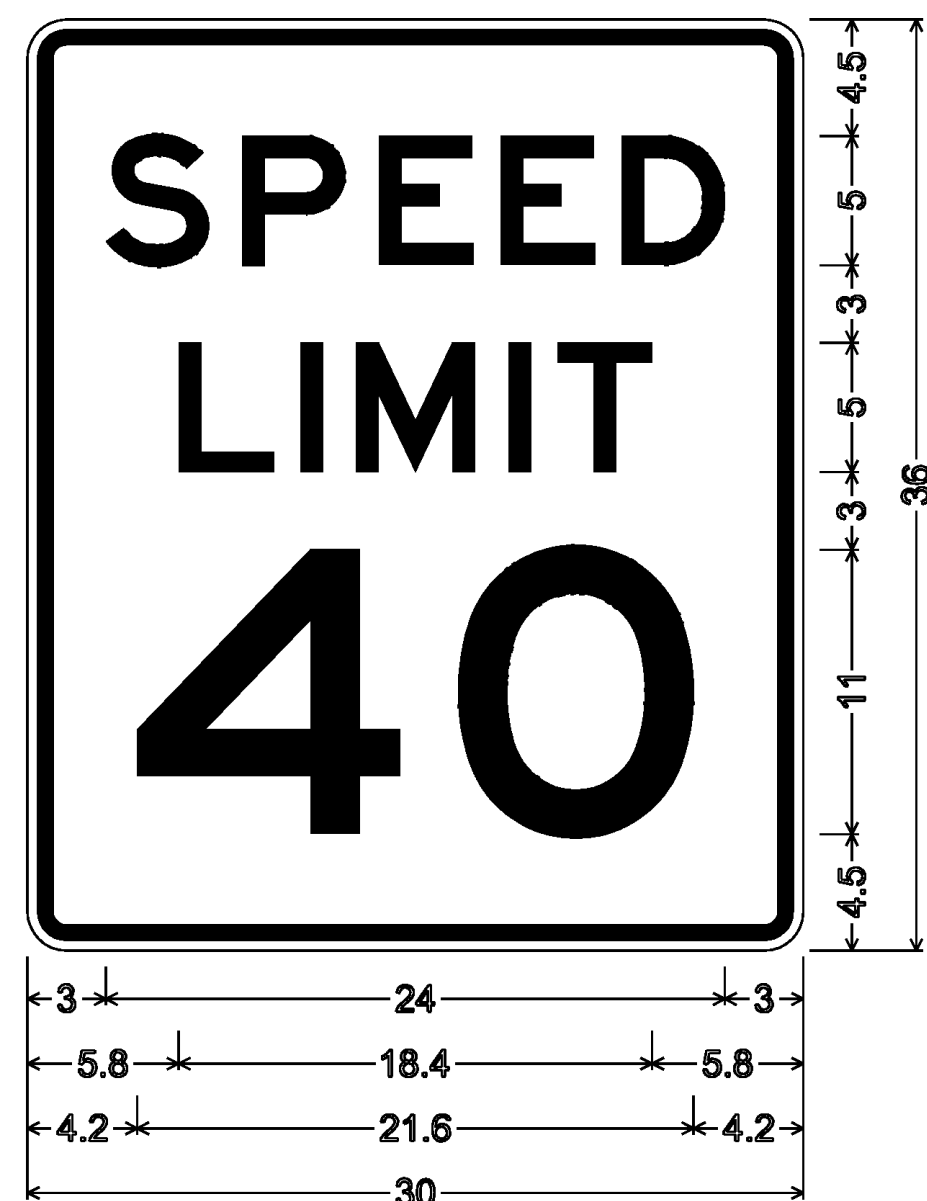

**R2-1**

1.5" RADIUS, 0.625" BORDER, 0.375" INDENT COLORS: LEGEND - BLACK BACKGROUND - WHITE TEXT STYLE: "SPEED" E; "LIMIT" E; "40" E

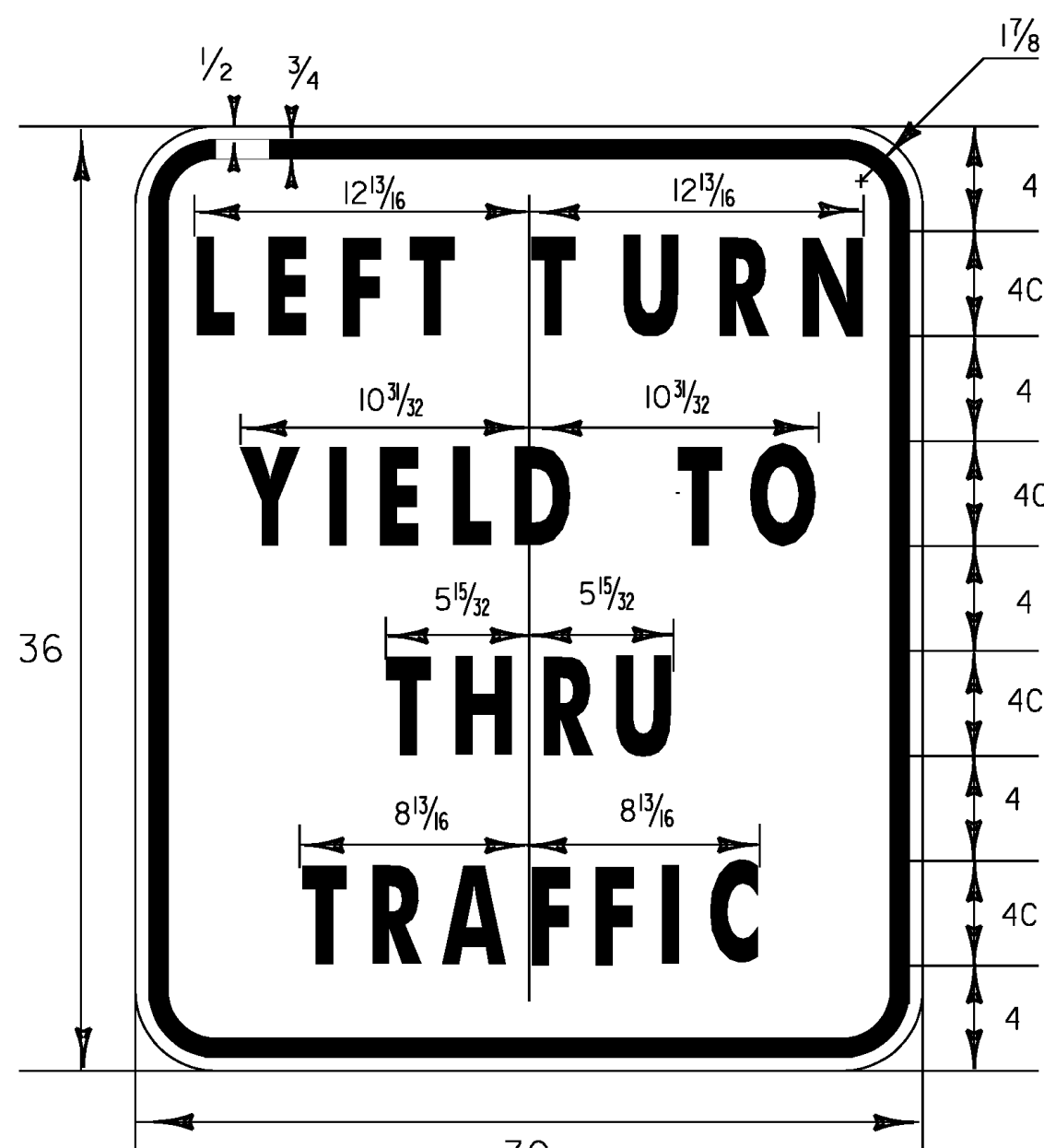

**VR-615**

COLORS: LEGEND - BLACK BACKGROUND - WHITE



**VR - 020**

COLORS: LEGEND - RED BACKGROUND - WHITE

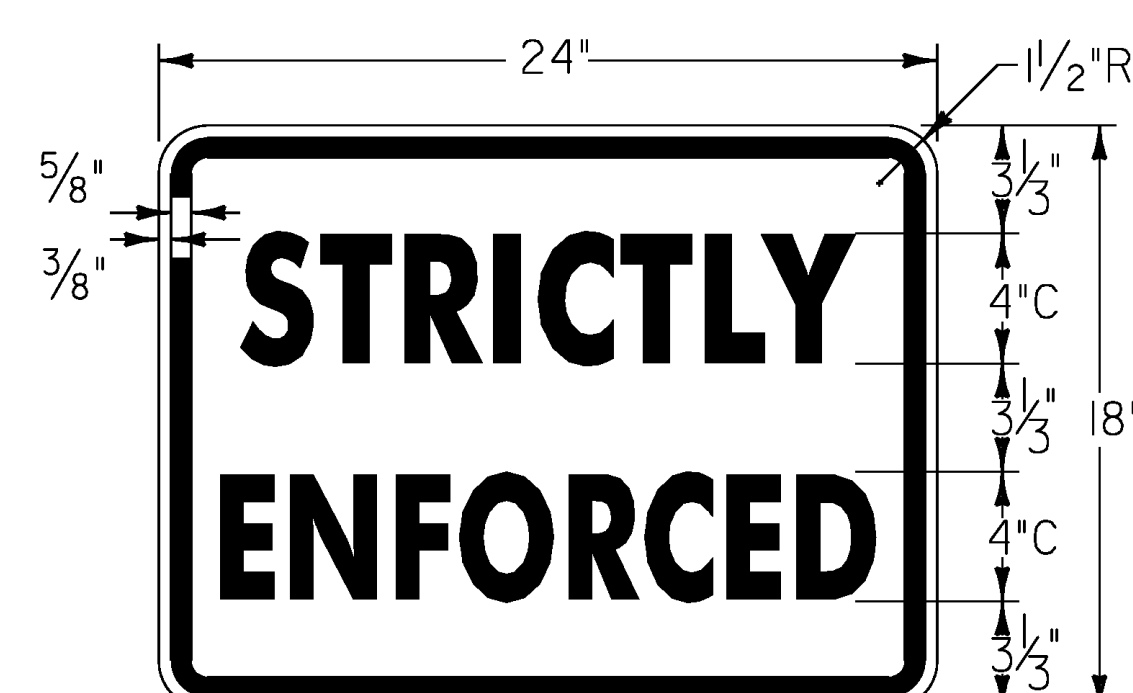

**VR-655**

\*REDUCE SPACING 50 %

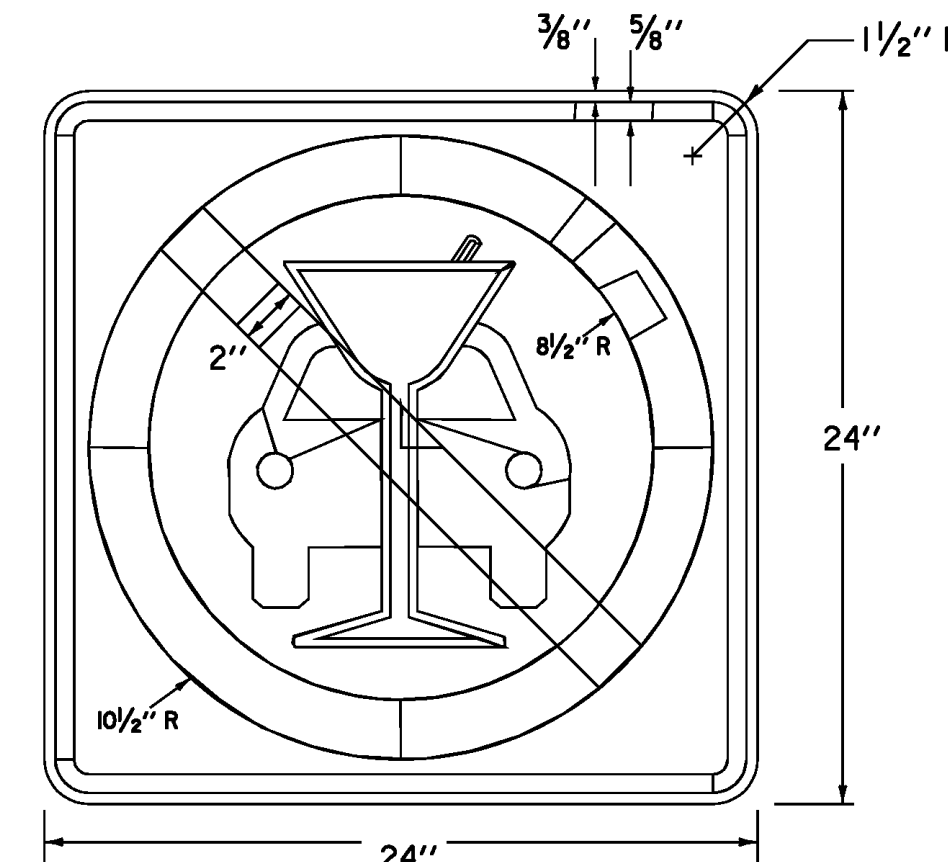

**VR-654**

COLORS: LEGEND - RED & BLACK BACKGROUND - WHITE

PROJECT NAME:	STATEWIDE - NORTHWEST REGION	FILE NAME:	10b008TS.DGN	PLOT DATE:	I2-AUG-2010
PROJECT NUMBER:	STPG SIGN (30)	PROJECT LEADER:	A. GAMBLE	DRAWN BY:	T. GUAZZONI
		DESIGNED BY:	T. GUAZZONI	CHECKED BY:	A. GAMBLE
		SIGN DETAILS 2		SHEET 6	OF 131