

VW-202

• REDUCE SPACING 10 %

SIGN	DIMENSIONS (INCHES)									
	A	B	C	D	E	F	G	H	I	J
MIN.	30	1/2	3/4	1 7/8	10 3/8	12 7/8	5C	5C	4	
STD.	36	5/8	7/8	2 1/4	12 1/2	13 1/4	6C	6C	4 3/8	
EXPWY.	48	3/4	1 1/4	3	20 1/2	15 3/8	8B	8B	6 3/8	

BLACK TEXT AND BORDER
YELLOW RETROREFLECTIVE BACKGROUND

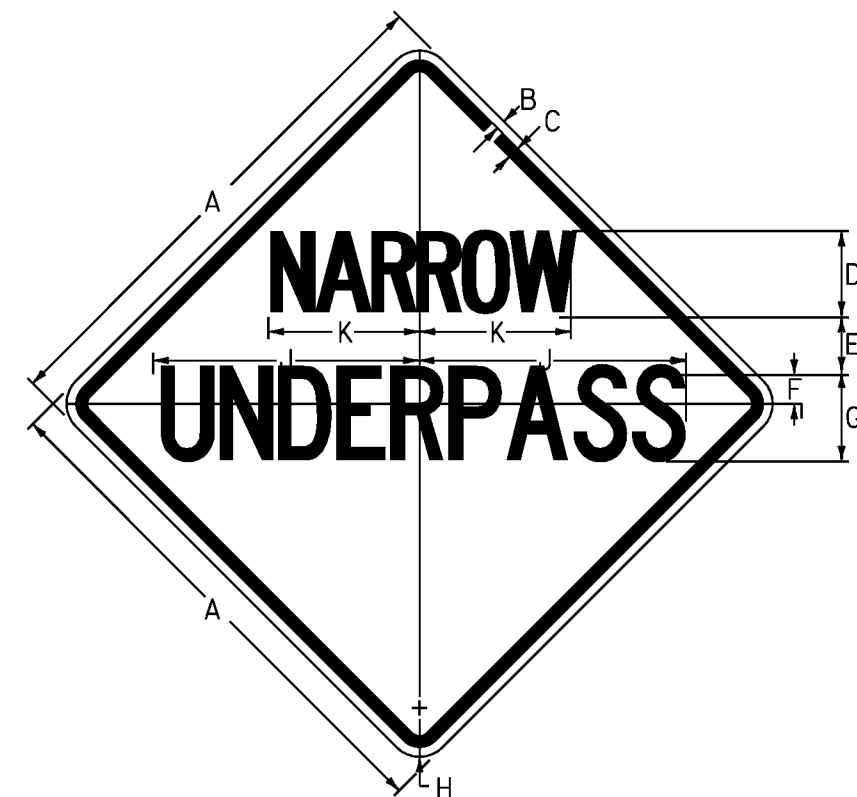

VW-268

SIGN	DIMENSIONS (INCHES)									
	A	B	C	D	E	F	G	H	I	J
MIN	30	3/8	5/8	3 3/4	1 1/4	5C	1 1/8	5 1/4	8 3/8	
STD	36	1/2	3/4	4	2	6C	2 1/4	8 1/2	10 1/2	

BLACK TEXT AND BORDER
YELLOW RETROREFLECTIVE BACKGROUND

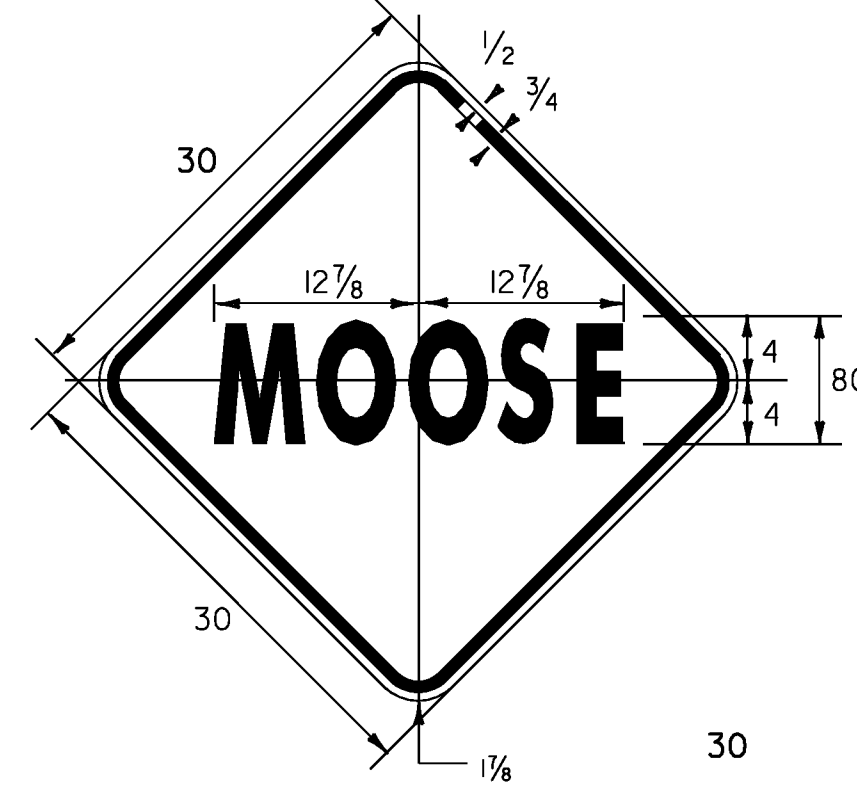

VW-001

BLACK TEXT AND BORDER
YELLOW RETROREFLECTIVE BACKGROUND

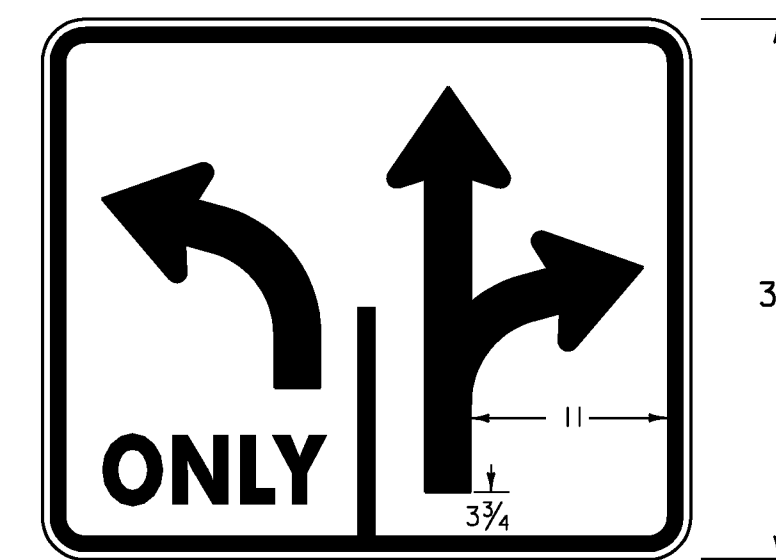

VR-922 L

SEE 2004 SHS FOR ADDITIONAL DIMENSIONS
BLACK TEXT AND BORDER
WHITE RETROREFLECTIVE BACKGROUND

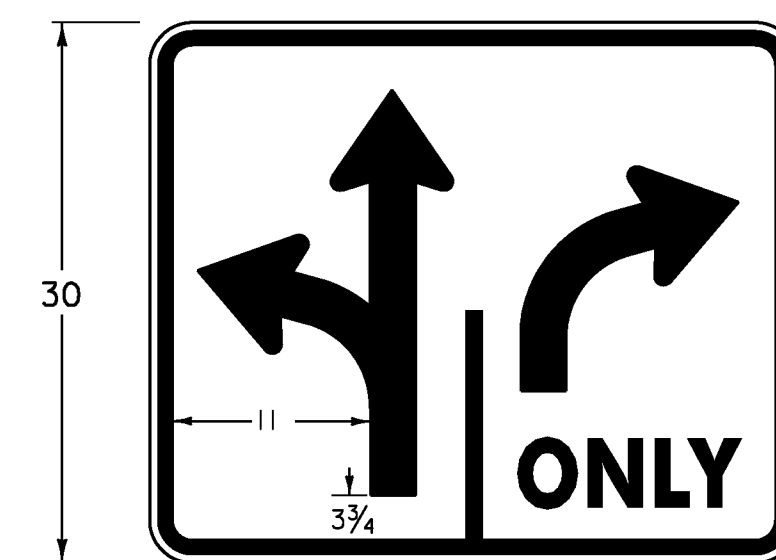

VR-922 R

SEE 2004 SHS FOR ADDITIONAL DIMENSIONS
BLACK TEXT AND BORDER
WHITE RETROREFLECTIVE BACKGROUND

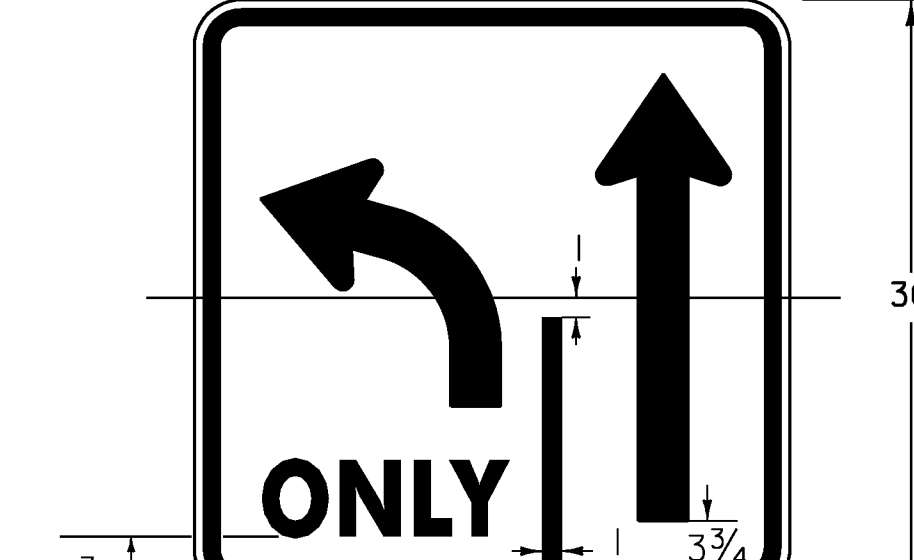

VR-921 L

SEE 2004 SHS FOR ADDITIONAL DIMENSIONS
BLACK TEXT AND BORDER
WHITE RETROREFLECTIVE BACKGROUND

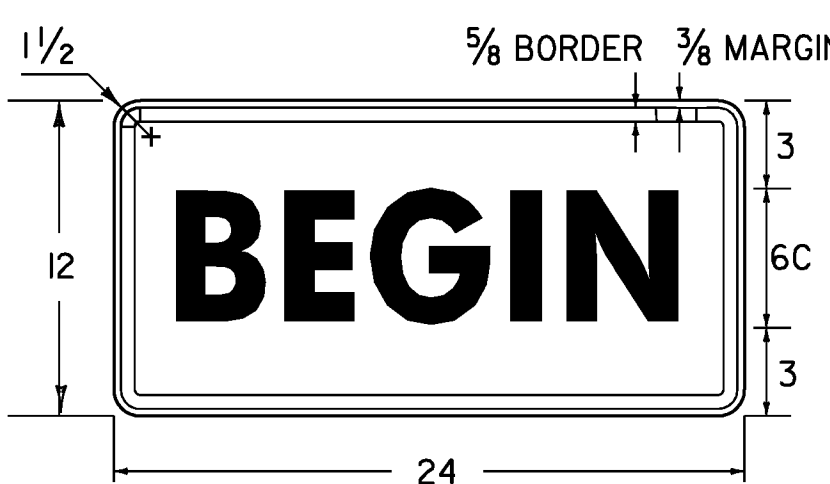

VR-644P

RED TEXT AND BORDER
WHITE RETROREFLECTIVE BACKGROUND

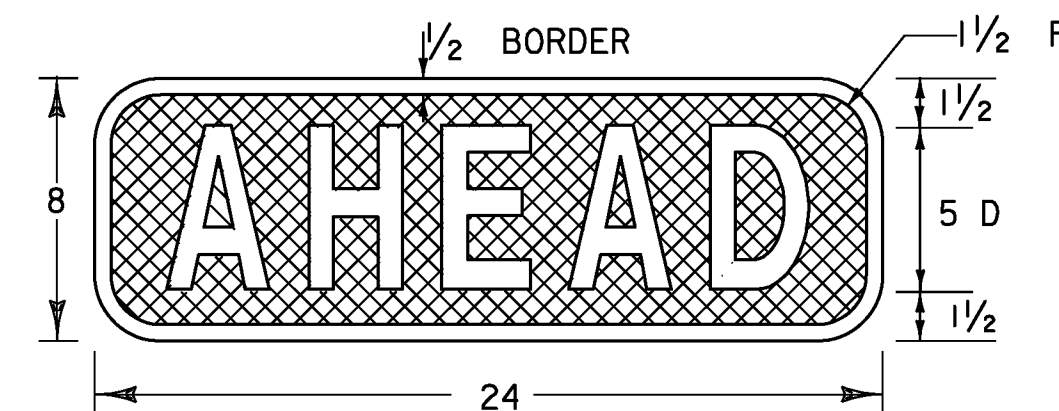

VD-058

WHITE RETROREFLECTIVE TEXT AND BORDER
BLUE RETROREFLECTIVE BACKGROUND

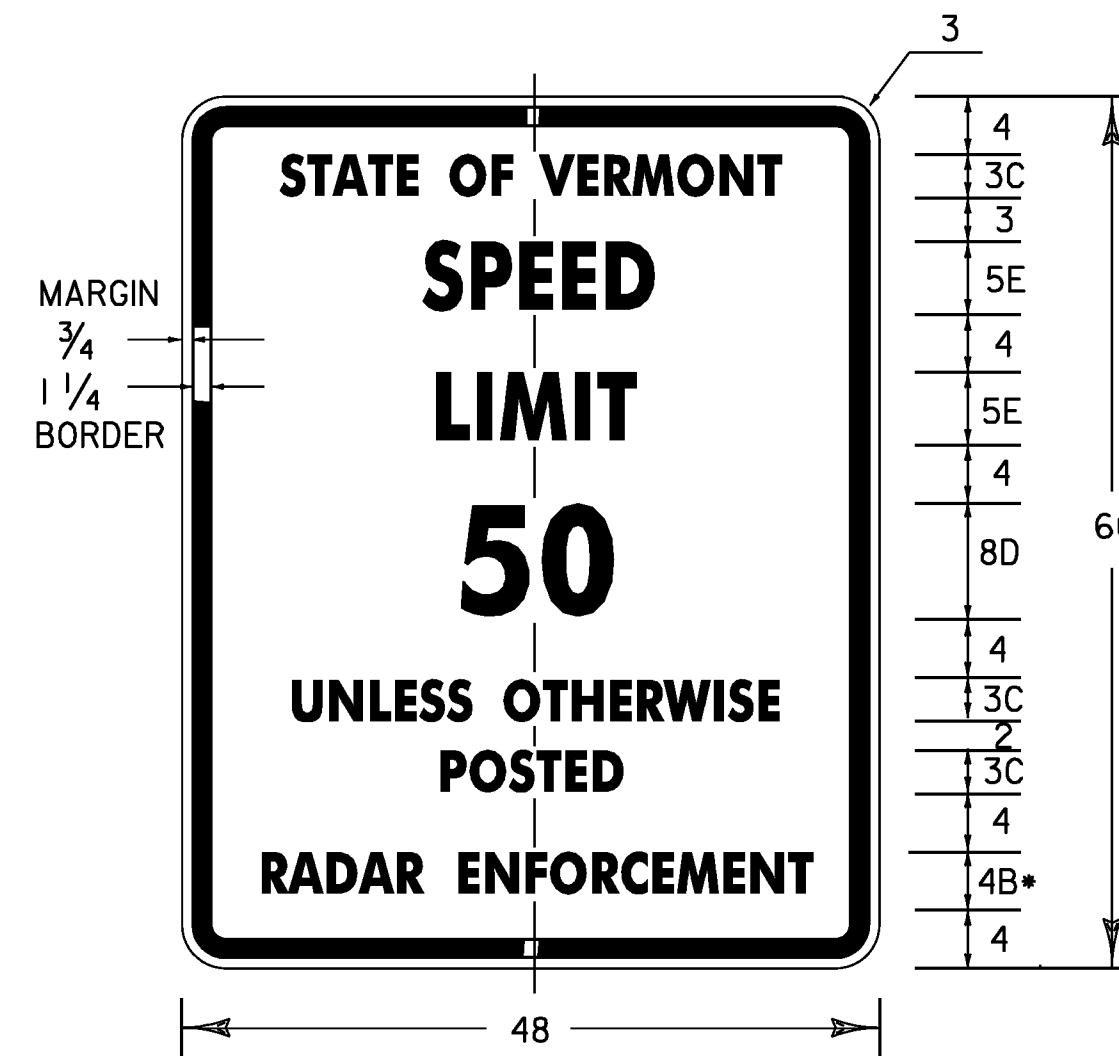

VR-114

BLACK TEXT AND BORDER
WHITE RETROREFLECTIVE BACKGROUND

• REDUCE SPACING 25%

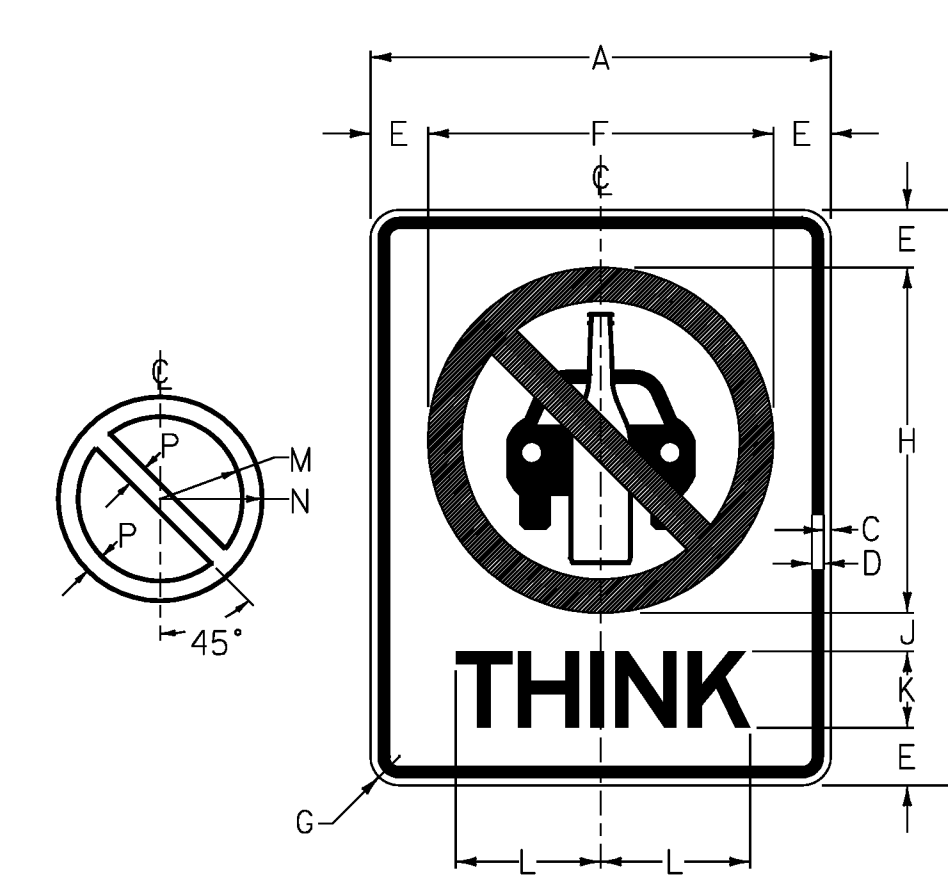

VR-072

SIGN	DIMENSIONS (INCHES)														
	A	B	C	D	E	F	G	H	I	J	K	L	M	N	P
STD.	24	30	3/8	5/8	3	18	1 1/2	18	2	4E	1 1/4	7	9	1 3/4	

COLORS
TEXT & BORDER - BLACK
CAR & BOTTLE SYMBOL - BLACK
PROHIBITED SYMBOL - RED
BACKGROUND - WHITE RETROREFLECTIVE

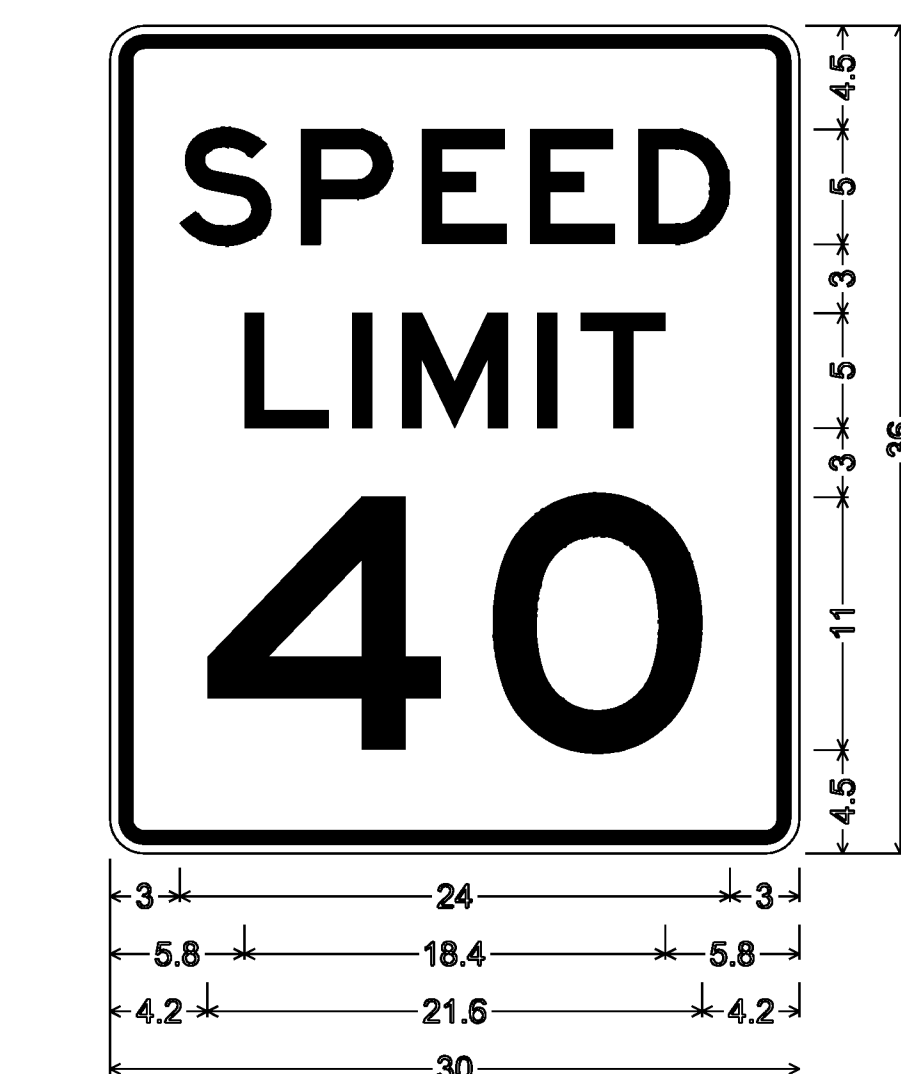

R2-1

1.5" RADIUS, 0.625" BORDER, 0.375" INDENT
COLORS: LEGEND - BLACK
BACKGROUND - WHITE RETROREFLECTIVE
TEXT STYLE: "SPEED" E; "LIMIT" E; "40" E

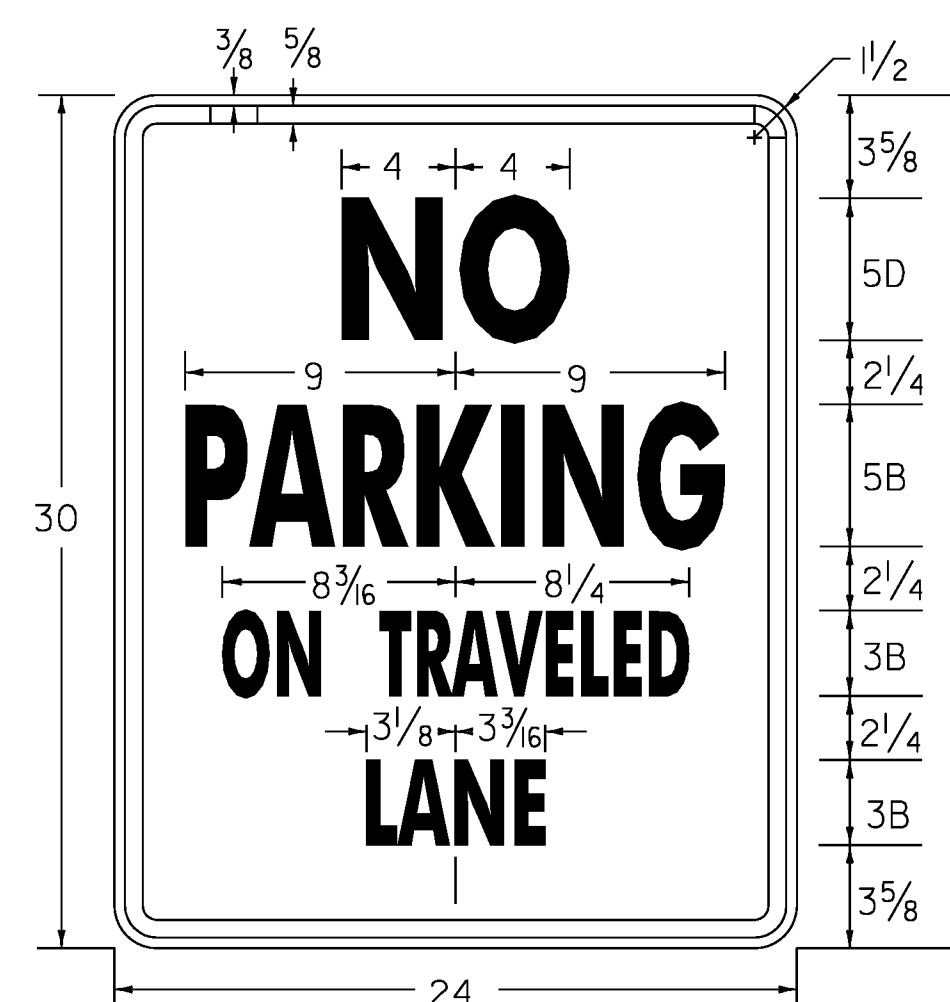

VR-020

COLORS
LEGEND - RED
BACKGROUND - WHITE RETROREFLECTIVE

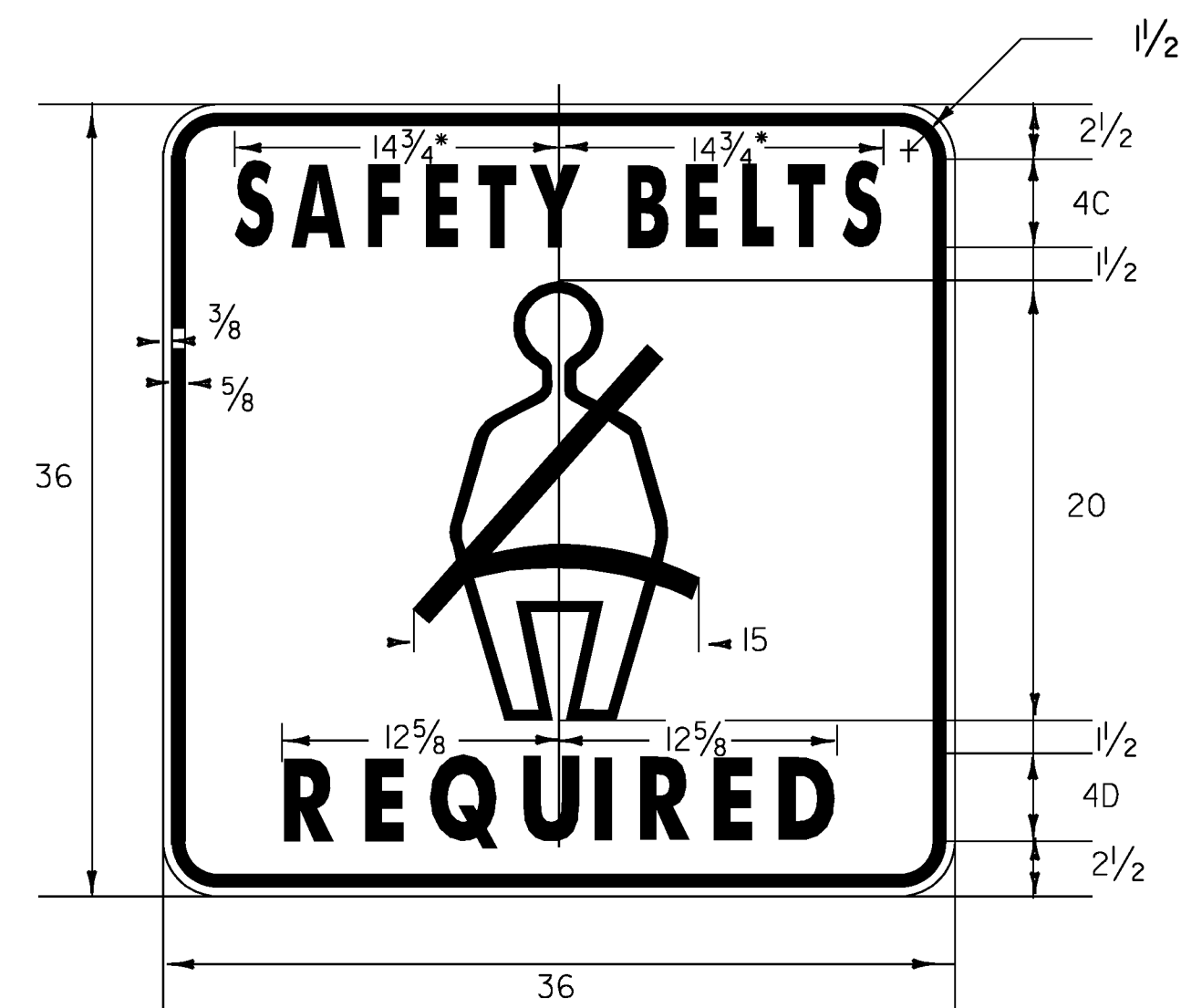

VR-601

•REDUCE SPACING 50%
BLACK TEXT AND BORDER
WHITE RETROREFLECTIVE BACKGROUND

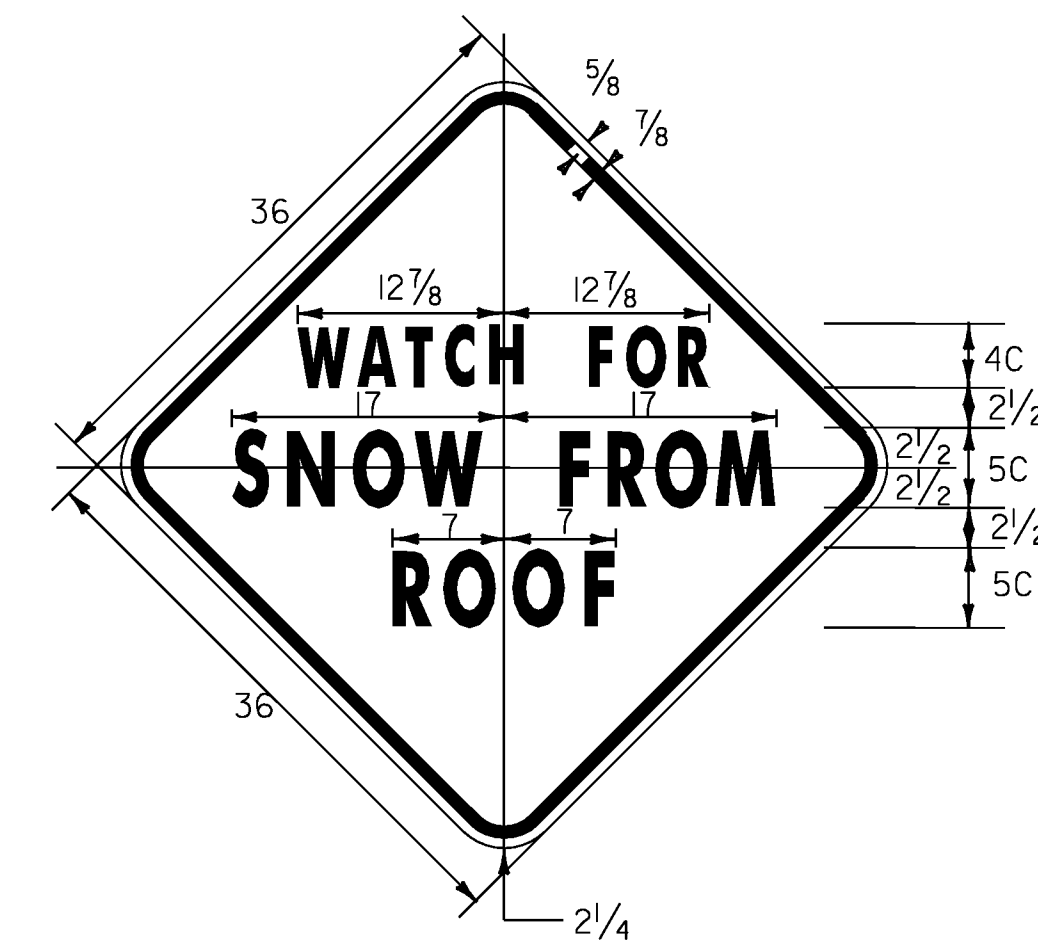
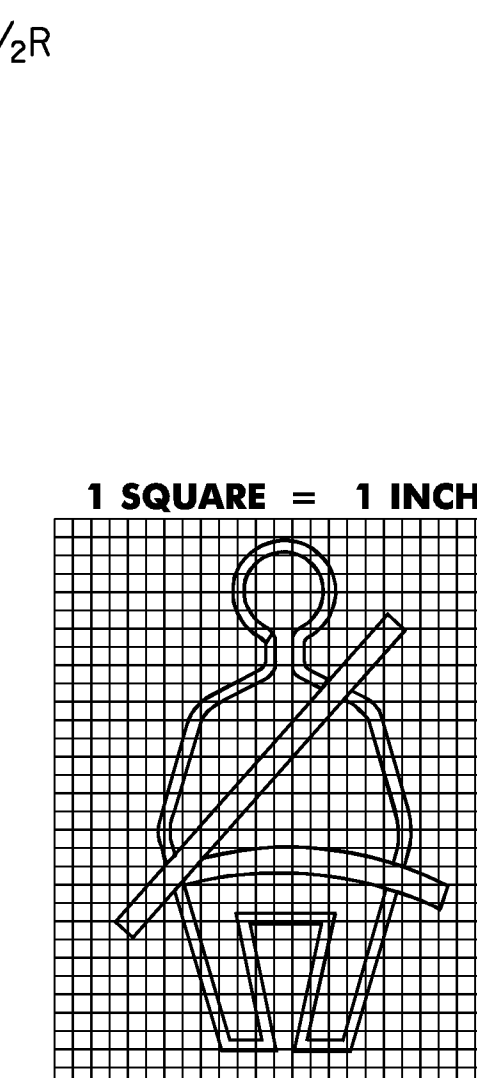

VW-542

BLACK TEXT AND BORDER
YELLOW RETROREFLECTIVE BACKGROUND

ALL DIMENSIONS SHOWN IN INCHES UNLESS OTHERWISE NOTED.

PROJECT NAME: STATEWIDE NORTHEAST

PROJECT NUMBER: STPG SIGN (29)

FILE NAME: I08006.SD
PROJECT LEADER: A. GAMBLE
DESIGNED BY: D.CROSSLEY
SIGN DETAILS 3

PLOT DATE: 24-AUG-2010
DRAWN BY: D.CROSSLEY
CHECKED BY: A. GAMBLE
SHEET 6 OF 138