

W1-1Md L(R)

DIMENSIONS NOT SHOWN FOR THIS DETAIL SHALL CONFORM TO THE LATEST EDITION OF THE 2003 MUTCD FOR SIGN DETAIL W1-1, UNLESS OTHERWISE NOTED FOR THIS DETAIL

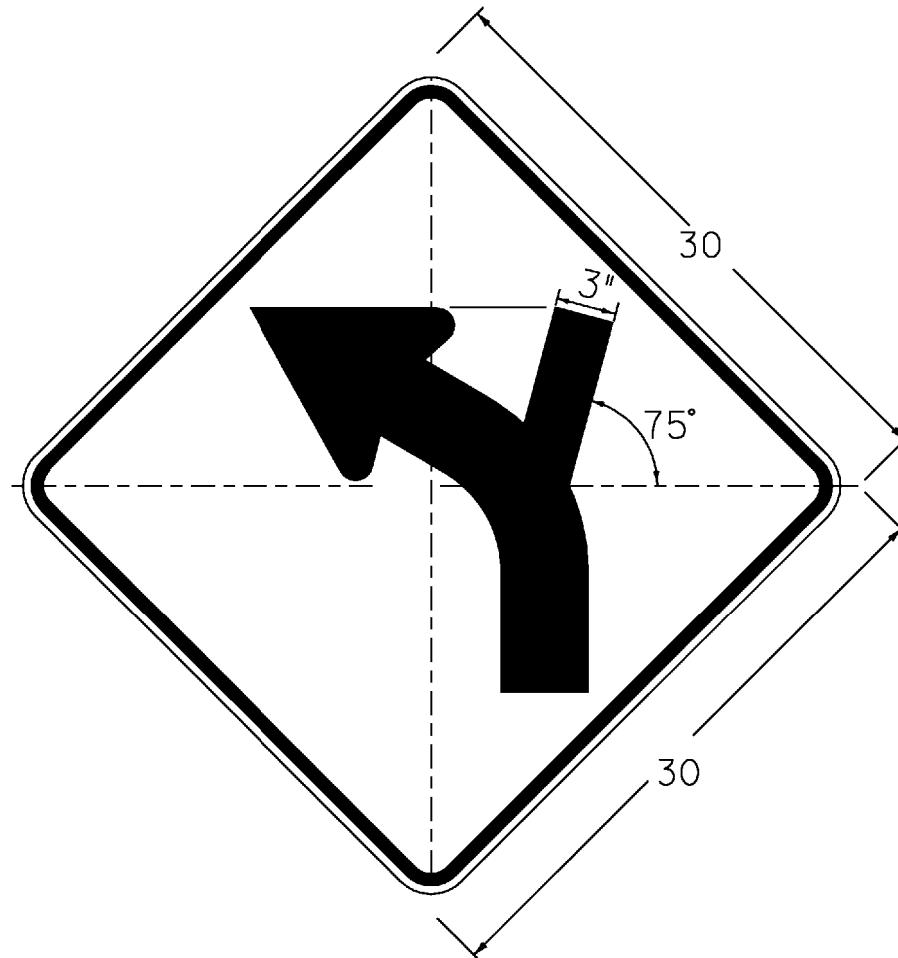

W1-2Mi L(R)

DIMENSIONS NOT SHOWN FOR THIS DETAIL SHALL CONFORM TO THE LATEST EDITION OF THE 2003 MUTCD FOR SIGN DETAIL W1-2, UNLESS OTHERWISE NOTED FOR THIS DETAIL

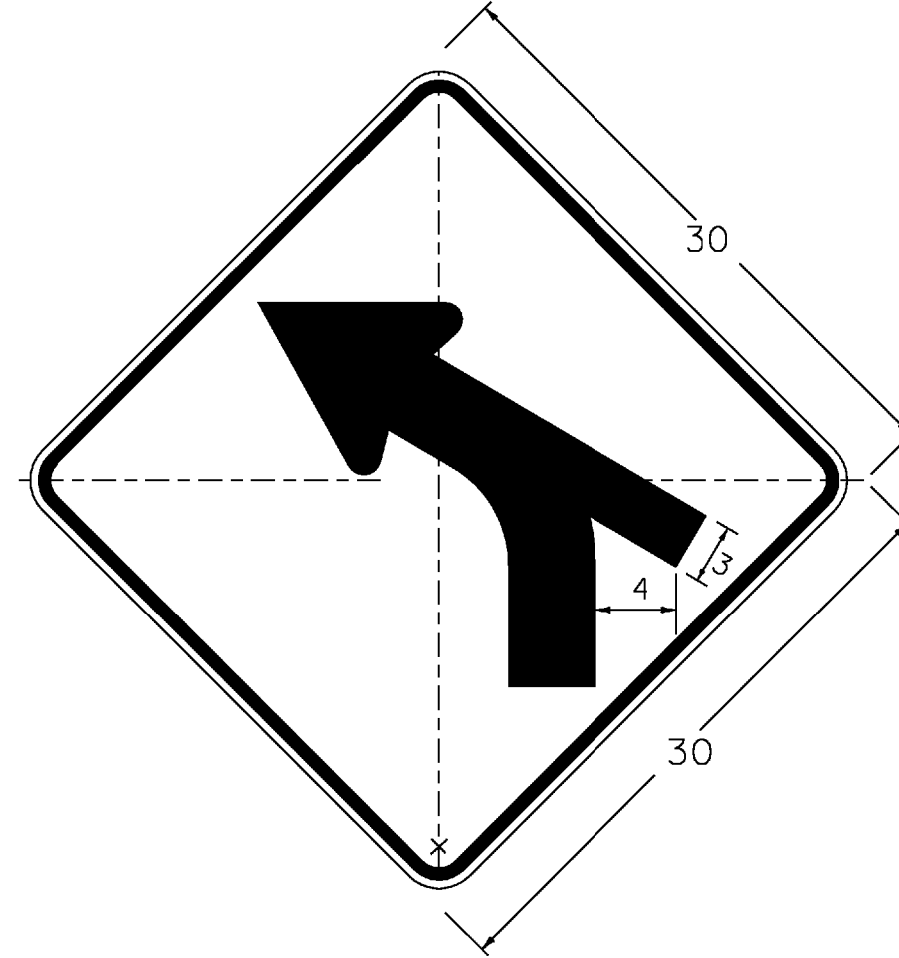

W1-2Mh L(R)

DIMENSIONS NOT SHOWN FOR THIS DETAIL SHALL CONFORM TO THE LATEST EDITION OF THE 2003 MUTCD FOR SIGN DETAIL W1-2, UNLESS OTHERWISE NOTED FOR THIS DETAIL

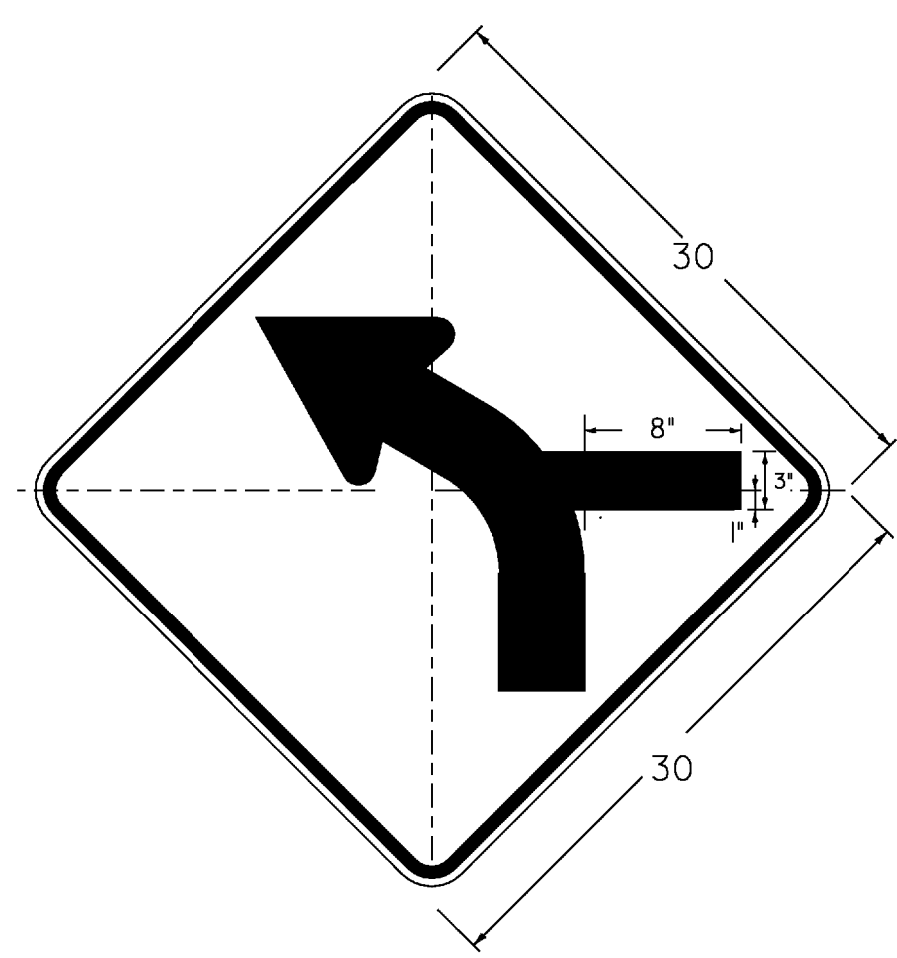

W1-2Mc L

DIMENSIONS NOT SHOWN FOR THIS DETAIL SHALL CONFORM TO THE LATEST EDITION OF THE 2003 MUTCD FOR SIGN DETAIL W1-2, UNLESS OTHERWISE NOTED FOR THIS DETAIL

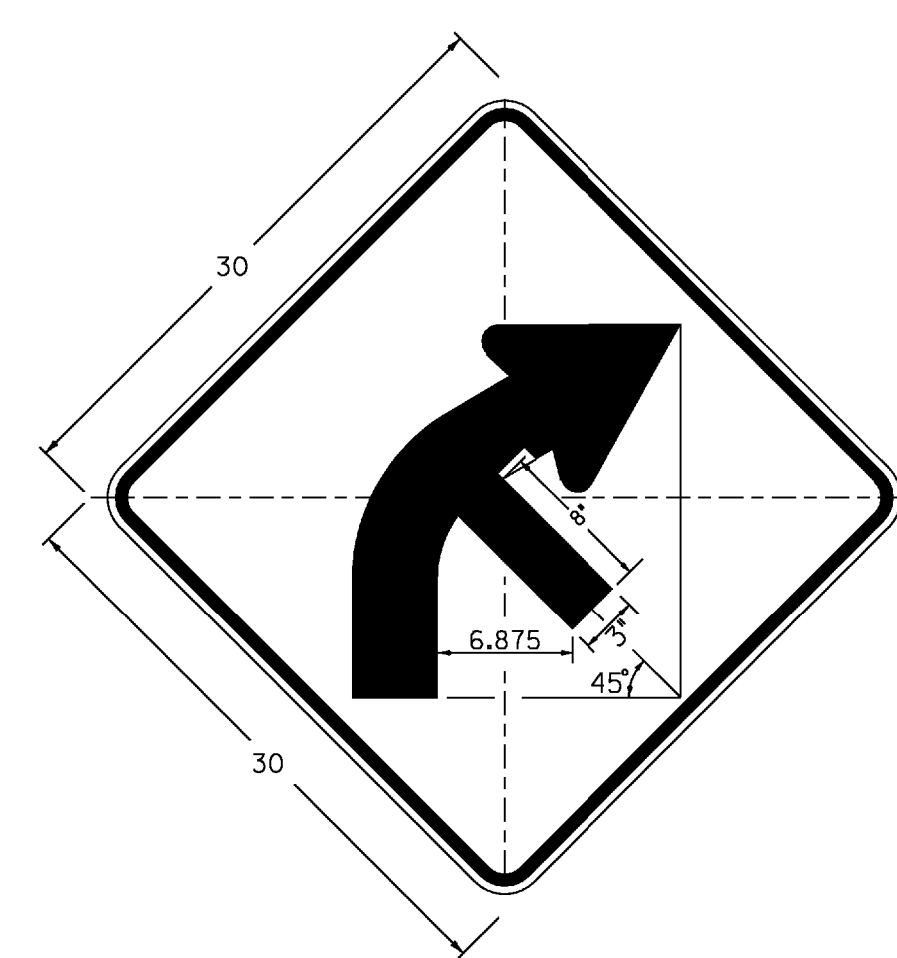

W1-2Mb R(L)

DIMENSIONS NOT SHOWN FOR THIS DETAIL SHALL CONFORM TO THE LATEST EDITION OF THE 2003 MUTCD FOR SIGN DETAIL W1-2, UNLESS OTHERWISE NOTED FOR THIS DETAIL

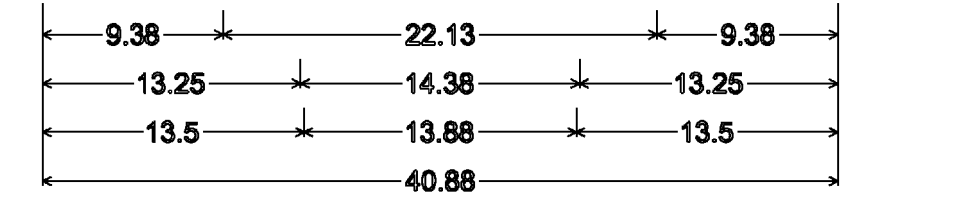
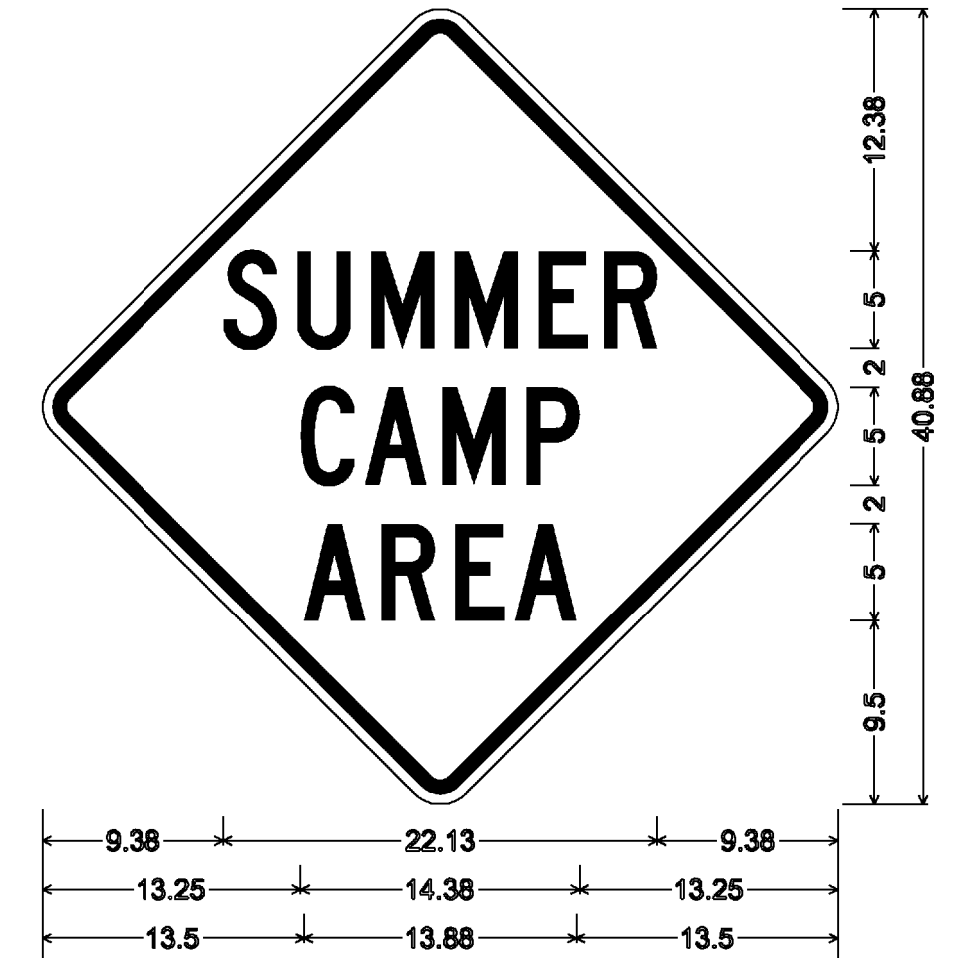

1.875" RADIUS, 0.75" BORDER, 0.5" INDENT
 COLORS: LEGEND - BLACK
 BACKGROUND - YELLOW
 TEXT STYLE: "SUMMER" C; "CAMP" C; "AHEAD" C

VW-219

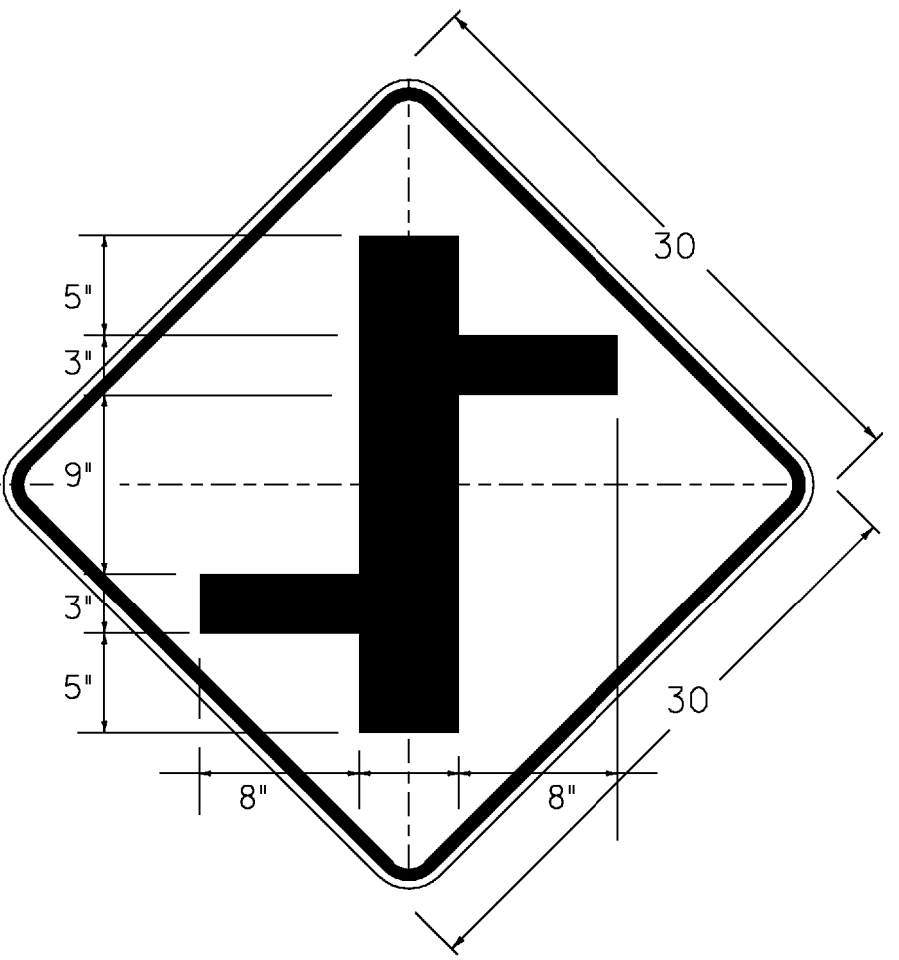

W2-1Me

DIMENSIONS NOT SHOWN FOR THIS DETAIL SHALL CONFORM TO THE LATEST EDITION OF THE 2003 MUTCD FOR SIGN DETAIL W2-1, UNLESS OTHERWISE NOTED FOR THIS DETAIL

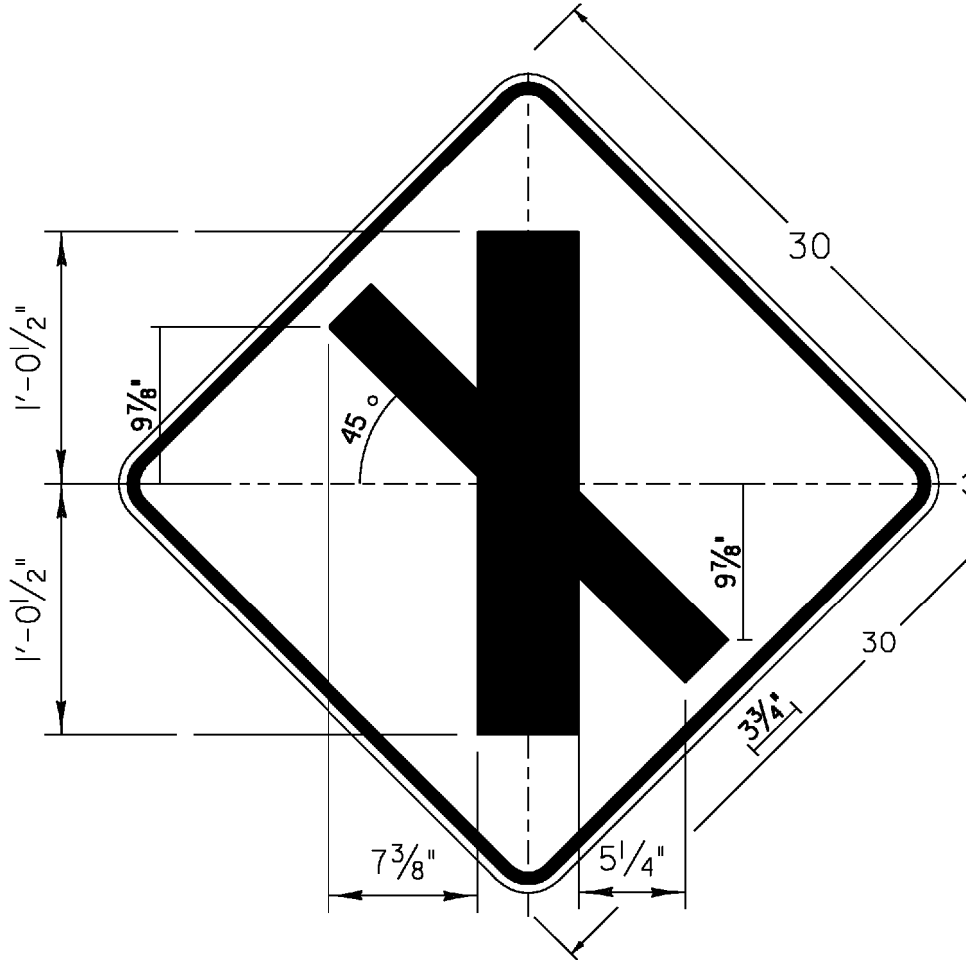

W2-1Mh

DIMENSIONS NOT SHOWN FOR THIS DETAIL SHALL CONFORM TO THE LATEST EDITION OF THE 2003 MUTCD FOR SIGN DETAIL W2-1, UNLESS OTHERWISE NOTED FOR THIS DETAIL

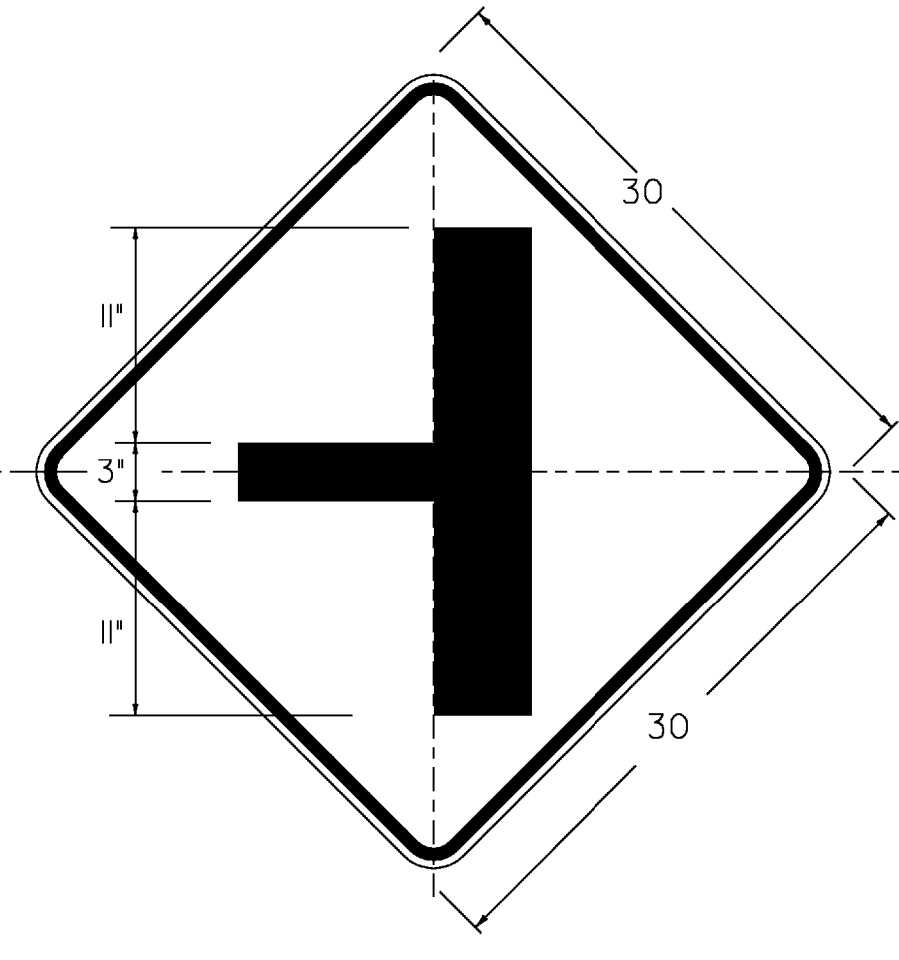

W2-2Ma L(R)

DIMENSIONS NOT SHOWN FOR THIS DETAIL SHALL CONFORM TO THE LATEST EDITION OF THE 2003 MUTCD FOR SIGN DETAIL W2-2, UNLESS OTHERWISE NOTED FOR THIS DETAIL

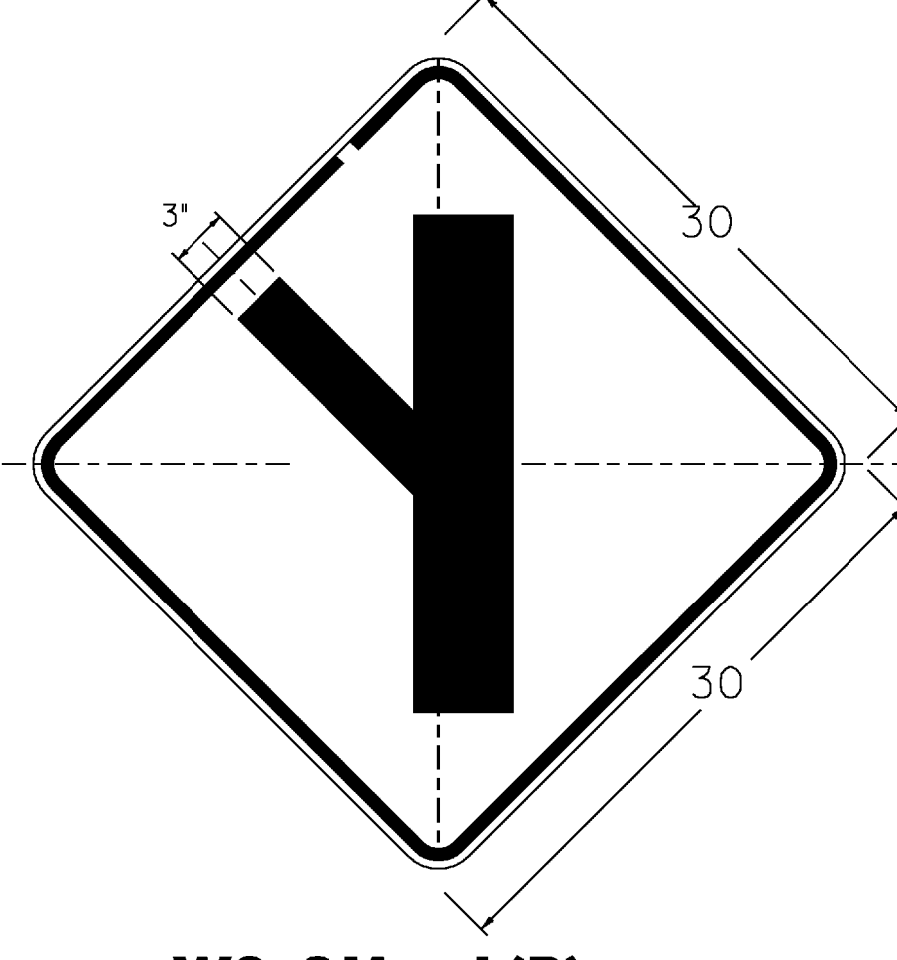

W2-3Ma L(R)

DIMENSIONS NOT SHOWN FOR THIS DETAIL SHALL CONFORM TO THE LATEST EDITION OF THE 2003 MUTCD FOR SIGN DETAIL W2-3, UNLESS OTHERWISE NOTED FOR THIS DETAIL

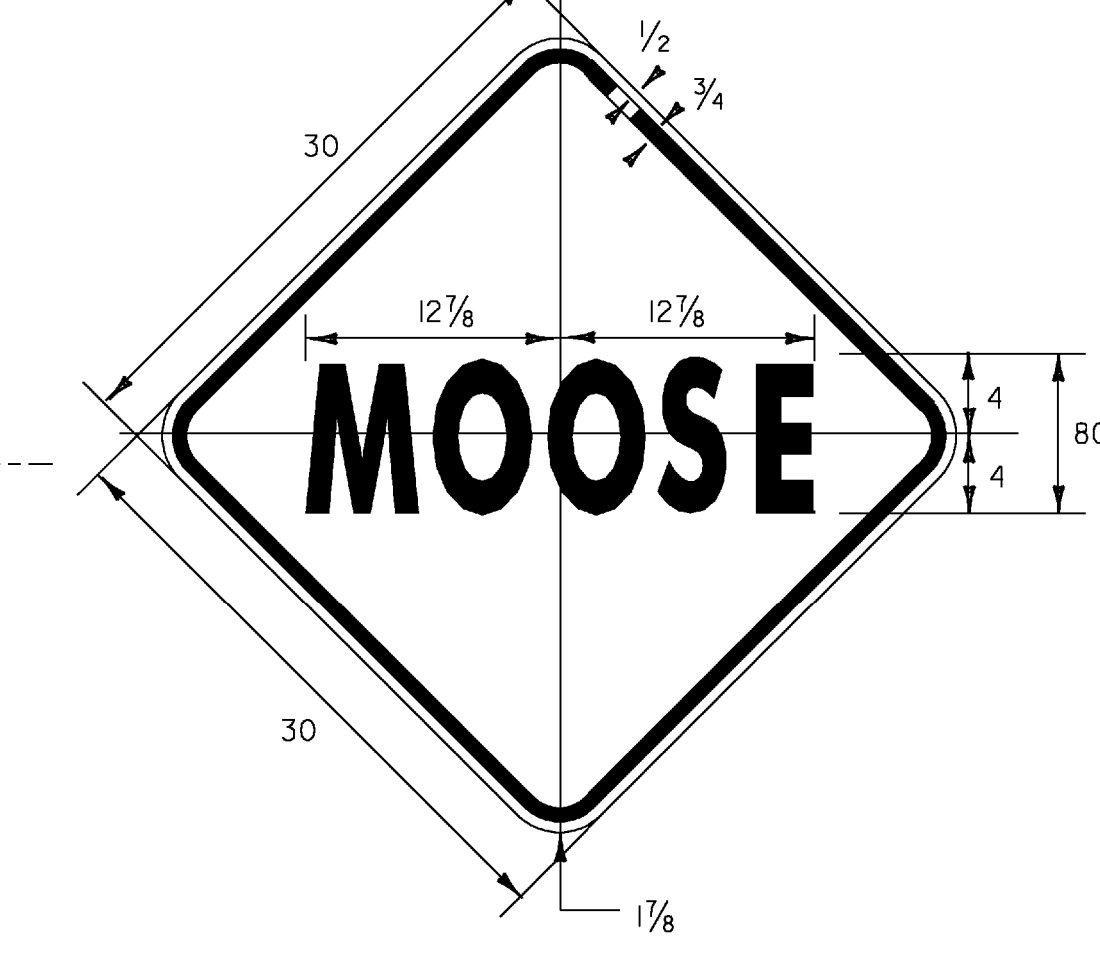

VW-001

COLORS: LEGEND - BLACK
 BACKGROUND - YELLOW



1.5" RADIUS, 0.625" BORDER, 0.375" INDENT
 COLORS: LEGEND - RED
 BACKGROUND - WHITE
 TEXT STYLE: "BEGIN" C

VR-644p

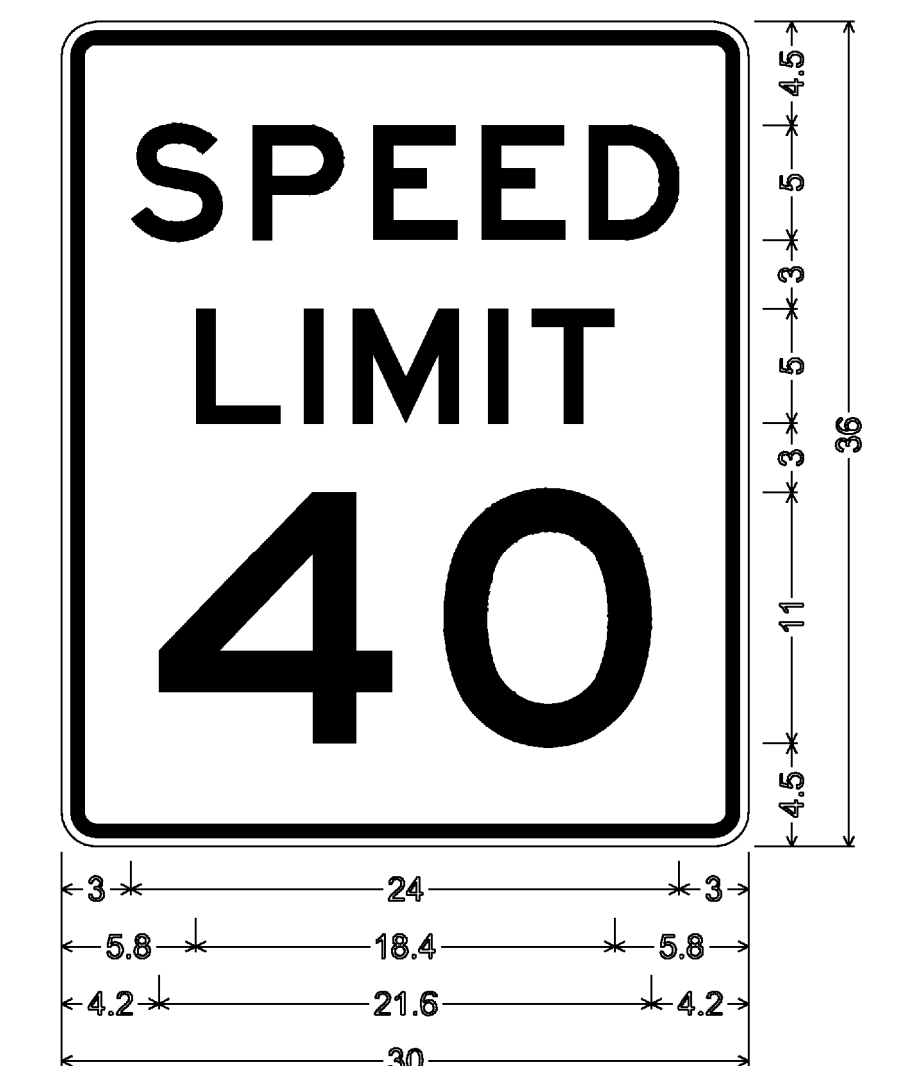

R2-1

1.5" RADIUS, 0.625" BORDER, 0.375" INDENT
 COLORS: LEGEND - BLACK
 BACKGROUND - WHITE
 TEXT STYLE: "SPEED" E; "LIMIT" E; "40" E

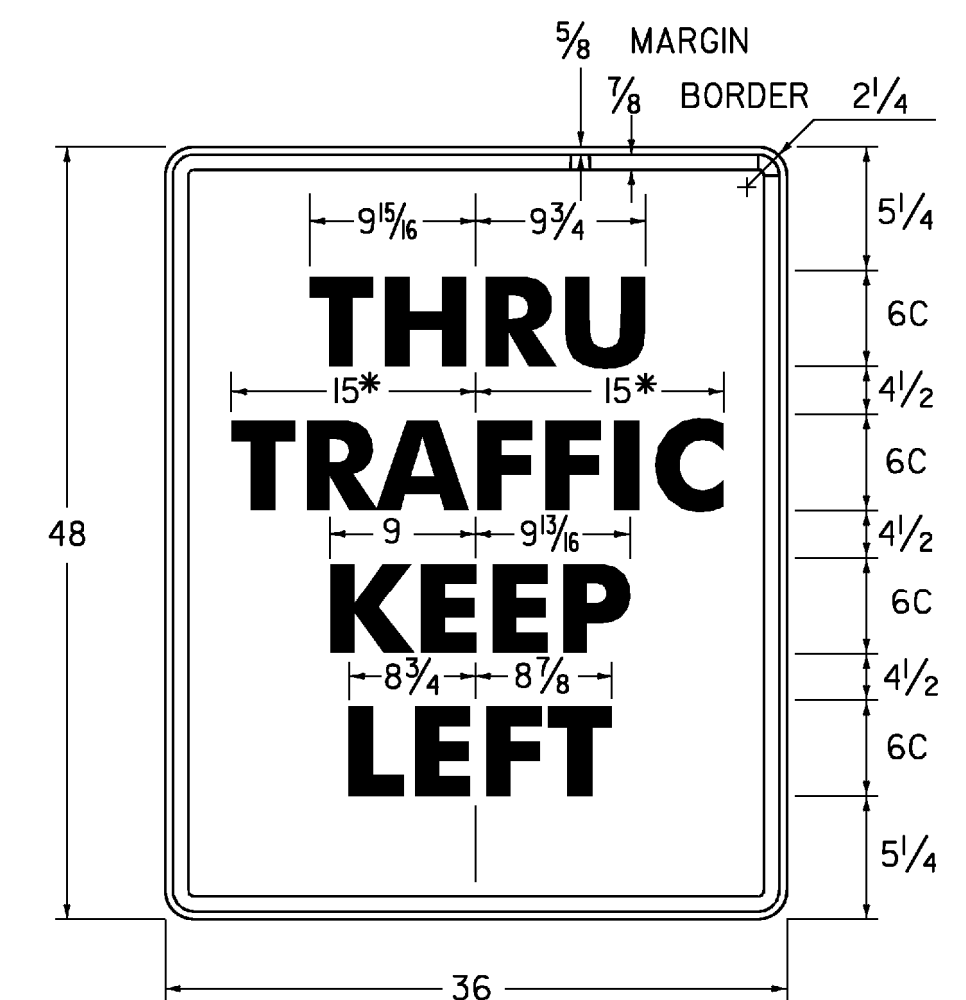

VR-118L

* REDUCE SPACING 25 %
 COLORS: LEGEND - BLACK
 BACKGROUND - WHITE

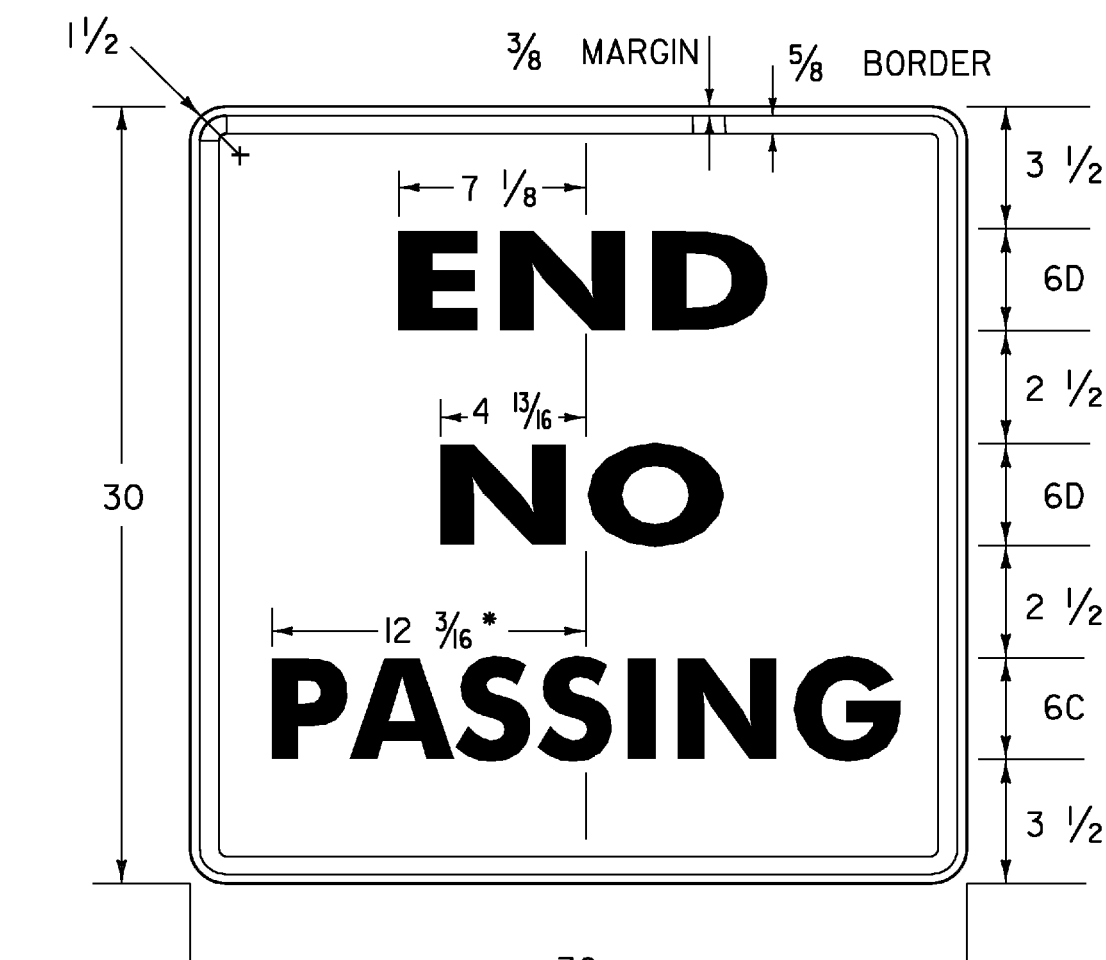

VR-417

* REDUCE SPACING 50 %
 COLORS: LEGEND - BLACK
 BACKGROUND - WHITE



VR-023b

* REDUCE SPACING 40%
 ** REDUCE SPACING 60%
 COLORS: LEGEND - BLACK
 BACKGROUND - WHITE

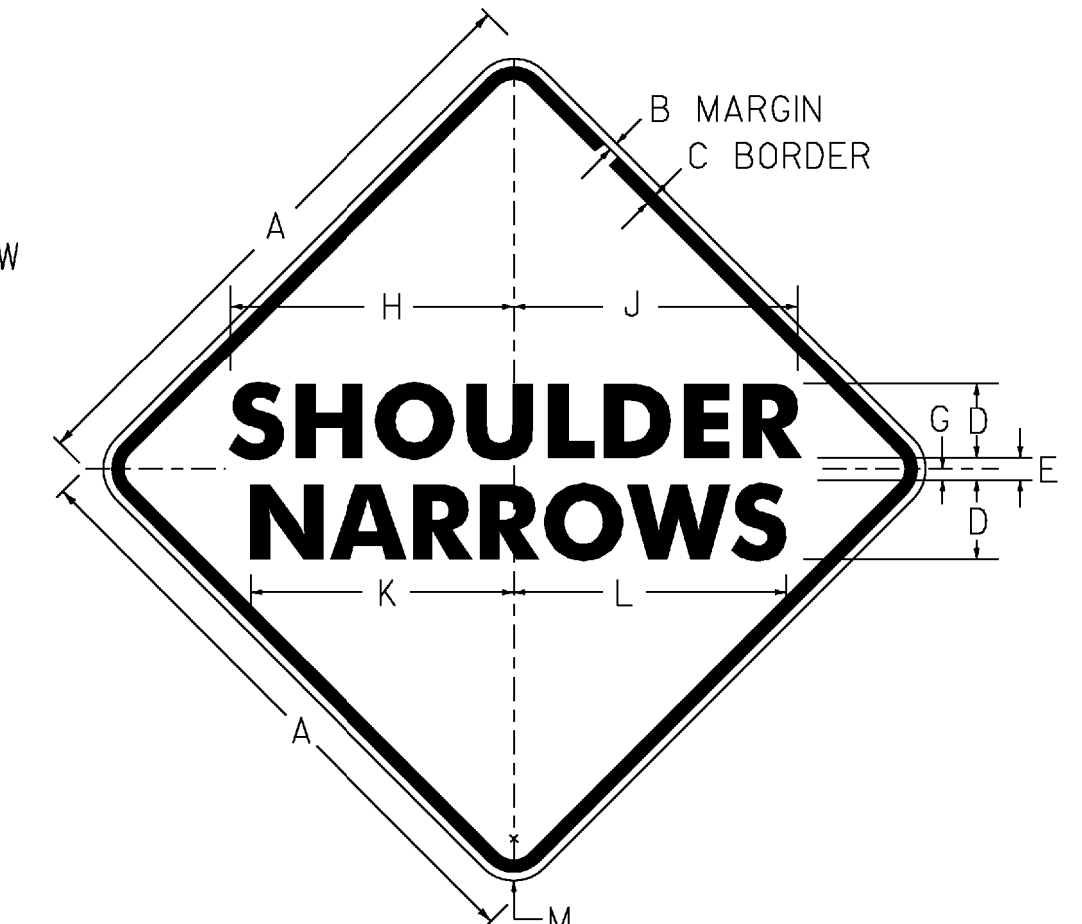

VW-619

COLORS: LEGEND - BLACK
 BACKGROUND - YELLOW

SIGN	DIMENSIONS (INCHES)											
	A	B	C	D	E	F	G	H	J	K	L	M
MIN & STD.	36	5/8	7/8	5C	3	6D	I	13 1/16	13 3/16	17 5/8	18 1/4	2 1/4
EXPWY.	48	3/4	1 1/4	7D	3 1/2	7D	I	23 13/16	23 7/8	21 1/2	21 1/16	3

PROJECT NAME: MORETOWN - NEWPORT TOWN

PROJECT NUMBER: STPG SIGN (28)

FILE NAME: 09B060_TS.DGN
 PROJECT LEADER: N. AVERY
 DESIGNED BY: N. AVERY
 SIGN DETAILS 2

PLOT DATE: 30-SEP-2009
 DRAWN BY: N. AVERY
 CHECKED BY: A. GAMBLE
 SHEET 6 OF 166