

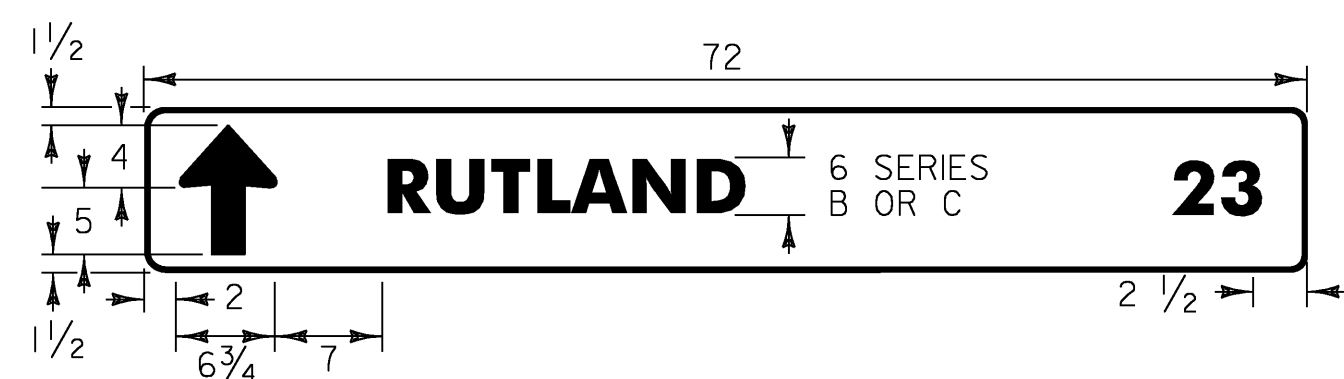

D1-1

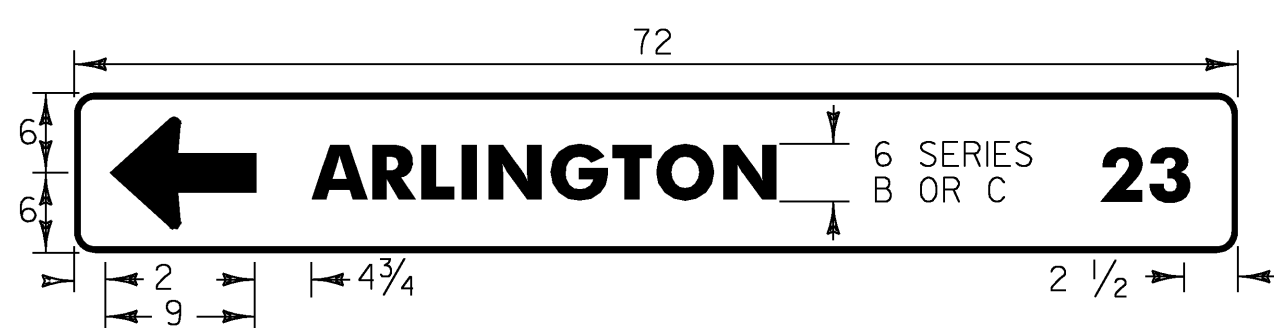

D1-1A



D1-1A

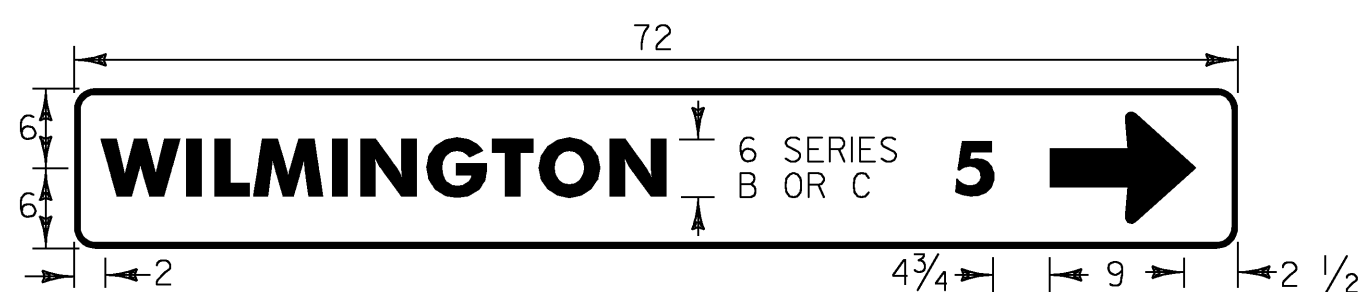

D1-1A

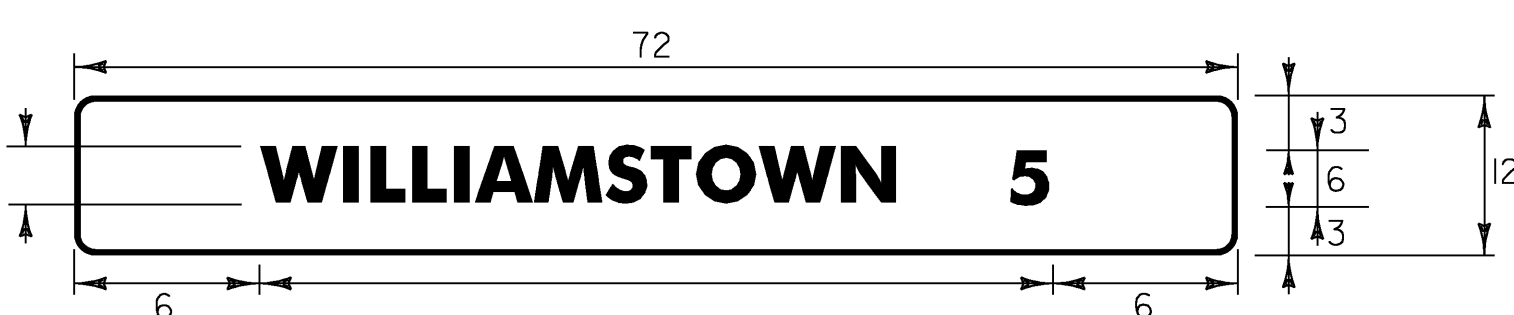

D2-1

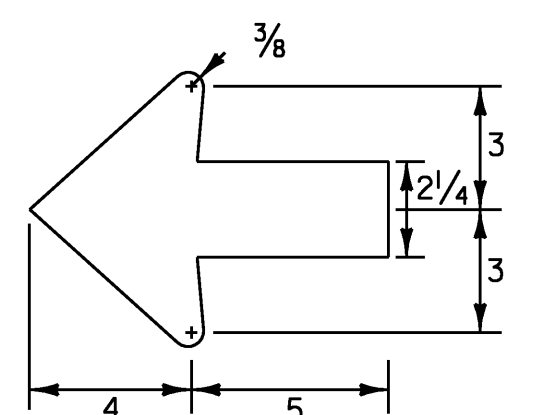

STANDARD ARROW

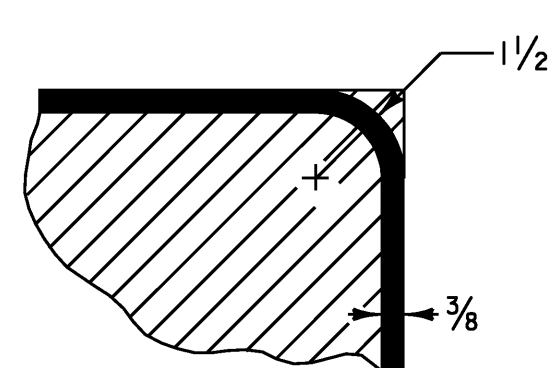

BORDER DETAIL

**STANDARD DESTINATION SIGN NOTES
D1-1, D1-1A, D1-2, D2-1**

1. THE SIGN BASE MATERIAL FOR STANDARD DESTINATION SIGNS SHALL BE HIGH DENSITY OVERLAYED PLYWOOD 3/8" THICK OR FLAT SHEET ALUMINUM 1/8" THICK.
2. THE DESTINATION SIGNS SHOWN ON THIS SHEET SHALL HAVE WHITE RETROREFLECTIVE ASTM TYPE III TEXT, ARROWS AND BORDERS ON A GREEN RETROREFLECTIVE ASTM TYPE III BACKGROUND. THE COLORS SHALL CONFORM WITH THE COLORS ADOPTED BY AASHTO AND APPROVED BY THE FHWA.
3. MULTIPLE ASSEMBLIES SHALL USE THE SAME SIZE THROUGHOUT. DO NOT MIX AND MATCH OLDER SIGN SIZES WITH NEW SIGN HEIGHTS AND WIDTHS.
4. ALL DIMENSIONS SHOWN IN INCHES UNLESS OTHERWISE NOTED.

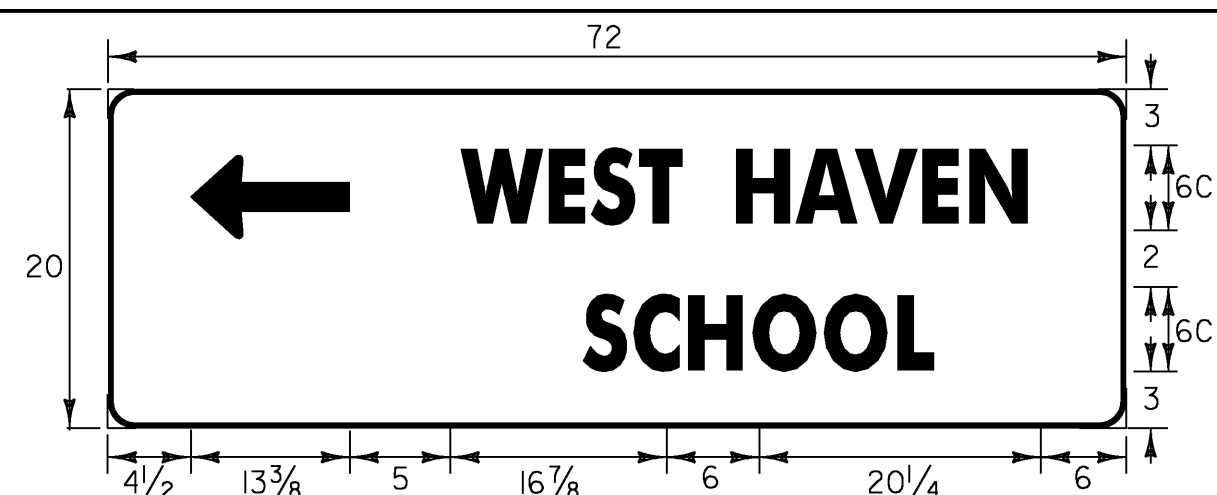

D1-2 (L)

LATERAL SPACING OF "SCHOOL" TEXT SHALL BE CENTERED TO TOP LINE TEXT.

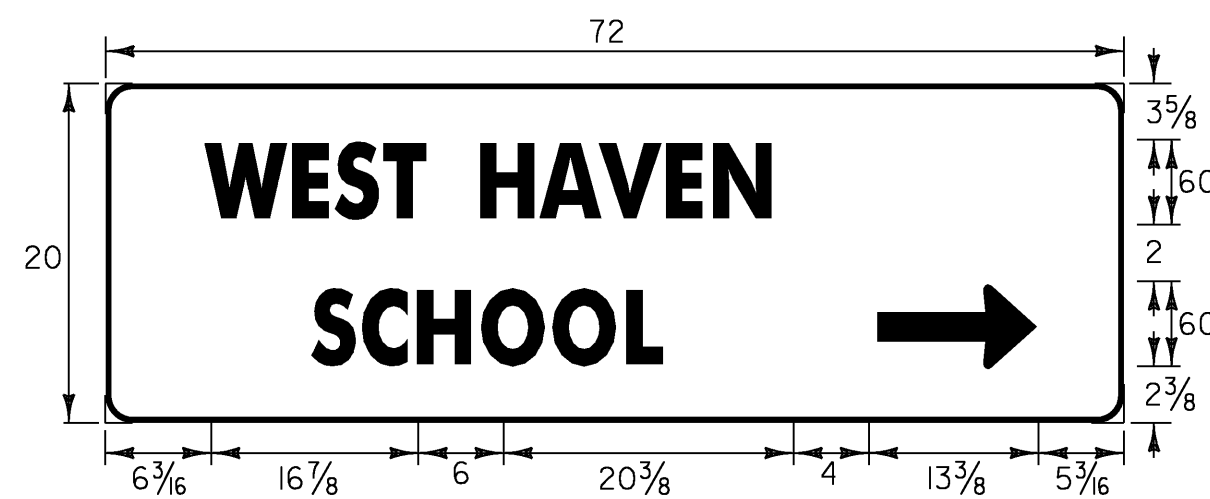

D1-2 (R)

LATERAL SPACING OF "SCHOOL" TEXT SHALL BE CENTERED TO TOP LINE TEXT.

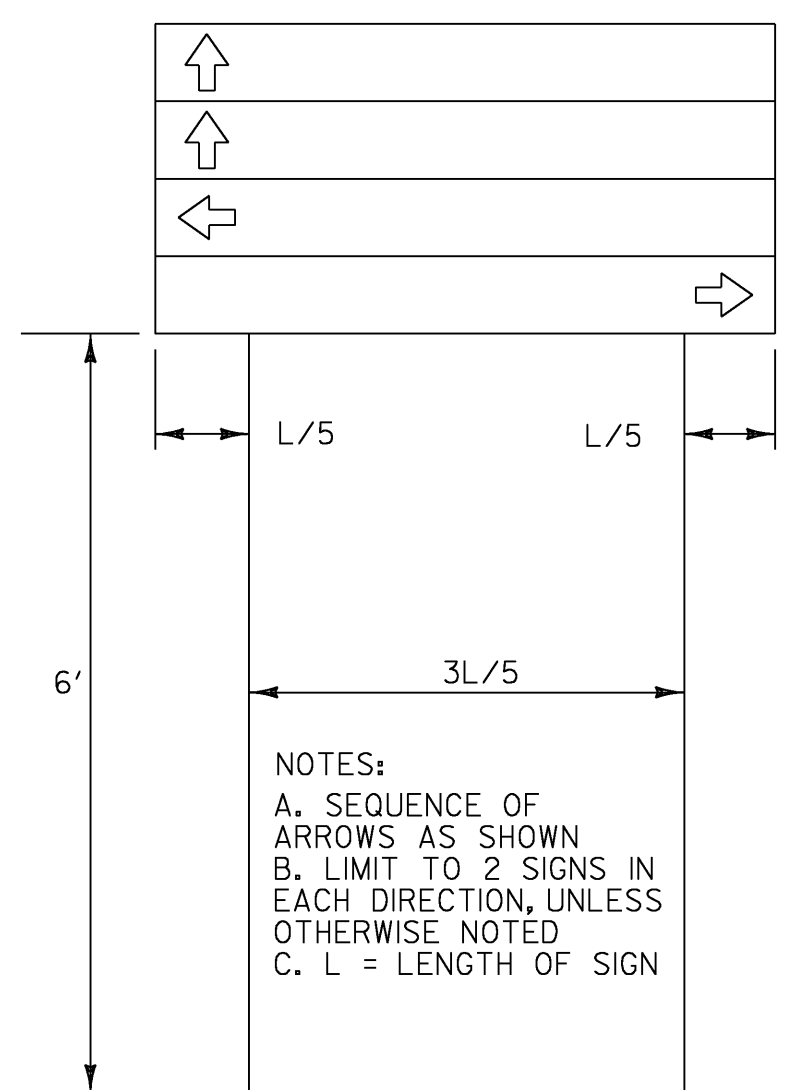

DESTINATION ASSEMBLY

- NOTES:
A. SEQUENCE OF ARROWS AS SHOWN
B. LIMIT TO 2 SIGNS IN EACH DIRECTION, UNLESS OTHERWISE NOTED
C. L = LENGTH OF SIGN



VR-105

1.5" RADIUS, 0.625" BORDER, 0.375" INDENT
COLORS: LEGEND - BLACK
BACKGROUND - WHITE
TEXT STYLE: "NO" C; "OVERNIGHT" C;
"CAMPING" C



1.5" Radius, 0.4" Border, White on Green;
Standard Arrow Custom 9.0" X 6.8" 180°; "STRATTON MTN" B specified length;
"SKI" C; "AREA" C; "10" B specified length;



1.5" Radius, 0.4" Border, White on Green;
Standard Arrow Custom 9.0" X 6.8" 180°; "HAYSTACK" B; "SKI" C; "AREA" C; "3" C;

D1-1A



1.5" Radius, 0.4" Border, White on Green;
Standard Arrow Custom 9.0" X 6.8" 90°; "MOUNT SNOW" B 90% spacing; "SKI" C;
"AREA" C; "7" C;

D1-1A

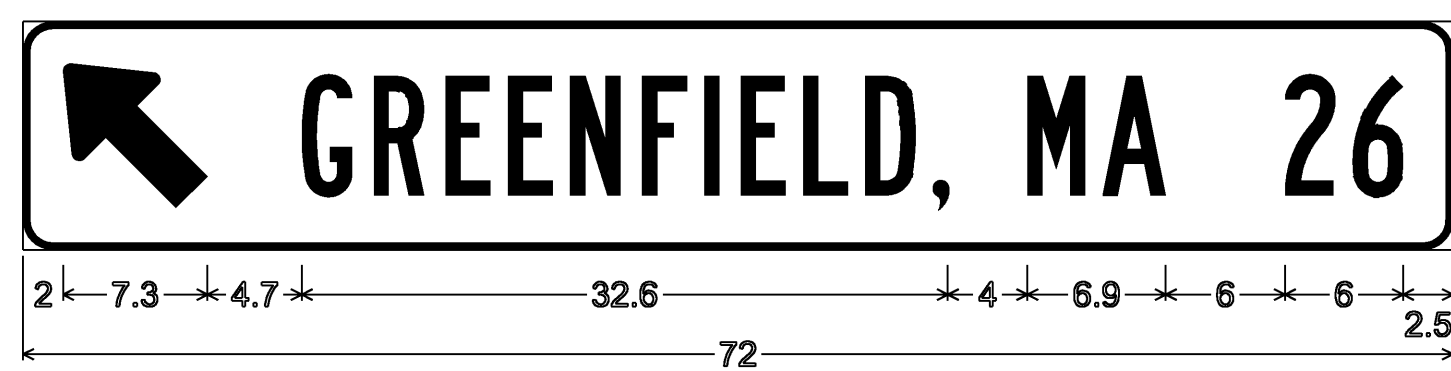

1.5" Radius, 0.4" Border, White on Green;
Arrow Custom - 9.0" 135°;
"GREENFIELD," B " " C "MA" B " " C "26" B specified length;

D1-1A

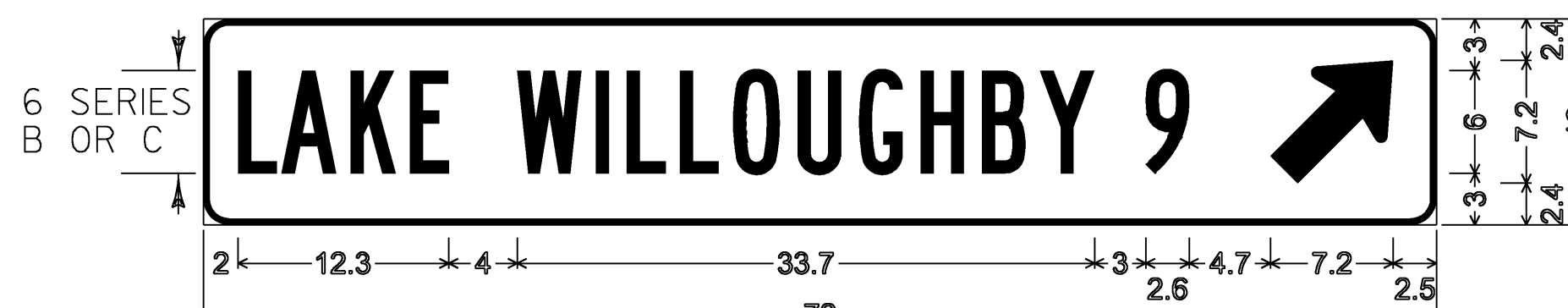

1.5" Radius, 0.4" Border, White on Green;
"LAKE WILLOUGHBY" B specified length; "9" B;
Standard Arrow Custom 9.0" X 6.0" 45°;

D1-1A



1.5" RADIUS, 0.625" BORDER, 0.375" INDENT
COLORS: LEGEND - RED
BACKGROUND - WHITE
TEXT STYLE: "BEGIN" C

VR-644p

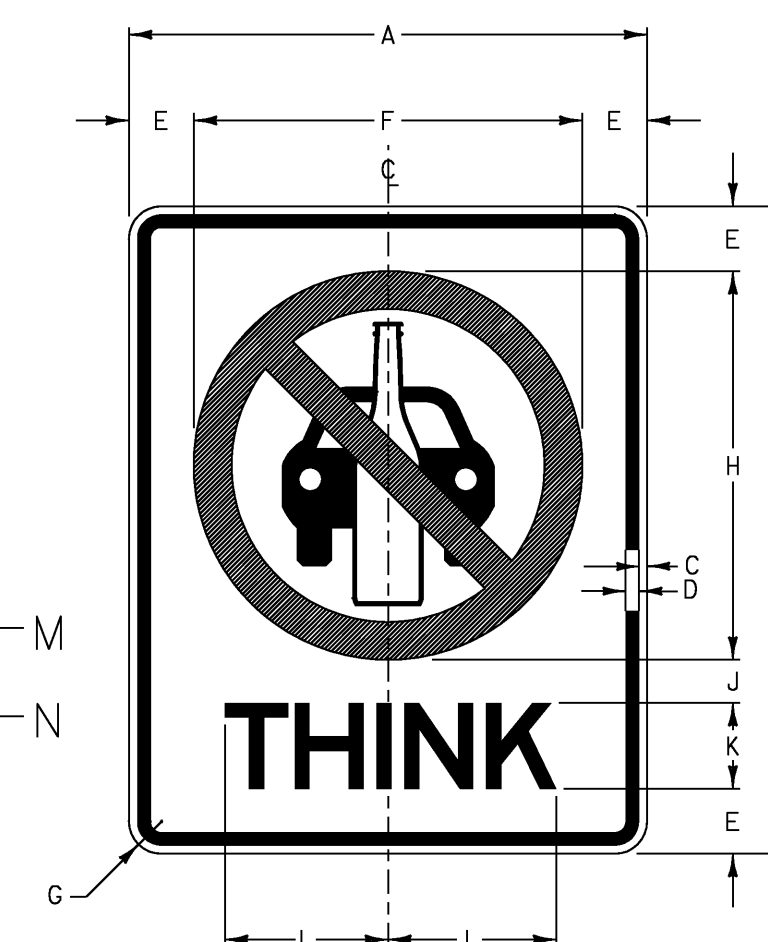
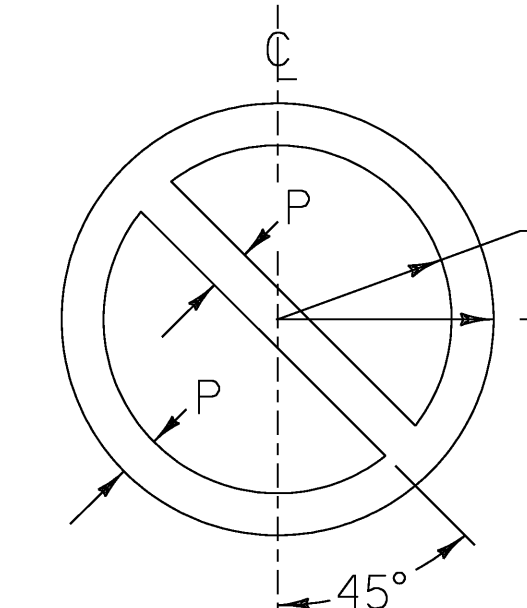
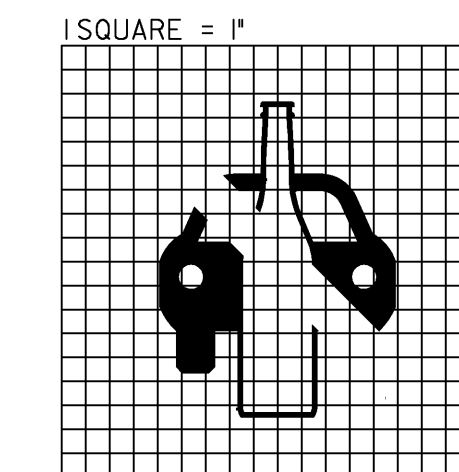

VR-072

COLORS
TEXT - BLACK (NON-REFL.)
CAR & BOTTLE SYMBOL - BLACK (NON-REFL.)
PROHIBITED SYMBOL - RED (NON-REFL.)
BACKGROUND - WHITE (REFL.)

SIGN	DIMENSIONS (INCHES)													
	A	B	C	D	E	F	G	H	J	K	L	M	N	P
STD.	24	30	3/8	5/8	3	18	1 1/2	18	2	4E	7 1/16	7 1/4	9	1 3/4

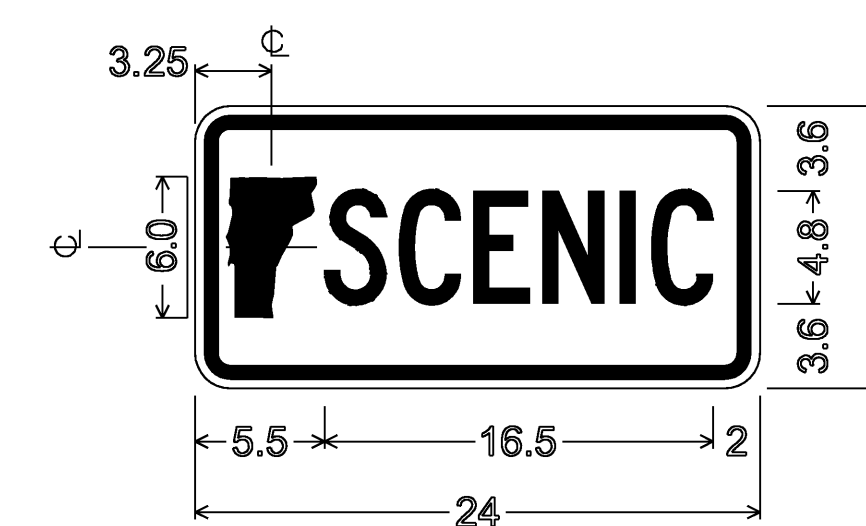

1.5" RADIUS, 0.625" BORDER, 0.375" INDENT
COLORS: LEGEND - GREEN
BACKGROUND - WHITE
TEXT STYLE: "SCENIC" C; SPECIFIED LENGTH

VM-064

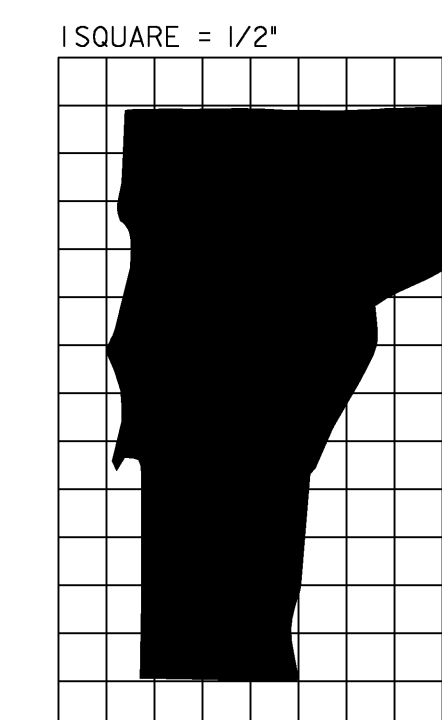

PROJECT NAME: LUDLOW - WAITSFIELD

PROJECT NUMBER: STPG SIGN (27)

FILE NAME: 09B058_TS.DGN
PROJECT LEADER: N. AVERY
DESIGNED BY: N. AVERY
SIGN DETAILS I

PLOT DATE: 16-SEP-2009
DRAWN BY: N. AVERY
CHECKED BY: A. GAMBLE
SHEET 5 OF 204