

STATE OF VERMONT AGENCY OF TRANSPORTATION



PROPOSED IMPROVEMENT TOWNS OF HARTFORD - EAST MONTPELIER COUNTIES OF WINDSOR, ORANGE, AND WASHINGTON VERMONT ROUTE 14

BEGINNING NORTH OF THE INTERSECTION OF US ROUTE 4, US ROUTE 5, AND VT ROUTE 14 IN THE TOWN OF HARTFORD
AT MILE MARKER 1.477 AND EXTENDING NORTHERLY ALONG VT ROUTE 14 FOR A DISTANCE OF 56.53 MILES
TO THE EAST MONTPELIER - CALAIS TOWN LINE AT MILE MARKER 5.821.
EXCLUDING CLASS 1 SECTIONS WITHIN THE PROJECT CORRIDOR.

LENGTH OF ROADWAY = 56.530 MILES
LENGTH OF PROJECT = 53.576 MILES

WORK TO BE PERFORMED UNDER THIS PROJECT INCLUDES THE REMOVAL OF EXISTING SIGNS AND POSTS
AND THE INSTALLATION OF NEW SIGNS AND SIGN POSTS AND INCIDENTAL ITEMS.

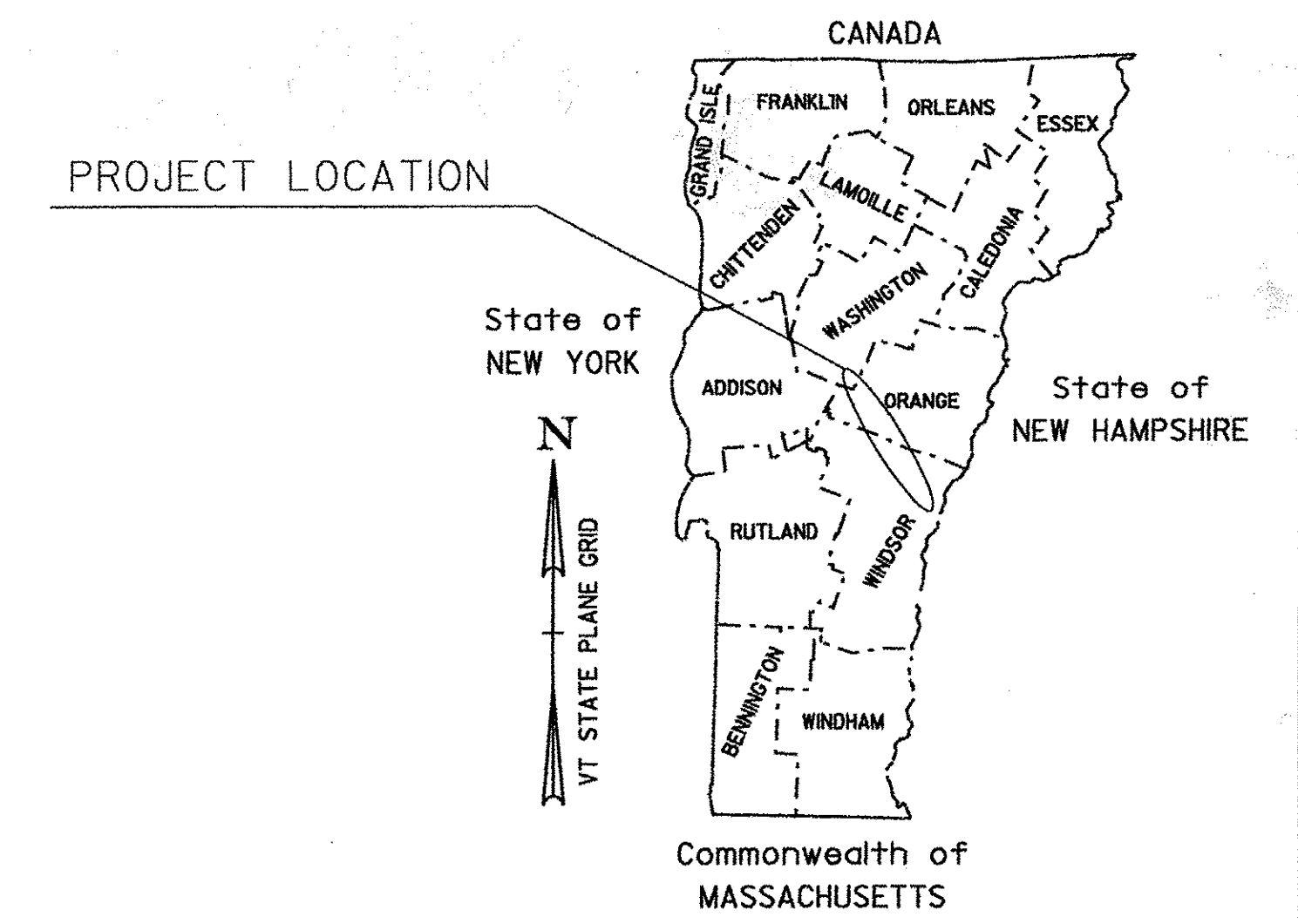

INDEX OF SHEETS
SEE SHEET 2

RECORD PLANS	
CONTRACTOR:	F. R. LAFAYETTE, INC. - ESSEX JUNCTION, VT
RESIDENT ENGINEER:	PAUL PERRY
CONSTRUCTION BEGAN:	SEPTEMBER 28, 2009
CONSTRUCTION COMPLETE:	JUNE 16, 2011
RECORD PLANS BY:	PAUL PERRY & AMOS KEMPTON
I HEREBY CERTIFY THAT ALL THE CONSTRUCTION REQUIRED BY THIS SET OF DRAWINGS HAS BEEN ACCOMPLISHED AS INDICATED HEREIN.	
BY	<i>Paul K. Perry</i> RESIDENT ENGINEER
DATE	9/12/11
NOTE: Any further information concerning final quantities, amounts or other details relative to this project may be found at Central Files in the electronic archives.	

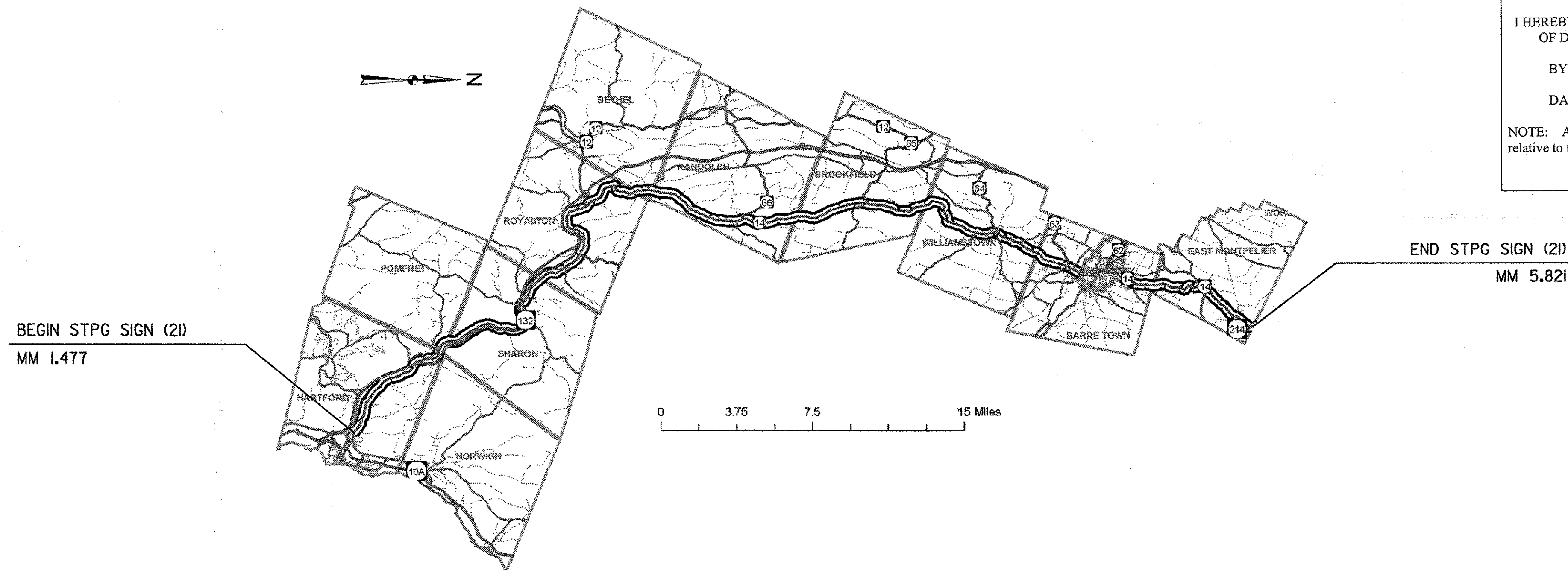

CONVENTIONAL SYMBOLS	
COUNTY LINE	
TOWN LINE	
LIMITS OF ACCESS	
POINT OF ACCESS	
FENCE LINE	
STONE WALL	
TRAVELED WAY	
GUARD RAIL	
RAILROAD	
SURVEY LINE	
CULVERT	
POWER POLE	
TELEPHONE POLE	
TREES	
CONTROL OF ACCESS	
PROPERTY LINE	
R.O.W. TAKING LINE	
SLOPE RIGHTS	
TOP OF CUT	
TOE OF SLOPE	

SURVEYED BY :	N/A
SURVEYED DATE :	N/A
DATUM	
VERTICAL	N/A
HORIZONTAL	N/A

THESE PLANS ARE SUBJECT TO SUCH ENGINEERING CHANGES AS MAY BE REQUIRED BY THE FEDERAL HIGHWAY ADMINISTRATION OR THE DIRECTOR OF PROGRAM DEVELOPMENT.
CONSTRUCTION IS TO BE CARRIED ON IN ACCORDANCE WITH THESE PLANS AND THE STANDARD SPECIFICATIONS FOR CONSTRUCTION DATED 2006, AS APPROVED BY THE FEDERAL HIGHWAY ADMINISTRATION ON JUNE 15, 2006 FOR USE ON THIS PROJECT, INCLUDING ALL SUBSEQUENT REVISIONS AND SUCH REVISED SPECIFICATIONS AND SPECIAL PROVISIONS AS ARE INCORPORATED IN THESE PLANS.

DIRECTOR OF PROGRAM DEVELOPMENT	
APPROVED <i>Paul K. Perry</i>	DATE 6-15-09
PROJECT MANAGER :	AMY GAMBLE
PROJECT NAME :	HARTFORD - EAST MONTPELIER
PROJECT NUMBER :	STPG SIGN (21)
SHEET 1 OF 162 SHEETS	

INDEX SHEETS

1	TITLE SHEET
2	GENERAL NOTES
3	QUANTITY SHEET
4	COUNTY/ TOWN LINE DESIGN
5-6	SIGN DETAILS
7	GUIDE SIGN ASSEMBLY
8-15	HARTFORD TRAFFIC SIGN SUMMARY SHEETS 1-8
16-29	SHARON TRAFFIC SIGN SUMMARY SHEETS 1-14
30-60	ROYALTON TRAFFIC SIGN SUMMARY SHEETS 1-31
61-63	BETHEL TRAFFIC SIGN SUMMARY SHEETS 1-3
64-87	RANDOLPH TRAFFIC SIGN SUMMARY SHEETS 1-24
88-96	BROOKFIELD TRAFFIC SIGN SUMMARY SHEETS 1-9
97-114	WILLIAMSTOWN TRAFFIC SIGN SUMMARY SHEETS 1-18
115-135	BARRE TOWN TRAFFIC SIGN SUMMARY SHEETS 1-22
136-159	EAST BARRE TRAFFIC SIGN SUMMARY SHEETS 1-24
160	TOWN TOTAL SIGN SUMMARY SHEET
161-162	TRAFFIC CONTROL SHEETS

STANDARDS

E-120	STANDARD SIGN PLACEMENT EXPRESSWAY AND FREEWAY	08/08/1995
E-121	STANDARD SIGN PLACEMENT CONVENTIONAL ROAD	08/08/1995
E-123	GUIDE SIGN PLACEMENT	03/16/2004
E-127	ROUTE MARKINGS AT RURAL INTERSECTIONS	08/08/1995
E-128A	VILLAGE SIGNS A-M	08/08/1995
E-128B	VILLAGE SIGNS N-W	08/08/1995
E-136B	STATE ROUTE MARKER SIGN DETAILS	08/08/1995
E-138	MILEMARKER DETAILS STATE AND TOWN HIGHWAYS	05/30/2003
E-141	REGULATORY SIGN DETAILS	09/20/1995
E-144	REGULATORY SIGN DETAILS	03/29/1999
E-145A	REGULATORY SIGN DETAILS LANE USE CONTROL SIGNS	12/23/1994
E-145B	REGULATORY SIGN DETAILS LANE USE CONTROL SIGNS	12/23/1994
E-153	WARNING SIGN DETAILS	05/01/2004
E-154	WARNING SIGN DETAILS	05/01/2004
E-164	SQUARE STEEL POSTS	05/20/1999

CLASS I SECTIONS OF HIGHWAY TO BE EXCLUDED FROM THIS PROJECT

TOWN	BEGIN MM	END MM	DISTANCE
HARTFORD	0.000	1.477	1.477

TOTAL CLASS I MILEAGE 1.477

- BARRE CITY IN ITS ENTIRETY IS CLASS I AND WILL NOT APPEAR IN THIS PROJECT.

GENERAL NOTES

- ALL NEW SIGNS SHALL BE IN ACCORDANCE WITH THESE PLANS, THE LATEST EDITION OF THE 2003 MANUAL ON UNIFORM TRAFFIC CONTROL DEVICES, THE STANDARD HIGHWAY SIGN BOOK (SHS) PUBLISHED BY THE FEDERAL HIGHWAY ADMINISTRATION (FHWA), AND APPLICABLE VTRANS E-SERIES STANDARDS OR AS DIRECTED BY THE ENGINEER. SIGN LOCATIONS AS SHOWN ON THE PLANS ARE APPROXIMATE. EXACT LOCATIONS TO BE DETERMINED BY THE ENGINEER IN THE FIELD.
- ALL SIGNS WITHIN THE PROJECT LIMITS ARE TO BE REPLACED UNLESS OTHERWISE NOTED OR AS DIRECTED BY THE RESIDENT ENGINEER.
- THE CONTRACTOR SHALL BE RESPONSIBLE FOR REPAIRING ANY DAMAGE TO PRIVATE OR PUBLIC PROPERTY CAUSED BY THE CONTRACTOR, AT THEIR EXPENSE.
- ALL EXISTING MILE MARKER PLAQUES ATTACHED TO A DELINEATOR POST OR ATTACHED TO A RETAINED STAND ALONE SIGN POST ASSEMBLY SHALL BE RETAINED. IF AN EXISTING MILE MARKER PLAQUE IS ATTACHED TO A SIGN POST THAT IS TO BE REMOVED AND REPLACED IN THE SAME LOCATION, THE MILE MARKER PLAQUE SHALL BE REMOVED, SALVAGED AND INSTALLED TO THE NEW SIGN POST. IF AN EXISTING MILE MARKER PLAQUE IS ATTACHED TO A SIGN POST THAT IS TO BE RELOCATED TO A DIFFERENT LOCATION, THE MILE MARKER PLAQUE SHALL BE REMOVED, UNLESS OTHERWISE DIRECTED BY THE ENGINEER. PAYMENT FOR ANY OF THIS WORK SHALL BE INCIDENTAL TO ITEM 675.34(SQUARE TUBE POST AND ANCHOR. PAYMENT FOR NEW MILE MARKERS AS SHOWN ON THESE PLANS SHALL BE PAID FOR AS ITEM 675.20 TRAFFIC SIGN, TYPE A.
- SALVAGED SIGN TOTALS HAS BEEN ADDED TO THE TOTAL SIGN REMOVAL COLUMN ON THE TOWN TOTAL SIGN SUMMARY SHEET.
- EXISTING STREET NAME SIGNS ATTACHED TO SIGN POSTS THAT ARE TO BE REMOVED, SHALL BE REMOVED AND INSTALLED ONTO NEW POST. ALL WORK AND MATERIALS NECESSARY TO REMOVE AND INSTALL THE STREET NAME PLAQUES SHALL BE PAID FOR UNDER ITEM 675.60 ERECTING SALVAGED SIGNS. AN ESTIMATED QUANTITY HAS BEEN ADDED TO ITEM 675.60 TO PAY FOR THIS WORK.
- ALL EXISTING STREET NAME PLAQUES INSTALLED ON STAND ALONE SIGN POSTS SHALL BE RETAINED WITHIN THE PROJECT LIMITS.
- ALL SIGN PLACEMENT SHALL BE IN CONFORMANCE WITH STATE STANDARD E-120 STANDARD SIGN PLACEMENT CONVENTIONAL ROADS AND E-121 STANDARD SIGN PLACEMENT EXPRESSWAY AND FREEWAY.
- ALL SIGN LETTERING, DIGITS, ARROWS, AND DESIGN OF SYMBOLS FOR SIGNS DETAILED REFERENCED IN THESE PLANS SHALL CONFORM WITH THE "STANDARD ALPHABET FOR HIGHWAY SIGNS AND PAVEMENT MARKING" AS ADOPTED BY THE U.S. DEPARTMENT OF TRANSPORTATION AND THE FEDERAL HIGHWAY ADMINISTRATION (FHWA), UNLESS DETAILED WITHIN THESE PLANS.
- ALL COLORS SHALL CONFORM WITH THE STANDARD COLORS ADOPTED BY THE AMERICAN ASSOCIATION OF STATE HIGHWAY AND TRANSPORTATION OFFICIALS (AASHTO) AND APPROVED BY FHWA, UNLESS OTHERWISE NOTED.
- WITHIN THE TRAFFIC SIGN SUMMARY SHEETS FY = FLUORESCENT YELLOW SHEETING (ASTM VII, VIII, OR IX) AND FYG = FLUORESCENT YELLOW-GREEN SHEETING (ASTM TYPE VII, VIII, OR IX).
- SALVAGED SIGNS CALCULATED IN THE TRAFFIC SIGN SUMMARY SHEET HAVE BEEN INCLUDED INTO THE TOTAL FOR REMOVING SIGNS.
- UNLESS OTHERWISE DETAILED ON THE PLANS, ALL SIGN BASE MATERIAL SHALL BE FLAT SHEET ALUMINUM WITH THE FOLLOWING MINIMUM THICKNESSES:

SIZES	24" X 10"	36" X 12"	48" X 18"	48" X 24"
	24" X 12"	36" X 15"	48" X 18"	48" X 24"
	24" X 18"	36" X 15"	48" X 18"	48" X 24"
	24" X 24"	36" X 18"	48" X 18"	48" X 24"
	24" X 30"	36" X 24"	48" X 18"	48" X 24"
	30" X 15"	30" X 42"	48" X 30"	48" X 30"
	30" X 18"	36" X 36"	48" X 42"	48" X 42"
	30" X 30"	36" X 48"	48" X 48"	48" X 48"
	30" X 42"	36" X 54"	48" X 60"	48" X 60"
THICKNESS	0.060"	0.080"	0.100"	0.125"

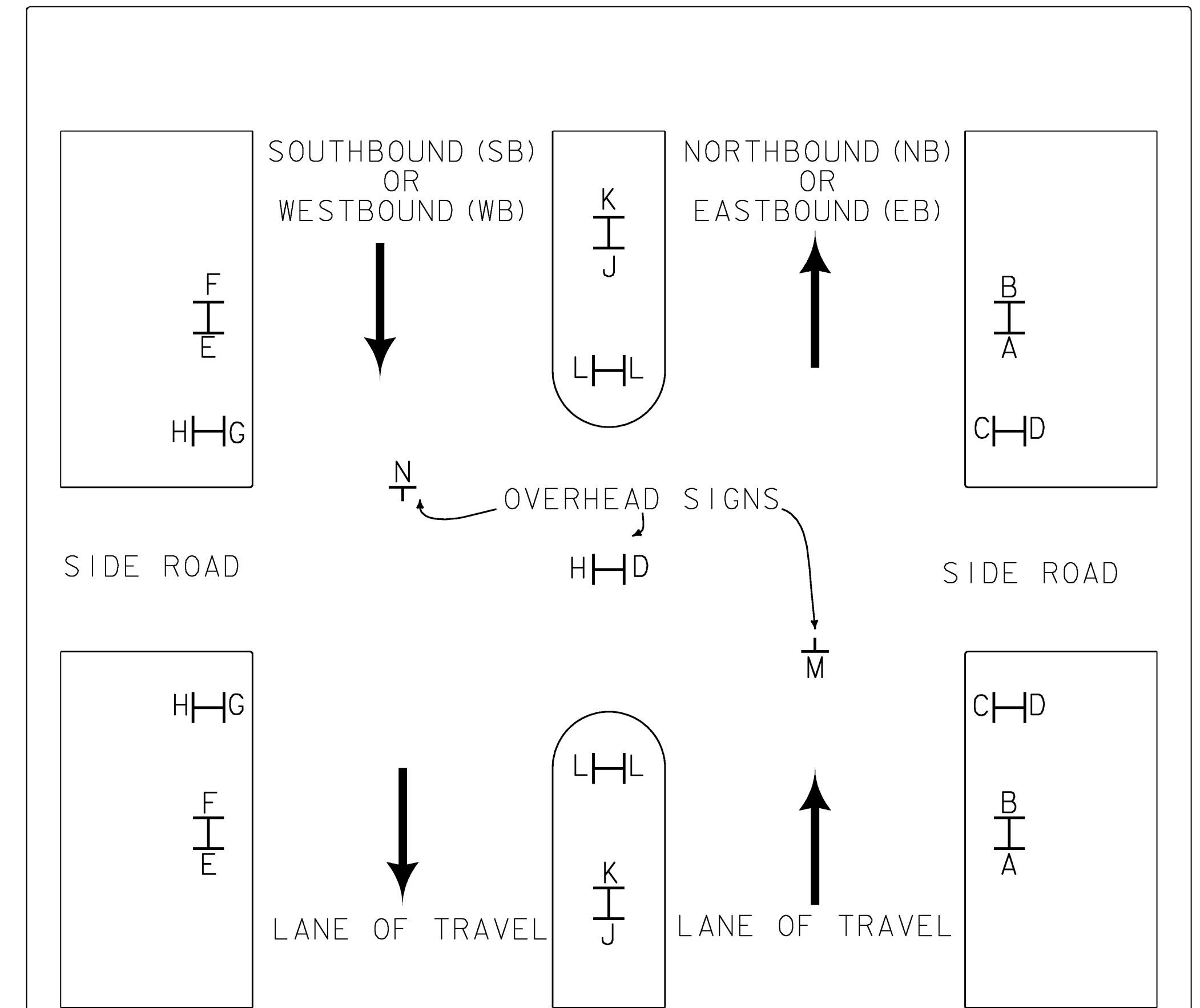

THE TRAFFIC SIGN LOCATION CODES ARE TO BE USED IN CONJUNCTION WITH THE SIGN SUMMARY SHEETS TO ESTABLISH PROPER SIGN INSTALLATION IN THE FIELD.

TRAFFIC SIGN LOCATION CODES
NOT TO SCALE

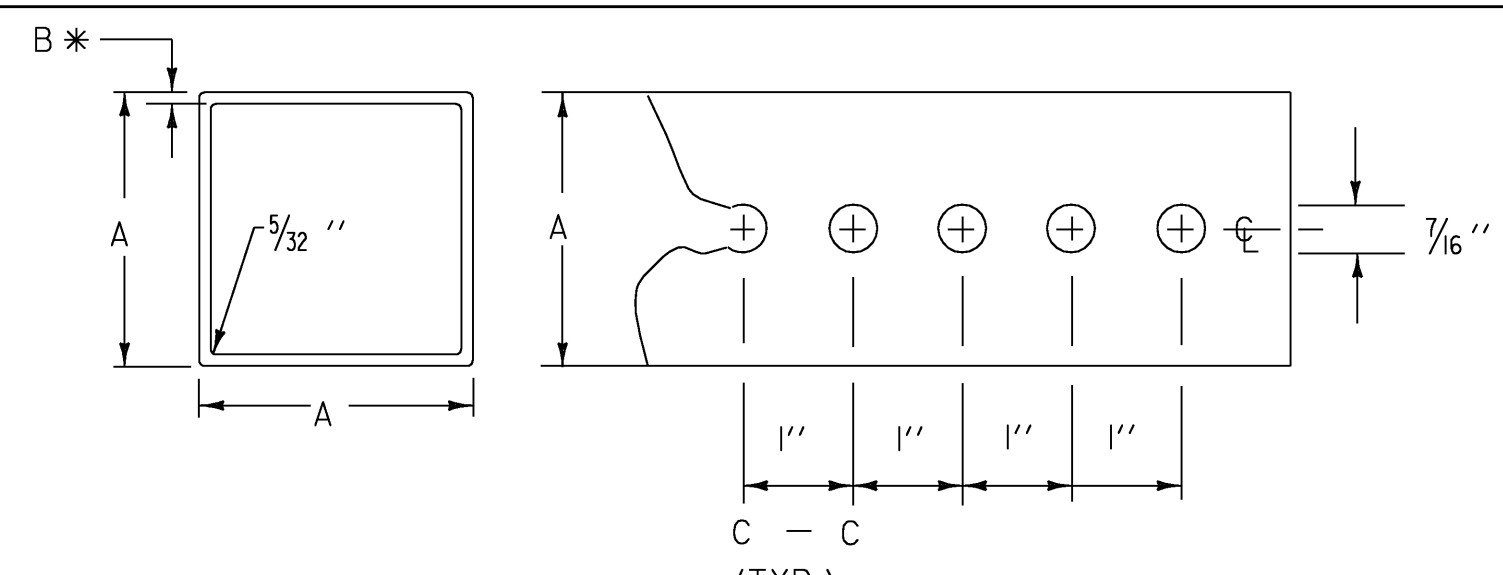

SIGN POST NOTES :

THE POSTS SHALL BE CAREFULLY FORMED OF STEEL WITH A MINIMUM YIELD OF 55,000 PSI, INTO A SIZE AND SHAPE WITH CORNERS INDUCTION WELDED IN SUCH A MANNER THAT NEITHER FLASH NOR WELD SHALL INTERFERE WITH THE TELESCOPING PROPERTIES, NOR DAMAGE THE GALVANIZING.

*THE WALL THICKNESS TOLERANCES SHALL BE +.005" AND -.010" FOR THE 12 GAUGE.

*THE WALL THICKNESS TOLERANCES SHALL BE +.002" AND -.008" FOR THE 14 GAUGE.

DIMENSION DETAILS AND POST SELECTION CHART

POST SELECTION CHART								
SIGN AREA (FT ²) X H (FT) ≤ SV (SELECTION VALUE)								
POST SIZE	DIMENSIONS			SECTION MODULUS IN ³	ONE POST S _v	TWO POST S _v	THREE POST S _v	NUMBER PERMITTED IN 8' PATH
LBS./FT.	A	*B	GAUGE					
1.88	1 3/4"	.083	14	0.230	47	94	141	TWO
2.42	2"	.105	12	0.381	77	154	231	TWO
3.35	2 1/2"	.105	12	0.642	130	260	390	ONE

DESIGN CRITERIA:

WIND SPEED = 70 MPH (10 -YEAR MEAN RECURRENCE INTERVAL)
WIND PRESSURE = 19 PSF
STEEL MINIMUM YIELD = 55,000 PSI
ALLOWABLE STRESS = (1.4) 0.60 F_y

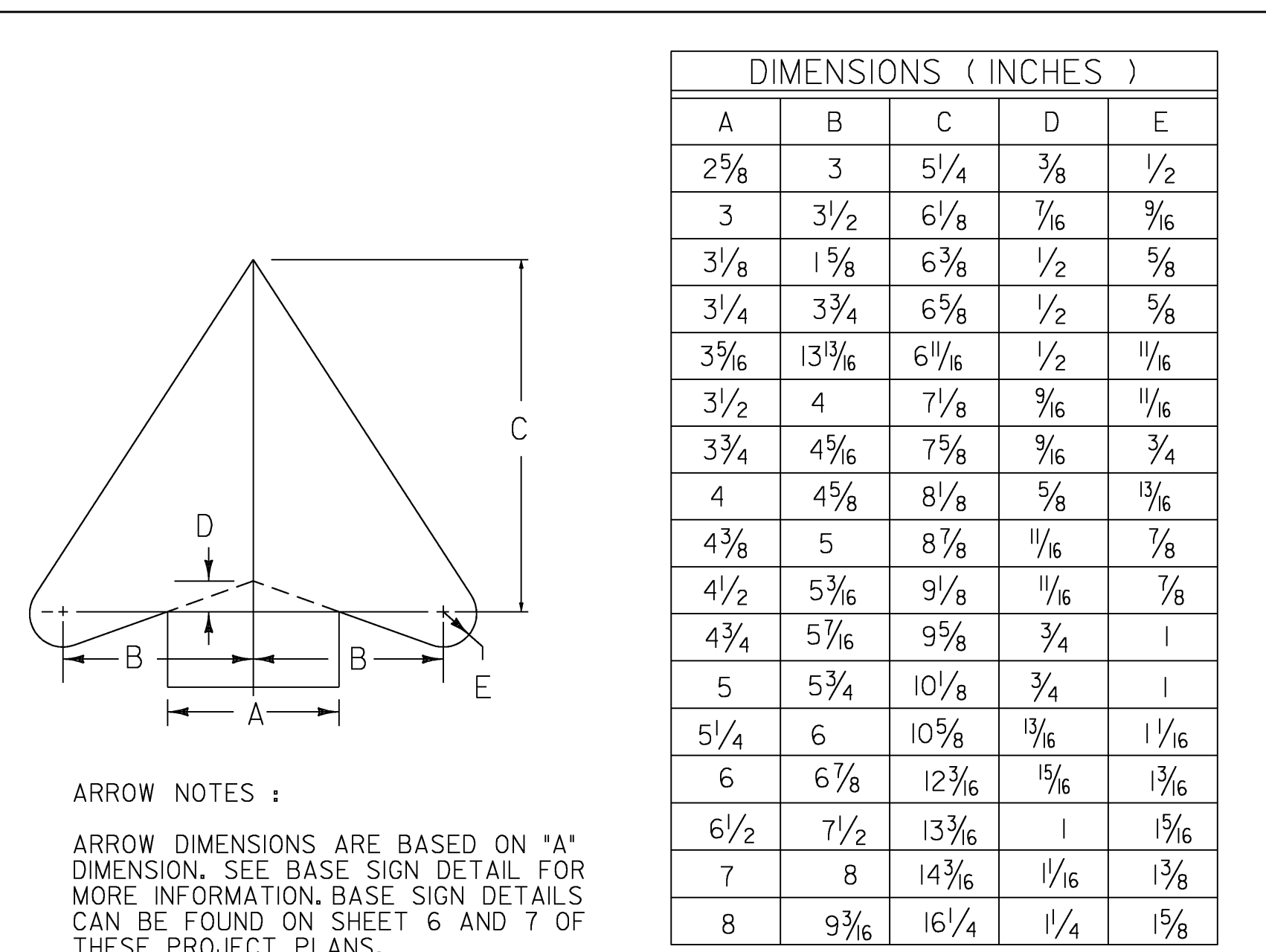

ARROW NOTES :

ARROW DIMENSIONS ARE BASED ON 'A' DIMENSION. SEE BASE SIGN DETAIL FOR MORE INFORMATION. BASE SIGN DETAILS CAN BE FOUND ON SHEET 6 AND 7 OF THESE PROJECT PLANS.

PROJECT NAME:	HARTFORD - EAST MONTPELIER
PROJECT NUMBER:	STPG SIGN (21)
FILE NAME:	09c024_TS.DGN
PROJECT LEADER:	N. AVERY
DESIGNED BY:	N. AVERY
GENERAL NOTES	
PLOT DATE:	11-JUN-2009
DRAWN BY:	N. AVERY
CHECKED BY:	A. GAMBLE
SHEET	2 OF 162

QUANTITY SHEET 1

SUMMARY OF ESTIMATED QUANTITIES											TOTALS			DESCRIPTIONS				DETAILED SUMMARY OF QUANTITIES		
											ROADWAY	GRAND TOTAL	FINAL	UNIT	ITEMS	ITEM NUMBER	ROUND	QUANTITIES	UNIT	ITEMS
											1	1		CY	TRENCH EXCAVATION OF EARTH, EXPLORATORY (N.A.B.I.)	204.22				
											48	48		HR	UNIFORMED TRAFFIC OFFICERS	630.10				
											792	792		HR	FLAGGERS	630.15				
											1	1		LS	MOBILIZATION/DEMOBILIZATION	635.11				
											1	1		LS	TRAFFIC CONTROL	641.10				
											4642.4	4642.4		SF	TRAFFIC SIGNS, TYPE A	675.20				
											11520	11520		LF	SQUARE TUBE SIGN POST AND ANCHOR	675.341				
											932	932		EACH	REMOVING SIGNS	675.50				
											61	61		EACH	ERECTING SALVAGED SIGNS	675.60				

PROJECT NAME: HARTFORD- EAST MONTPELIER
PROJECT NUMBER: STPG SIGN (2I)
FILE NAME: 09c024_TS.DGN PLOT DATE: 23-JUN-2009
PROJECT LEADER: N. AVERY DRAWN BY: N. AVERY
DESIGNED BY: N. AVERY CHECKED BY: A. GAMBLE
QUANTITY SHEET SHEET 3 OF 162

TEXT	SERIES	DIMENSIONS
ADDISON	C	28.27
ALBANY	C	25.88
ALBURGH	C	29.99
ANDOVER	C	30.05
ARLINGTON	B	29.35
ATHENS	C	24.49
AVERILL	C	26.44
BAKERSFIELD	B	32.50
BARNARD	C	30.49
BARNET	C	24.83
BARRE CITY	B	32.50
BARRE TOWN	B	32.50
BARTON	C	25.38
BELVIDERE	C	32.50
BENNINGTON	B	32.50
BENSON	C	25.41
BERKSHIRE	B	29.04
BERLIN	C	22.50
BETHEL	C	23.80
BLOOMFIELD	B	32.13
BOLTON	C	24.39
BRADFORD	C	32.50
BRAINTREE	C	32.50
BRANDON	C	30.46
BRATTLEBORO	B	32.50
BRIDGEWATER	B	32.50
BRIDPORT	C	32.06
BRIGHTON	C	32.06
BRISTOL	C	27.24
BROOKFIELD	B	31.91
BROWNINGTON	B	31.22
BRUNSWICK	B	30.60
BURKE	C	20.93
BUELS GORE	B	32.50
BURLINGTON	B	32.50
CABOT	C	20.50
CALAIS	C	22.22
CAMBRIDGE	B	29.74
CANAAN	C	25.15
CASTLETON	B	29.32
CAVENDISH	C	32.50
CHARLESTON	B	32.50
CHARLOTTE	B	29.32
CHELSEA	C	28.84
CHESTER	C	28.46
CHITTENDEN	B	30.56
CLARENDON	B	30.32
COLCHESTER	B	32.50
CONCORD	C	30.42
CORINTH	C	27.27
CORNWALL	C	32.50
COVENTRY	C	32.50
CRAFTSBURY	B	32.50
DANBY	C	21.65
DANVILLE	C	31.16
DERBY	C	21.15
DORSET	C	24.55
DOVER	C	20.74
DUMMERSTON	B	32.50
DUXBURY	C	30.75
EDEN	C	15.85
ENOSBURG	C	32.50
EAST HAVEN	B	32.50
E. MONTPELIER	B (5'')	32.50
ELMORE	C	25.46
ESSEX	C	20.38
FAIRFAX	C	27.05
FAIRFIELD	C	32.50
FAIR HAVEN	B	32.50
FAIRLEE	C	26.12
FAYSTON	C	28.85
FERDINAND	B	29.17
FERRISBURGH	B	32.50
FLETCHER	C	31.85
FRANKLIN	C	31.31

TEXT	SERIES	DIMENSIONS
GEORGIA	C	27.74
GLOVER	C	25.00
GOSHEN	C	25.16
GLASTENBURY	B (5'')	31.32
GRAFTON	C	29.31
GRAND ISLE	B	32.50
GRANVILLE	C	32.50
GREENSBORO	B	32.50
GROTON	C	25.35
GUILDHALL	C	32.50
GUILFORD	C	31.78
HALIFAX	C	27.14
HANCOCK	C	29.96
HARDWICK	C	32.50
HARTFORD	C	32.50
HARTLAND	C	32.50
HIGHGATE	C	31.14
HINESBURG	C	29.23
HOLLAND	C	29.22
HUBBARDTON	B	31.42
HYDE PARK	B	32.50
IRA	C	10.15
IRASBURG	C	32.37
ISLE LA MOTTE	B (5'')	32.50
JAMAICA	C	28.26
JAY	C	11.85
JERICHO	C	27.24
JOHNSON	C	30.39
KILLINGTON	C	30.16
KIRBY	C	18.99
LANDGROVE	B	30.33
LEICESTER	C	32.50
LEMINGTON	B	28.79
LONDONDERRY	B (5'')	32.18
LOWELL	C	25.04
LUDLOW	C	26.10
LUNENBERG	B	30.01
LYNDON	C	24.96
MAIDSTONE	B	29.51
MANCHESTER	B	32.50
MARLBORO	C	32.50
MARSHFIELD	B	32.47
MENDON	C	26.02
MIDDLEBURY	B	32.50
MIDDLESEX	B	29.06
MIDDLETOWN SPR	B (5'')	32.50
MILTON	C	22.63
MONTGOMERY	B	32.50
MONTPELIER	B	31.94
MORETOWN	C	32.50
MORGAN	C	26.52
MORRISTOWN	B	32.50
MOUNT HOLLY	B (5'')	31.97
MOUNT TABOR	B	32.02
NEWARK	C	25.65
NEWBURY	C	30.87
NEWFANE	C	29.73
NEW HAVEN	B	32.50
NEWPORT CITY	B (5'')	32.50
NEWPORT TOWN	B (5'')	32.50
NORTH HERO	B	32.50
NORTHFIELD	B	31.57
NORTON	C	25.60
NORWICH	C	28.77
ORANGE	C	25.88
ORWELL	C	25.57
PANTON	C	25.38
PAWLET	C	24.59
PEACHAM	C	30.23
PERU	C	16.38
PITTSFIELD	C	32.50
PITTSFORD	C	32.50
PLAINFIELD	B	29.65
PLYMOUTH	C	32.50
POMFRET	C	29.42

TEXT	SERIES	DIMENSIONS
POULTNEY	C	32.50
POWNA	C	26.35
PROCTOR	C	29.31
PUTNEY	C	24.83
RANDOLPH	C	32.50
READING	C	27.47
READSBORO	B	31.09
RICHFORD	C	32.06
RICHMOND	C	32.50
RIPTON	C	22.97
ROCHESTER	B	29.54
ROCKINGHAM	B	32.50
ROXBURY	C	30.44
ROYALTON	C	32.50
RUPERT	C	24.94
RUTLAND CITY	B (5'')	32.50
RUTLAND TOWN	B (5'')	32.50
RYEGATE	C	28.47
ST. ALBANS CITY	B (5'')	32.50
ST. ALBANS TOWN	B (5'')	32.50
ST. GEORGE	B	32.50
ST. JOHNSBURY	B (5'')	32.50
SALISBURY	C	32.50
SEARSBURG	B	30.93
SHAFTSBURY	B	32.50
SHARON	C	25.91
SHEFFIELD	C	32.50
SHELDON	C	29.42
SHOREHAM	C	32.50
SHREWSBURY	B	32.50
S. BURLINGTON	B (5'')	32.50
SOUTH HERO	B	32.50
SPRINGFIELD	B	32.50
STAMFORD	C	32.50
STARKSBORO	B	32.50
STOCKBRIDGE	B	32.50
STOWE	C	21.30
STRAFFORD	B	30.42
STRATTON	C	32.06
SUDBURY	C	30.77
SUNDERLAND	B	32.50
SUTTON	C	24.21
SWANTON	C	30.22
THETFORD	C	32.50
TINMOUTH	C	32.14
TOPSHAM	C	30.53
TOWNSHEND	B	31.70
TROY	C	16.54
TUNBRIDGE	C	32.50
UNDERHILL	C	32.50
VERGENNES	B	30.03
VERNON	C	25.79
VERSHIRE	C	31.72
WAITSFIELD	B	30.44
WALDEN	C	25.46
WALLINGFORD	B	32.50
WALTHAM	C	29.91
WARDSBORO	B	32.29
WARREN	C	25.99
WARRENS GORE	B (5'')	32.50
WASHINGTON	B	32.50
WATERBURY	B	31.40
WATERFORD	B	30.65
WATERVILLE	B	31.35
WEATHERSFIELD	B (5'')	32.50
WELLS	C	20.83
WEST FAIRLEE	B (5'')	32.50
WESTFIELD	C	32.50
WEST HAVEN	B	32.50
WESTFORD	C	32.50
WESTMINSTER	B	32.50
WESTMORE	C	32.50
WESTON	C	25.85

TEXT	SERIES	DIMENSIONS
WEST RUTLAND	B (5'')	32.50
WEST WINDSOR	B (5'')	32.50
WEYBRIDGE	C	32.50
WHEELLOCK	C	32.50
WHITING	C	25.86
WHITINGHAM	B	32.50
WILLIAMSTOWN	B (5'')	32.50
WILLISTON	C	32.50
WILMINGTON	B	32.16
WINDHAM	C	29.66
WINDSOR	C	28.77
WINHALL	C	28.24
WINOOSKI	C	30.81
WOLCOTT	C	29.38
WOODBURY	C	32.50
WOODFORD	C	32.50
WOODSTOCK	B	31.79
WORCESTER	B	30.76

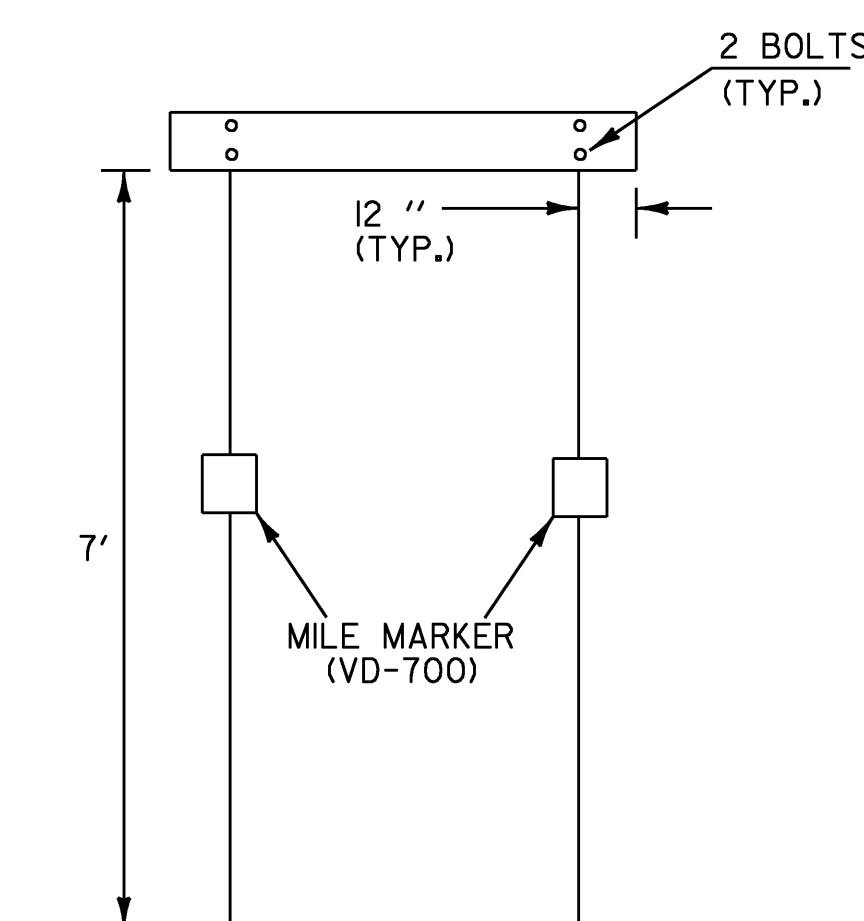

WHEN CROSSING COUNTY BOUNDARIES AN ADDITIONAL COUNTY LINE SIGN SHALL BE MOUNTED BELOW THE TOWN LINE SIGN MAINTAINING AN SEVEN FOOT CLEARANCE.

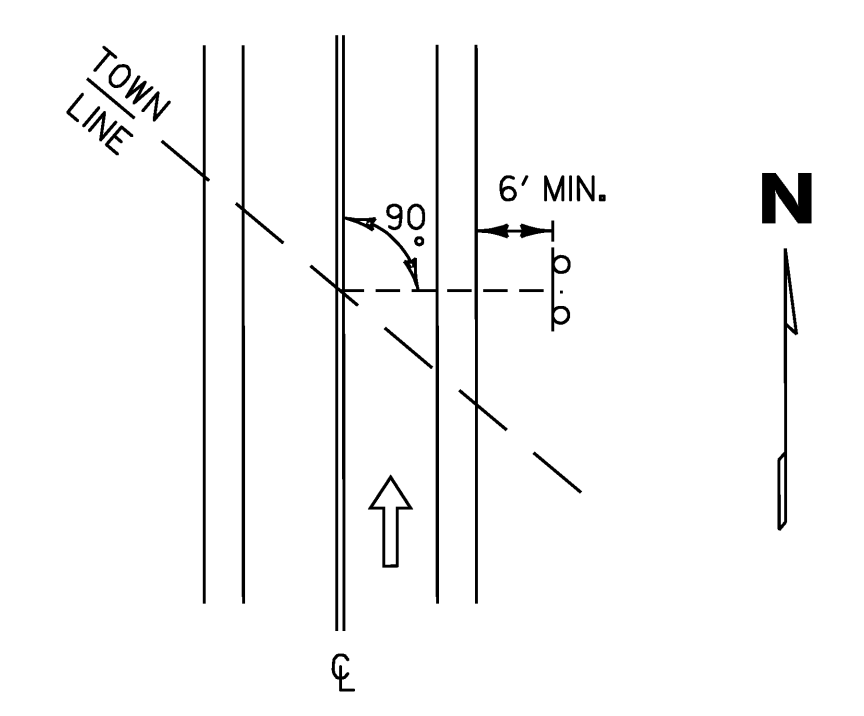

THE SIGN SHALL BE MOUNTED PARALLEL WITH THE ROADWAY, NORMALLY ON RIGHT SIDE TRAVELING WEST TO EAST OR SOUTH TO NORTH.

NOTES:

- WORD TO WORD SPACING FOR MULTIPLE TEXT TOWN NAMES IS ADJUSTABLE TO ACCOMMODATE DIMENSION REQUIREMENTS.
- DIMENSIONS SHOWN ARE APPROXIMATE AND MAY BE ADJUSTED SLIGHTLY TO ACCOMMODATE VARIOUS MANUFACTURER'S LETTER WIDTHS.
- ALL DIMENSIONS ARE IN INCHES UNLESS OTHERWISE NOTED

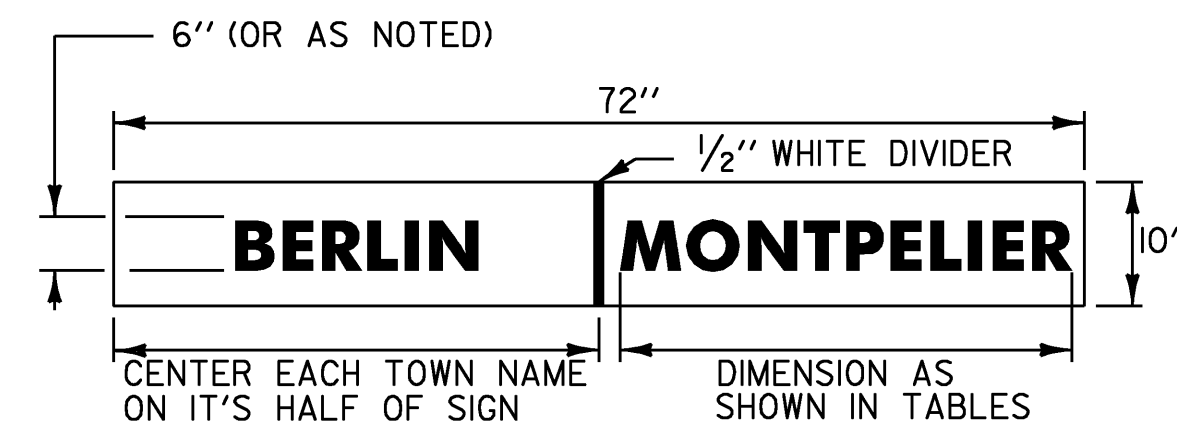

VD-024
VD-025 SIMILIAR

COUNTY NAMES

TEXT	SERIES	DIMENSIONS
ADDISON CO.	B	32.50
BENNINGTON CO.	B (5'')	32.50
CALEDONIA CO.	B (5'')	32.50
CHITTENDEN CO.	B (5'')	32.50
ESSEX CO.	C	32.50
FRANKLIN CO.	B (5'')	32.50
GRAND ISLE CO.	B (5'')	32.50
LAMOILLE CO.	B (5'')	32.50
ORANGE CO.	B	32.50
ORLEANS CO.	B	32.50
RUTLAND CO.	B	32.50
WASHINGTON CO.	B (5'')	32.50
WINDHAM CO.	B	32.50
WINDSOR CO.	B	32.50

VD-025

TOWN/COUNTY LINE SIGN NOTES:

- THE SIGN BASE MATERIAL SHALL BE HIGH DENSITY OVERLAIN PLYWOOD $\frac{5}{8}$ INCH THICK OR ALUMINUM SHEETING 0.125" MINIMUM THICKNESS. THE RETROREFLECTIVE MATERIAL SHALL BE SHEETING APPLIED TO THE ENTIRE BACKGROUND OF THE SIGN. THE LEGEND SHALL BE CUT-OUT RETROREFLECTIVE LEGEND. ALL RETROREFLECTIVE MATERIAL SHALL BE EQUAL TO OR EXCEEDING THE "THE AMERICAN SOCIETY OF TESTING AND MATERIALS" (ASTM) TYPE III.
- SIGNS SHALL HAVE A MINIMUM ASTM TYPE III SHEETING WITH A WHITE LEGEND ON A GREEN BACKGROUND.
- LEGEND SHALL CONFORM WITH THE STANDARD ALPHABETS FOR HIGHWAY SIGNS APPROVED BY THE NATIONAL JOINT COMMITTEE ON UNIFORM TRAFFIC CONTROL DEVICES.
- ALL SIGNS SHALL BE IN ACCORDANCE WITH "THE MANUAL ON UNIFORM TRAFFIC CONTROL DEVICES" (2003 MUTCD) AND THE "STANDARD HIGHWAY SIGNS" BOOK (SHS) PUBLISHED BY THE FEDERAL HIGHWAY ADMINISTRATION (FHWA).

PROJECT NAME:	HARTFORD-EAST MONTPELIER
PROJECT NUMBER:	STPG SIGN (2I)
FILE NAME:	09c024_TS.DGN
PROJECT LEADER:	N. AVERY
DESIGNED BY:	N. AVERY
COUNTY/ TOWNLINE DESIGN:	
PLOT DATE:	11-JUN-2009
DRAWN BY:	N. AVERY
CHECKED BY:	A. GAMBLE
SHEET	4 OF 162



D1-1

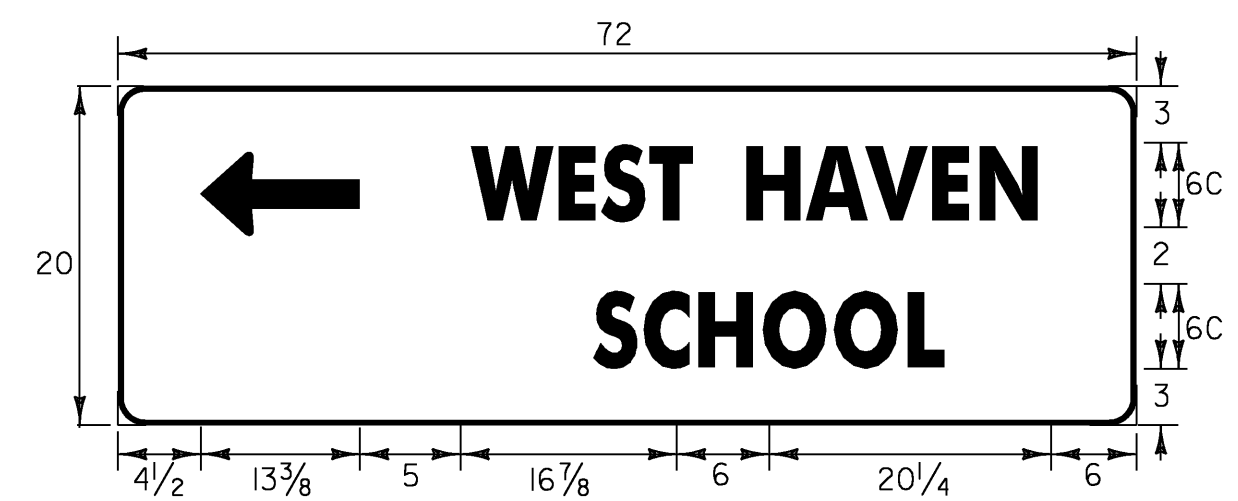

D1-2 (L)

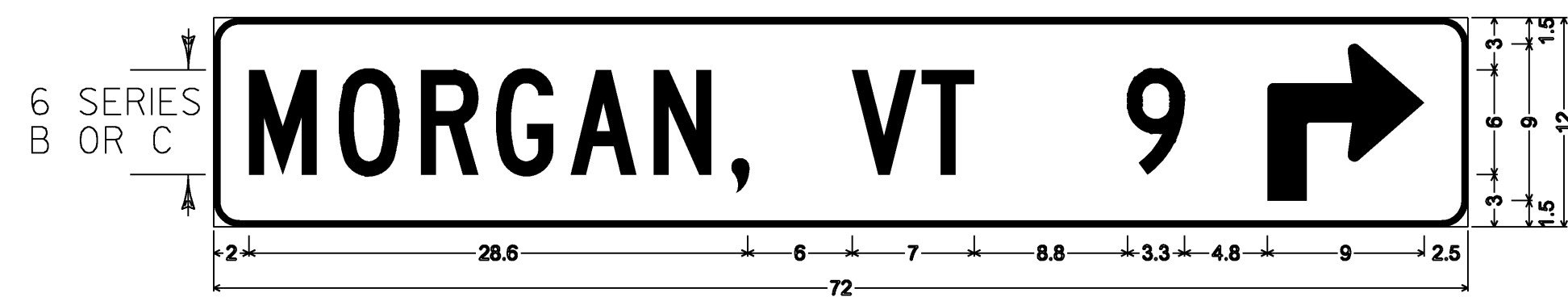

D1-1A

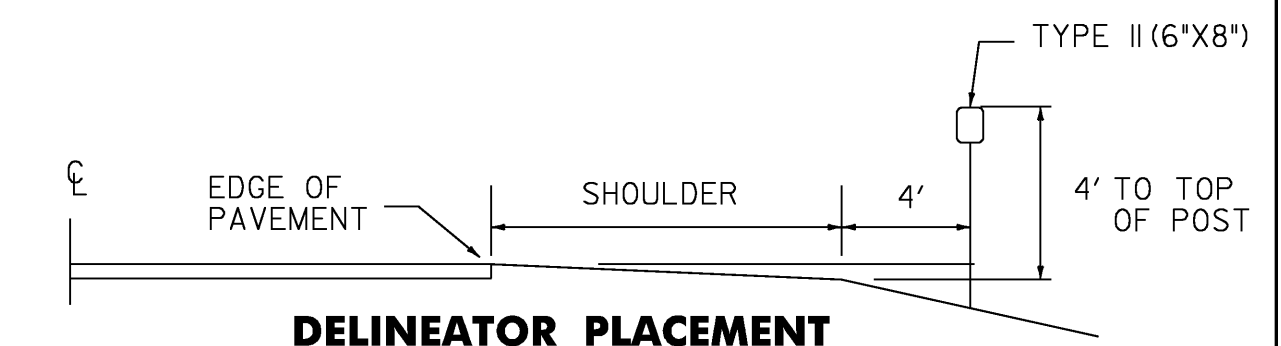

DELINEATOR PLACEMENT

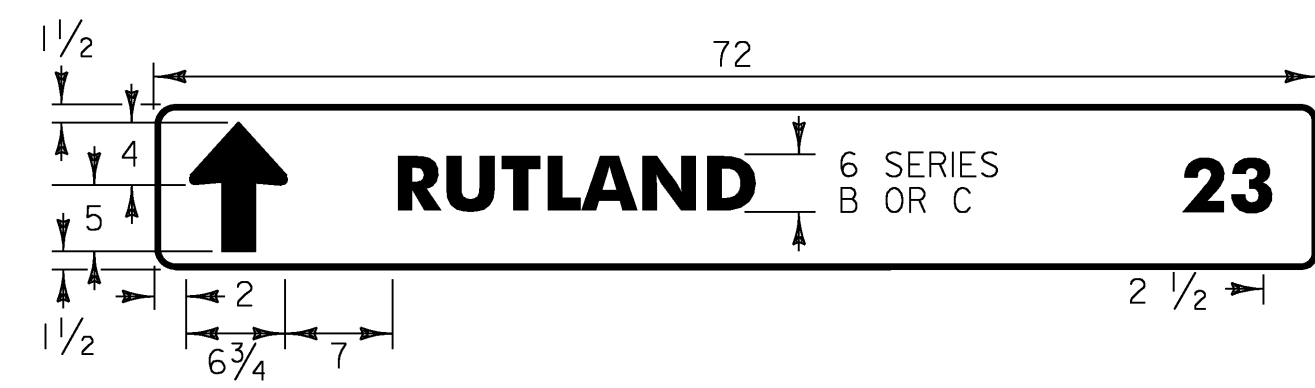

D1-1A

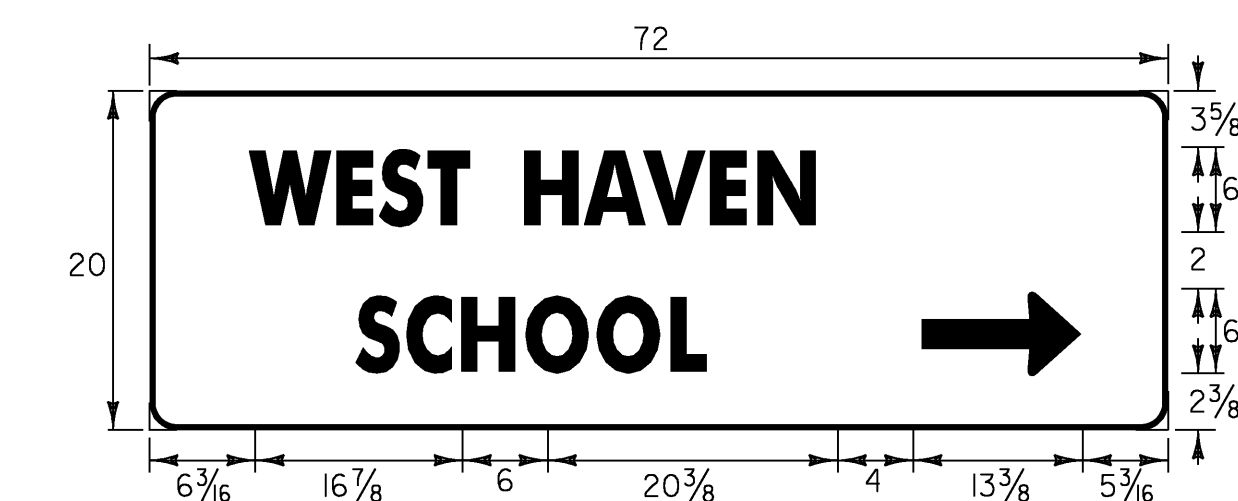

D1-2 (R)

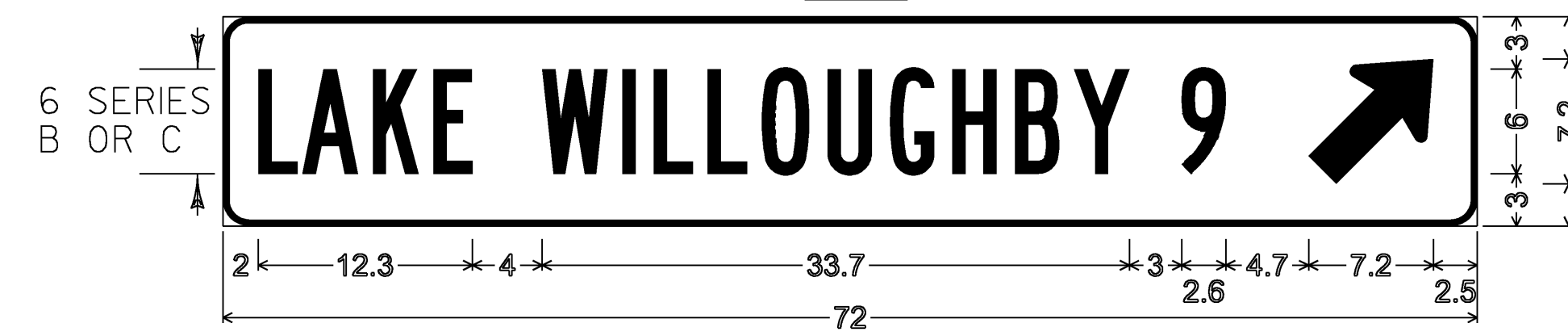

D1-1A

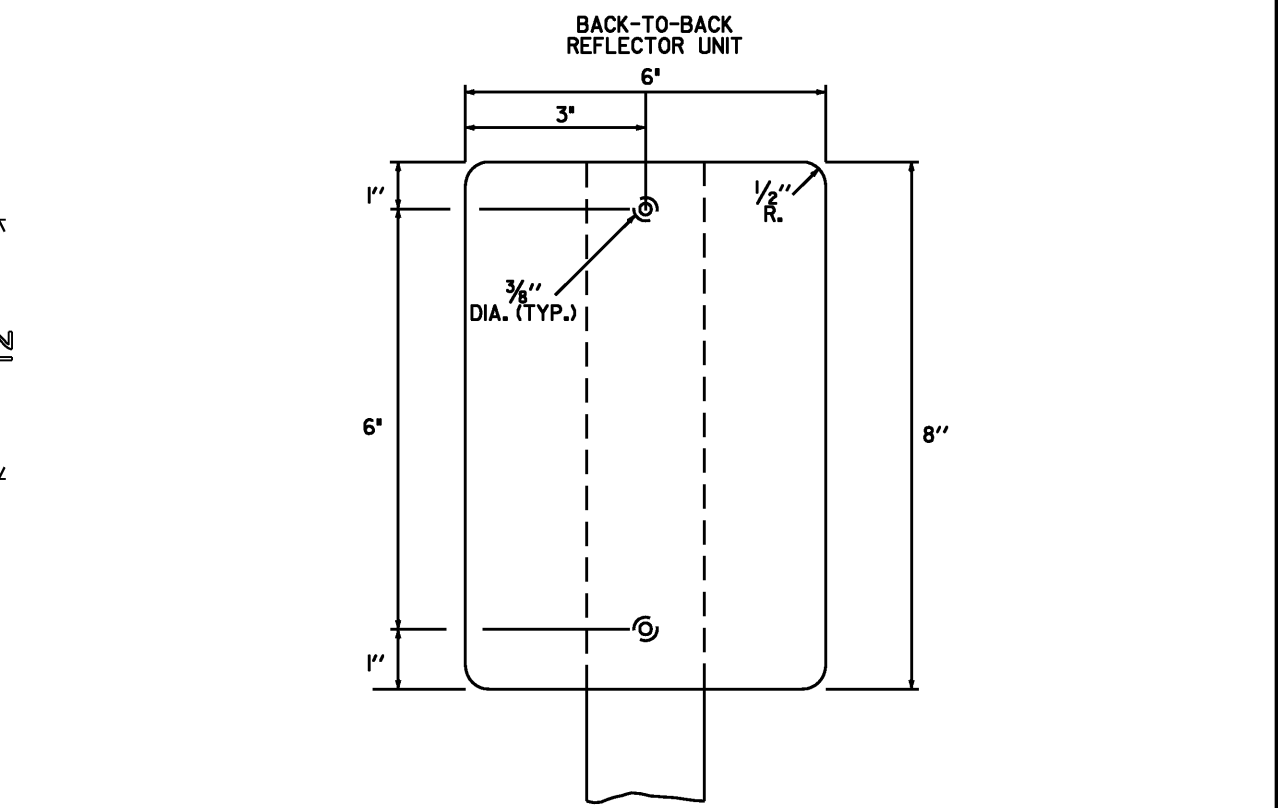

TYPE II (6'x8')

DELINEATORS WITH REFLECTIVE SHEETING

MATERIAL FOR RETROREFLECTIVE SHEETING FOR DELINEATORS SHALL BE A 0.063" ALUMINUM BACKING WITH A WHITE ASTM TYPE III OR TYPE IV.



D1-1A

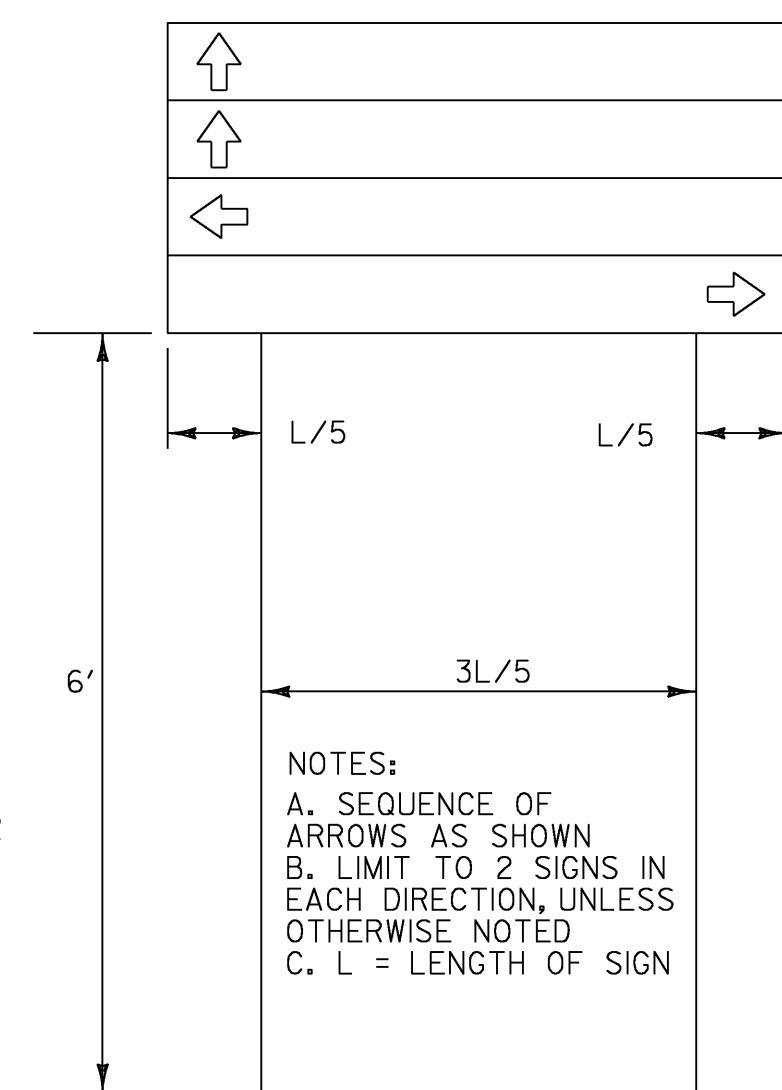

DESTINATION ASSEMBLY

NOTES:
A. SEQUENCE OF ARROWS AS SHOWN
B. LIMIT TO 2 SIGNS IN EACH DIRECTION, UNLESS OTHERWISE NOTED
C. L = LENGTH OF SIGN

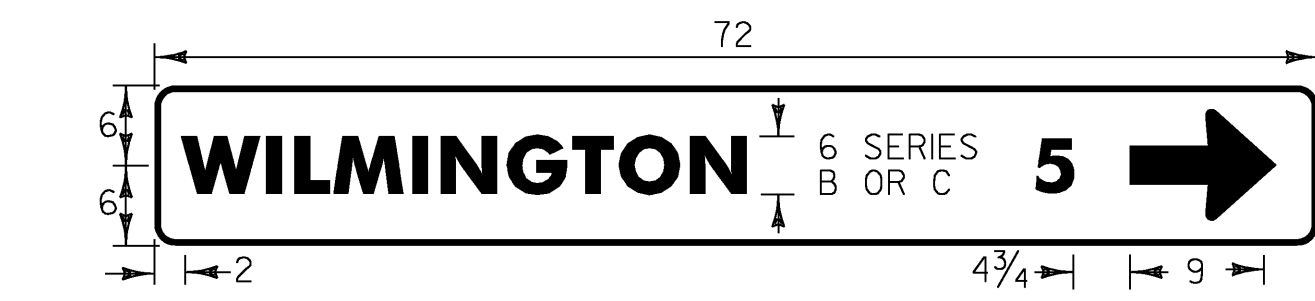

D1-1A

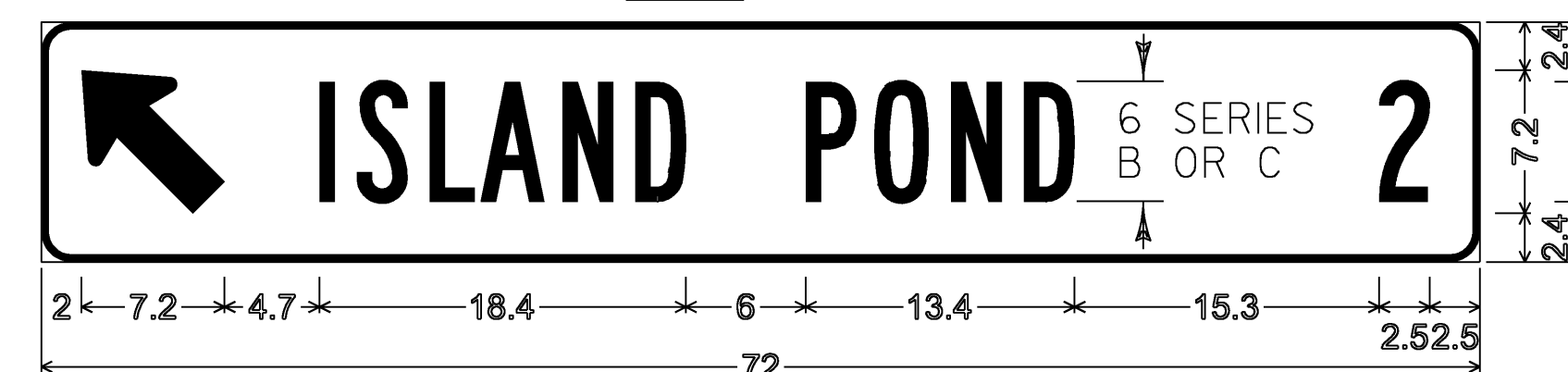

D1-1A

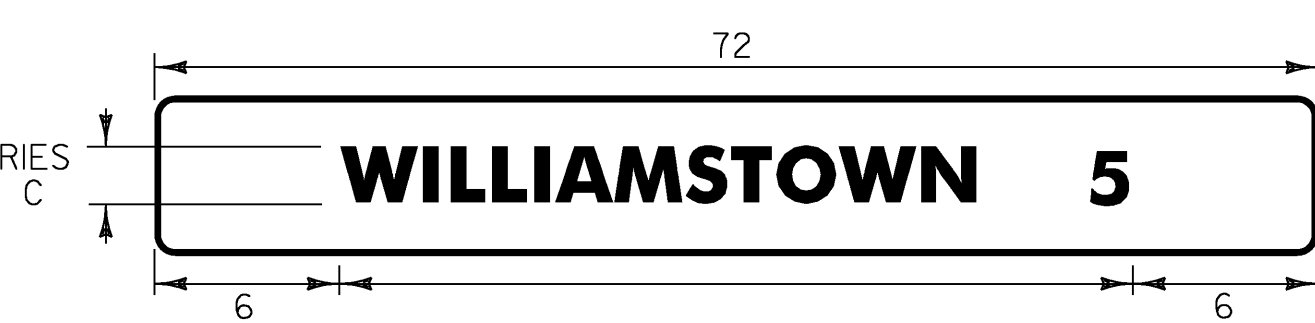

D2-1

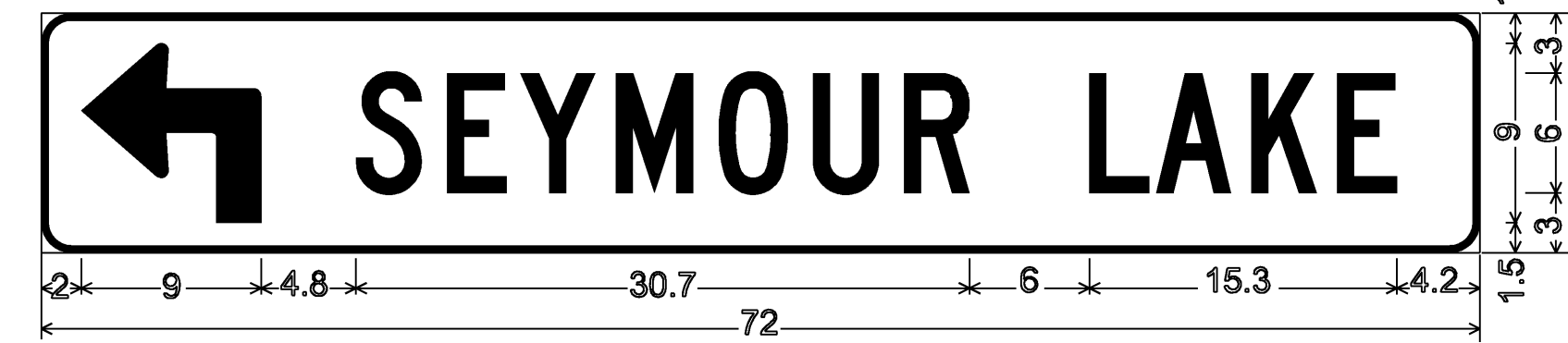

D1-1

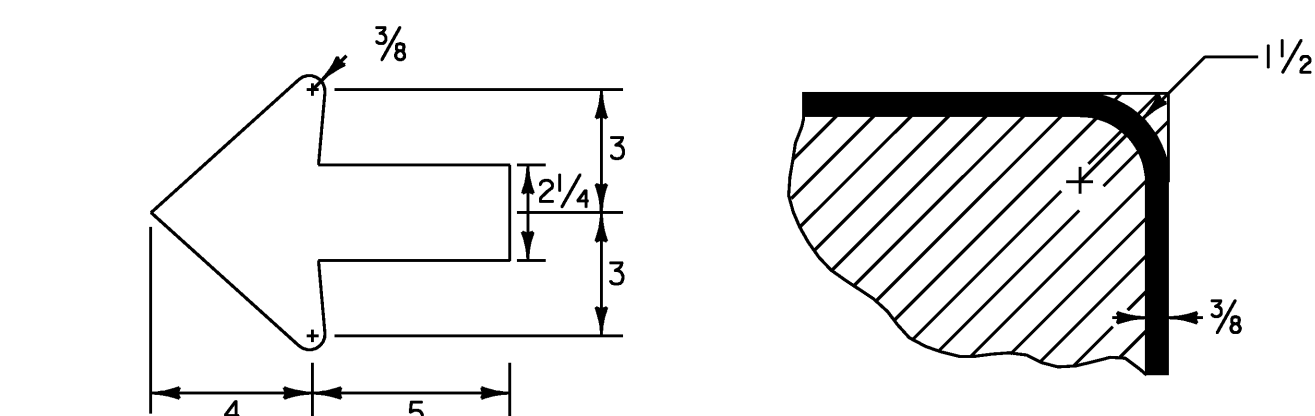

STANDARD ARROW

BORDER DETAIL

**STANDARD DESTINATION SIGN NOTES
D1-1, D1-1A, D1-2, D2-1**

- ALL SIGNS SHALL BE IN ACCORDANCE WITH THE MUTCD AND THE "STANDARD HIGHWAY SIGNS" BOOK (SHS) PUBLISHED BY THE FEDERAL HIGHWAY ADMINISTRATION (FHWA).
- THE SIGN BASE MATERIAL FOR STANDARD DESTINATION SIGNS SHALL BE HIGH DENSITY OVERLAYED PLYWOOD 5/8 INCH THICK OR FLAT SHEET ALUMINUM 1/8 INCH THICK.
- THE DESTINATION SIGNS SHOWN ON THIS SHEET SHALL HAVE WHITE RETROREFLECTIVE ASTM TYPE III TEXT, ARROWS AND BORDERS ON A GREEN RETROREFLECTIVE ASTM TYPE III BACKGROUND. THE COLORS SHALL CONFORM WITH THE COLORS ADOPTED BY AASHTO AND APPROVED BY THE FHWA.
- MULTIPLE ASSEMBLIES SHALL USE THE SAME SIZE THROUGHOUT. DO NOT MIX AND MATCH OLDER SIGN SIZES WITH NEW SIGN HEIGHTS AND WIDTHS.
- ALL DIMENSIONS SHOWN IN INCHES EXCEPT WHERE NOTED.

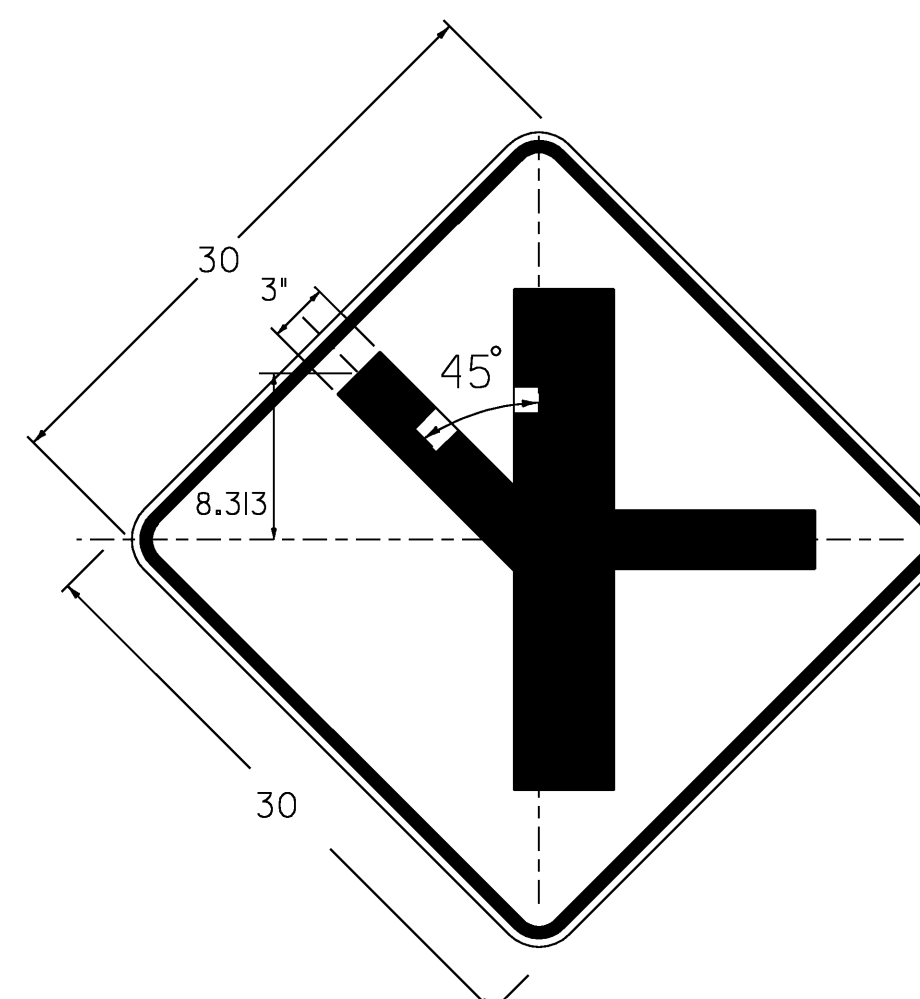

W2-1MJ L(R)

DIMENSIONS NOT SHOWN FOR THIS DETAIL SHALL CONFORM TO THE LATEST EDITION OF THE 2003 MUTCD FOR SIGN DETAIL W1-1. UNLESS OTHERWISE NOTED FOR THIS DETAIL

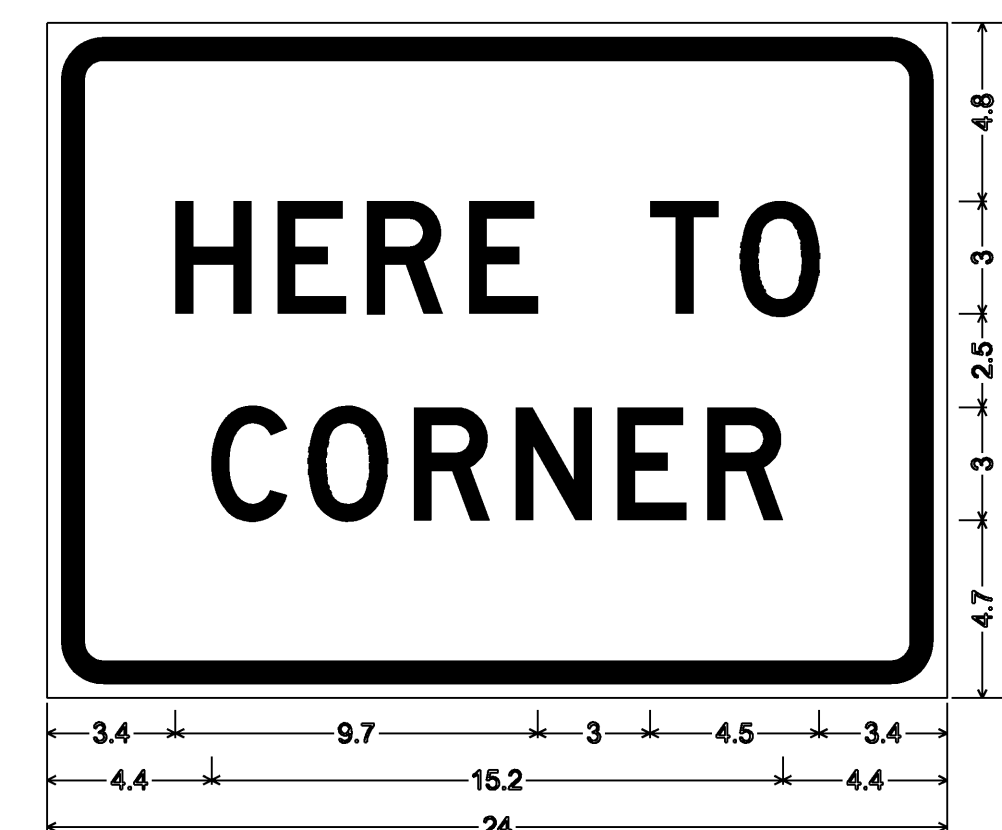

VR-345p

1.5" RADIUS, 0.625" BORDER, 0.375" INDENT
COLORS: LEGEND - RED
BACKGROUND - WHITE
TEXT STYLE: "HERE TO"; "CORNER" D

PROJECT NAME:	HARTFORD - EAST MONTPELIER
PROJECT NUMBER:	STPG SIGN (21)
FILE NAME:	09c024_TS.DGN
PROJECT LEADER:	N. AVERY
DESIGNED BY:	N. AVERY
SIGN DETAILS I	
PLOT DATE:	11-JUN-2009
DRAWN BY:	N. AVERY
CHECKED BY:	A. GAMBLE
SHEET	5 OF 162

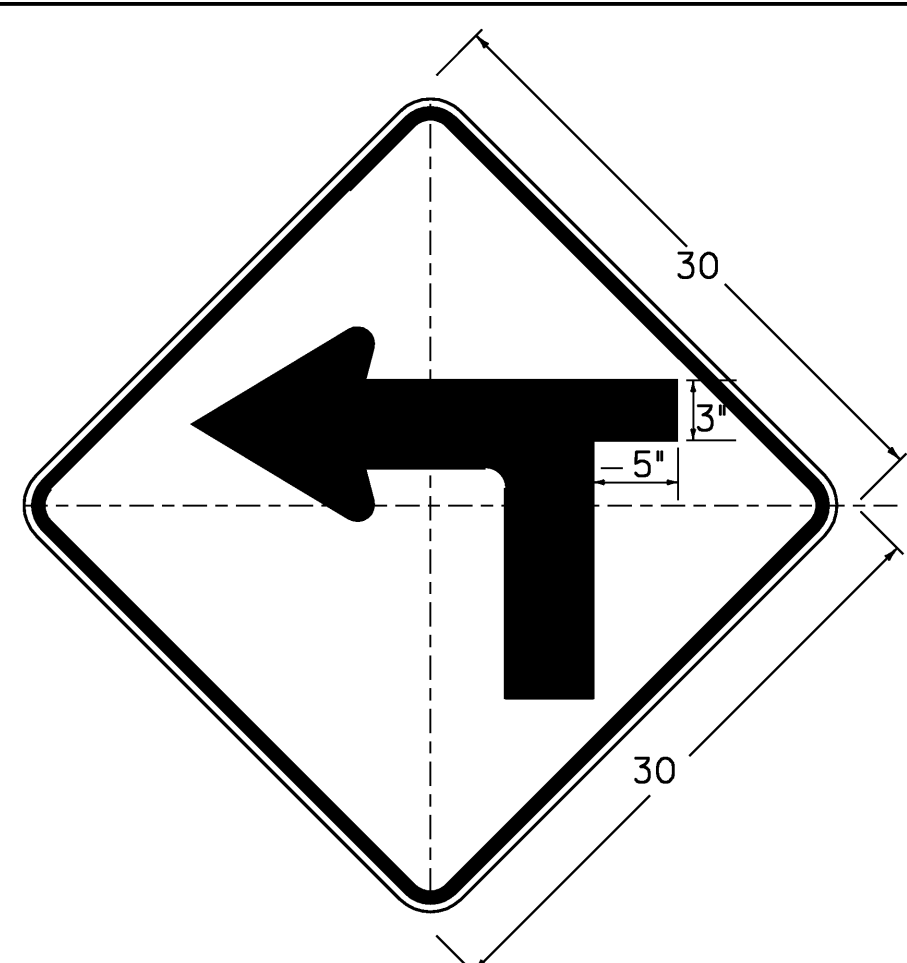

W1-1Ma L(R)

DIMENSIONS NOT SHOWN
FOR THIS DETAIL SHALL CONFORM
TO THE LATEST EDITION OF THE 2003 MUTCD
FOR SIGN DETAIL W1-1.
UNLESS OTHERWISE NOTED FOR THIS DETAIL

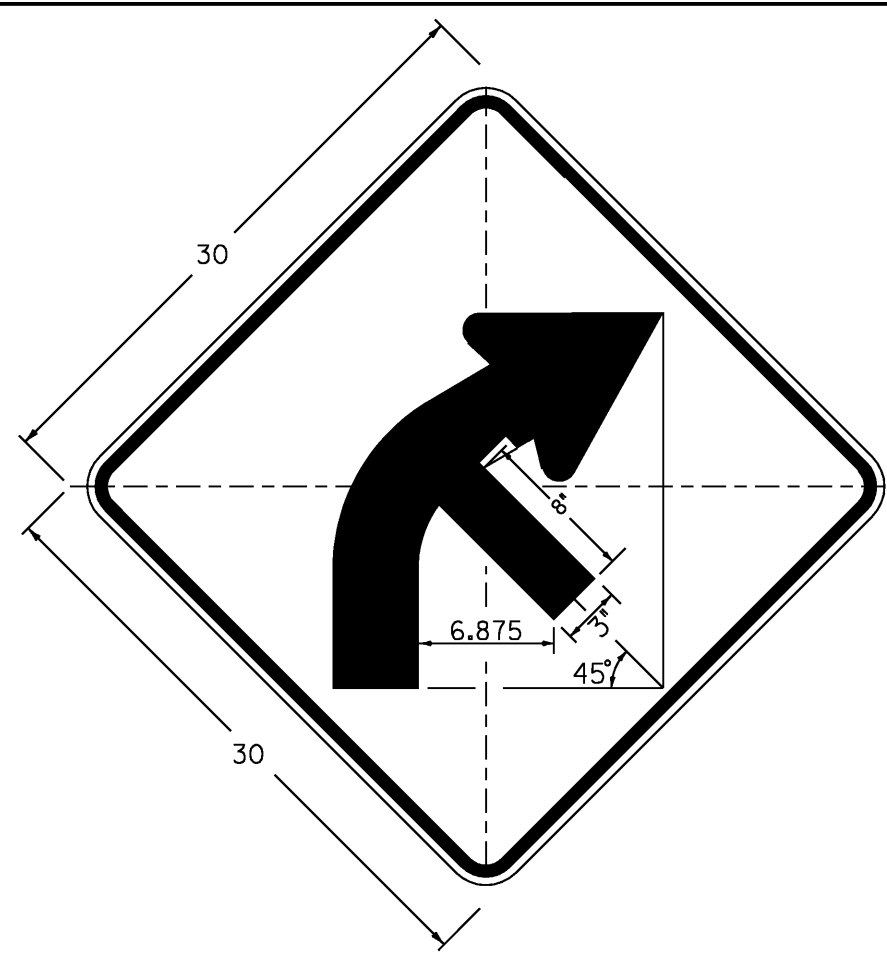

W1-2Mb R(L)

DIMENSIONS NOT SHOWN
FOR THIS DETAIL SHALL CONFORM
TO THE LATEST EDITION OF THE 2003 MUTCD
FOR SIGN DETAIL W1-2.
UNLESS OTHERWISE NOTED FOR THIS DETAIL

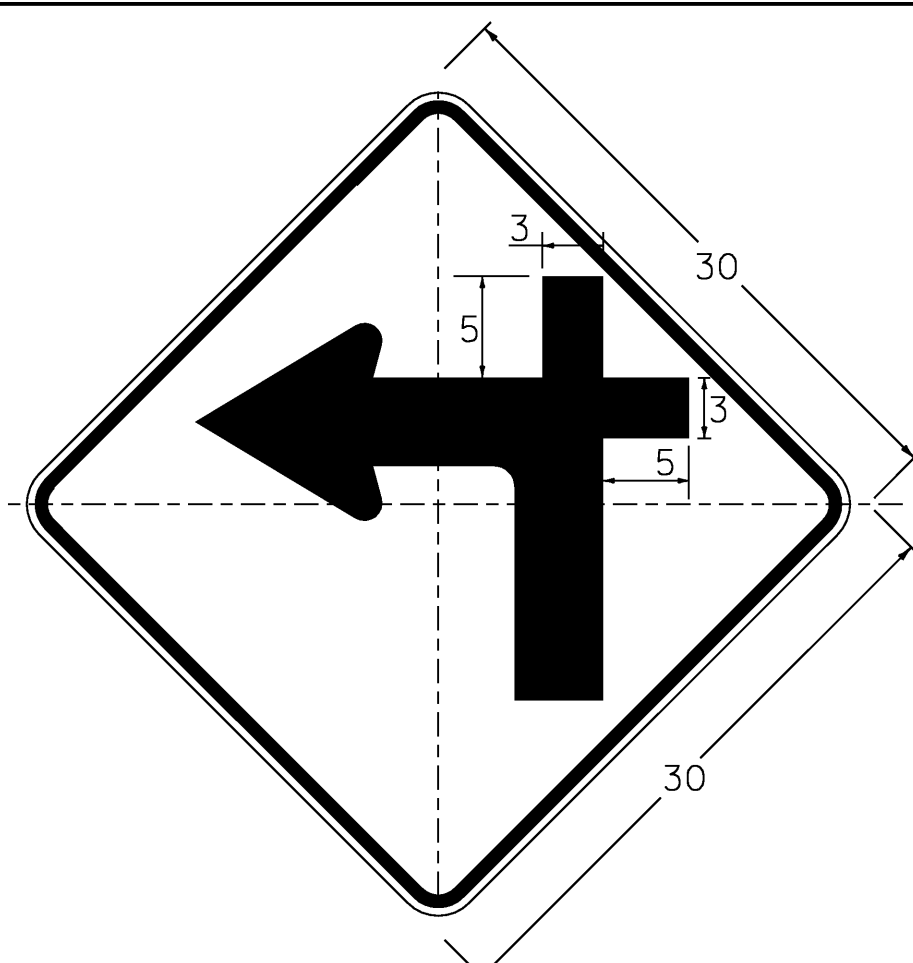

W1-1Mc L(R)

DIMENSIONS NOT SHOWN
FOR THIS DETAIL SHALL CONFORM
TO THE LATEST EDITION OF THE 2003 MUTCD
FOR SIGN DETAIL W1-1.
UNLESS OTHERWISE NOTED FOR THIS DETAIL

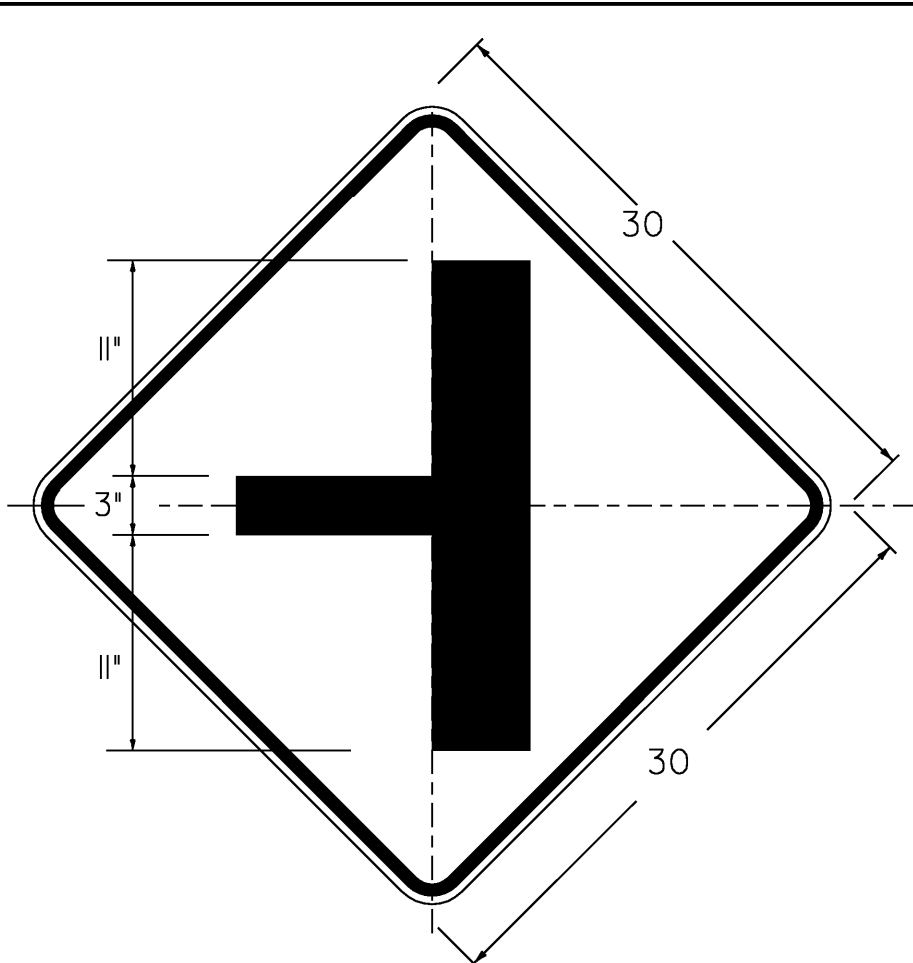

W2-2Ma L(R)

DIMENSIONS NOT SHOWN
FOR THIS DETAIL SHALL CONFORM
TO THE LATEST EDITION OF THE 2003 MUTCD
FOR SIGN DETAIL W2-2.
UNLESS OTHERWISE NOTED FOR THIS DETAIL

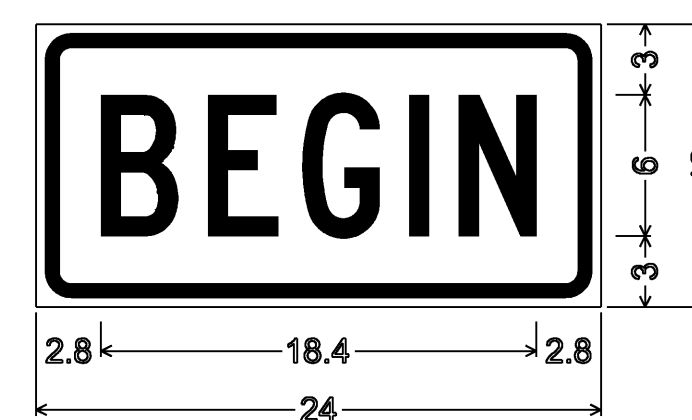

VR-644p

1.5" RADIUS, 0.625" BORDER, 0.375" INDENT
COLORS: LEGEND - RED
BACKGROUND - WHITE
TEXT STYLE: "BEGIN" C

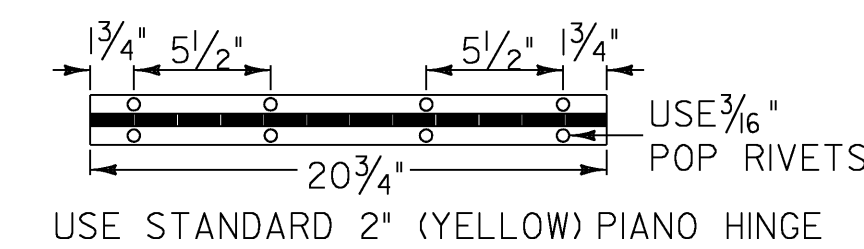

USE STANDARD 2" (YELLOW) PIANO HINGE
USE 3/16" POP RIVETS

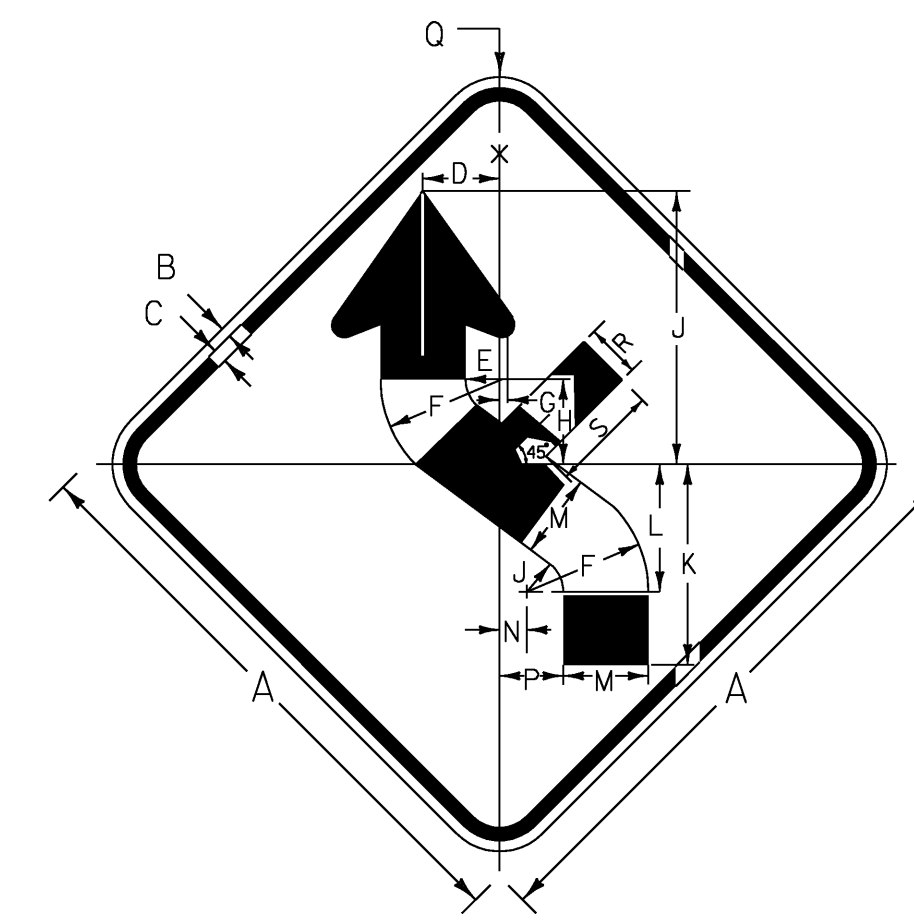

W1-4ML(R)

COLORS: LEGEND - BLACK
BACKGROUND - YELLOW

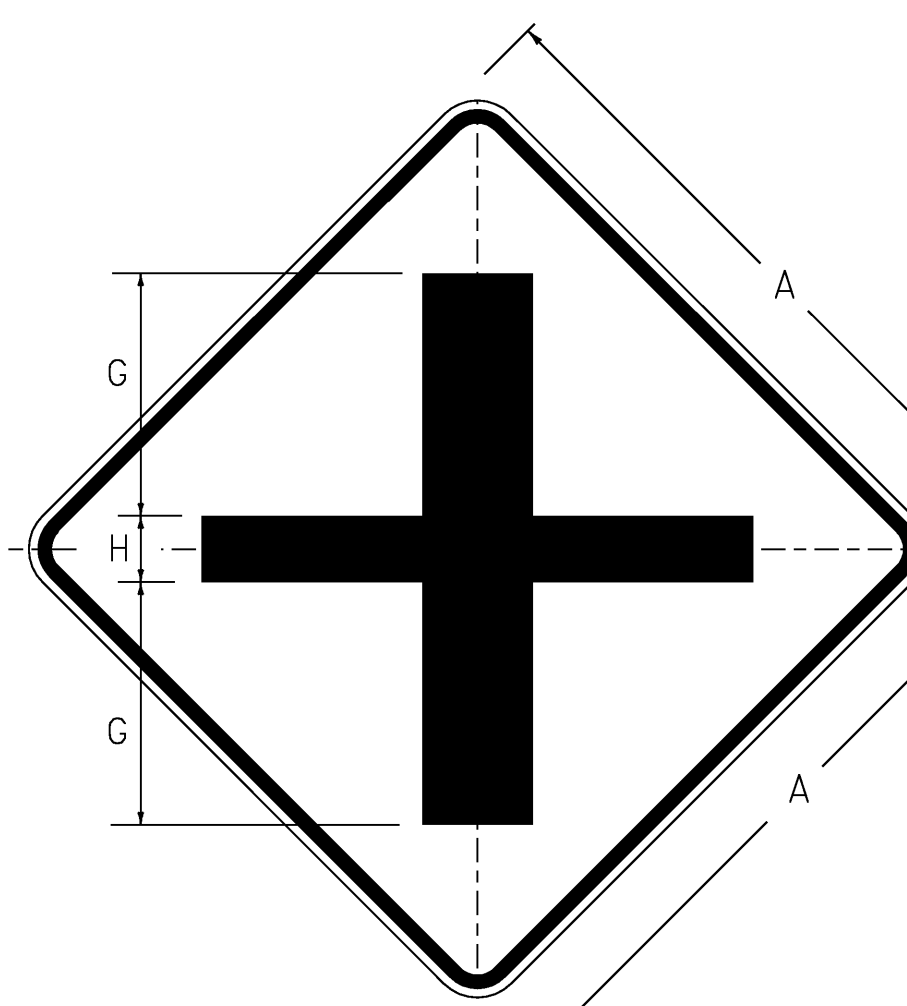

W2-1Mb

DIMENSIONS NOT SHOWN
FOR THIS DETAIL SHALL CONFORM
TO THE LATEST EDITION OF THE 2003 MUTCD
FOR SIGN DETAIL W2-1.
UNLESS OTHERWISE NOTED FOR THIS DETAIL

SIGN	DIMENSIONS (IN)		
	A	G	H
MIN & STD.	30	11	3
SPECIAL	36	13	4



VW-268

COLORS: LEGEND - BLACK
BACKGROUND - YELLOW
* REDUCE SPACING BY 25%

SIGN	DIMENSIONS (INCHES)										
	A	B	C	D	E	F	G	H	J	K	L
STD.	30	3/8	5/8	5B*	3 3/4	1 3/4	5C*	1 7/8	15 1/4	8 5/8	
MIN	30	3/8	5/8	5B*	3 3/4	1 3/4	5C*	1 7/8	15 1/4	8 5/8	
STD	36	5/8	7/8	6B	4	2	6C*	2 1/4	18 1/2	10 1/2	



VW-353

COLORS: LEGEND - BLACK
BACKGROUND - YELLOW

SIGN	DIMENSIONS (INCHES)										
	A	B	C	D	E	F	G	H	J	K	L
STD.	30	1/2	3/4	5D	2 5/8	6 1/8	6 1/8	9 5/8	1 7/8		
EXPWY	36	3/8	7/8	6D	3 1/4	8	7 1/2	12 1/4	2 1/4		
FWY	48	3/4	1 1/4	8D	4	8 1/2	10 1/2	17 1/2	3		

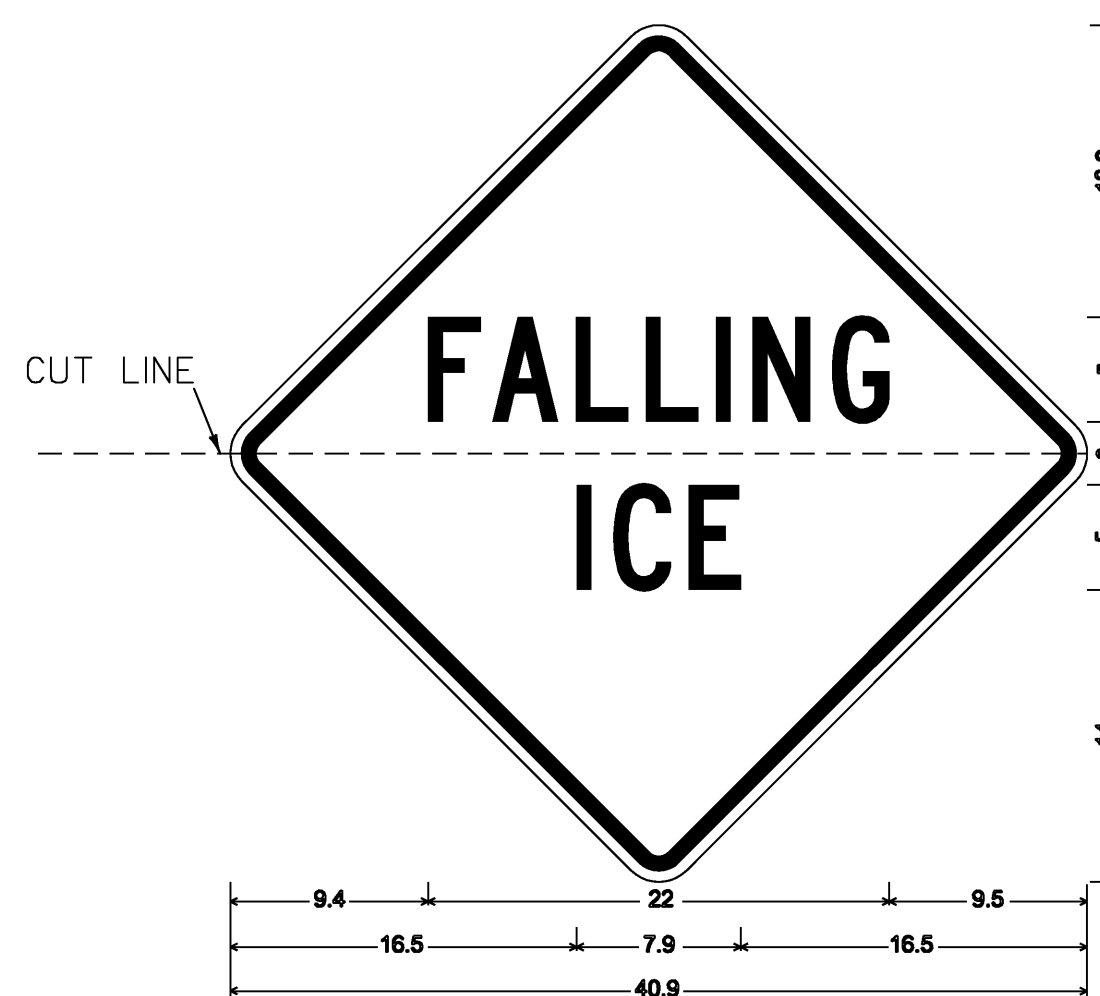

30" X 30" SIGN FACE
1.875" RADIUS, 0.75" BORDER, 0.50" INDENT
COLORS: LEGEND - BLACK
BACKGROUND - YELLOW
TEXT STYLE: "FALLING" C; "ICE" C

VW-347-H

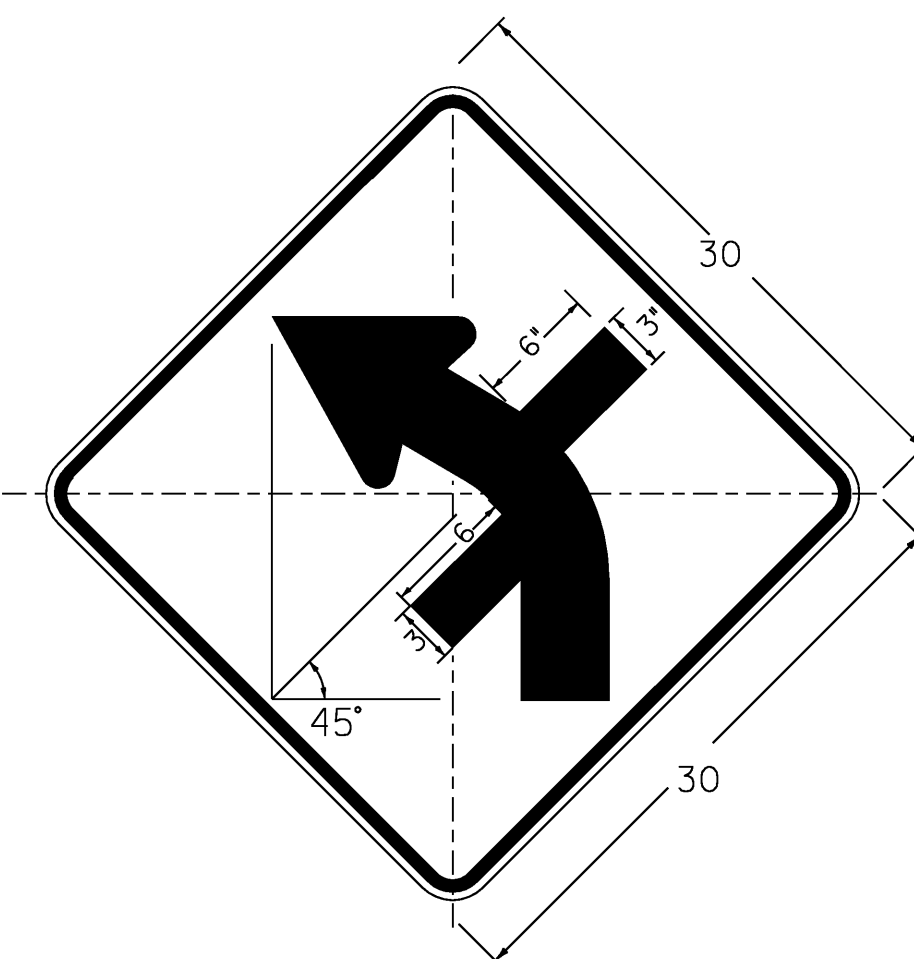

W1-2Mk R(L)

DIMENSIONS NOT SHOWN
FOR THIS DETAIL SHALL CONFORM
TO THE LATEST EDITION OF THE 2003 MUTCD
FOR SIGN DETAIL W1-2.
UNLESS OTHERWISE NOTED FOR THIS DETAIL

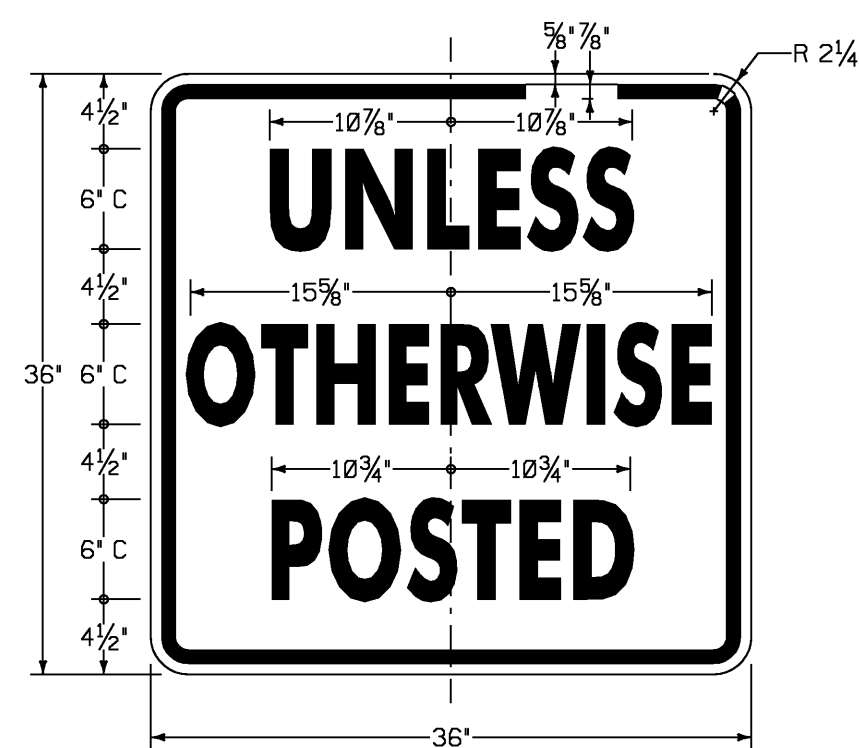

VR-208

COLORS: LEGEND - BLACK
BACKGROUND - WHITE



R2-1

1.5" RADIUS, 0.625" BORDER, 0.375" INDENT
COLORS: LEGEND - BLACK
BACKGROUND - WHITE
TEXT STYLE: "SPEED" E; "LIMIT" E; "40" E



VR-023b

* REDUCE SPACING 40%
** REDUCE SPACING 60%
COLORS: LEGEND - BLACK
BACKGROUND - WHITE

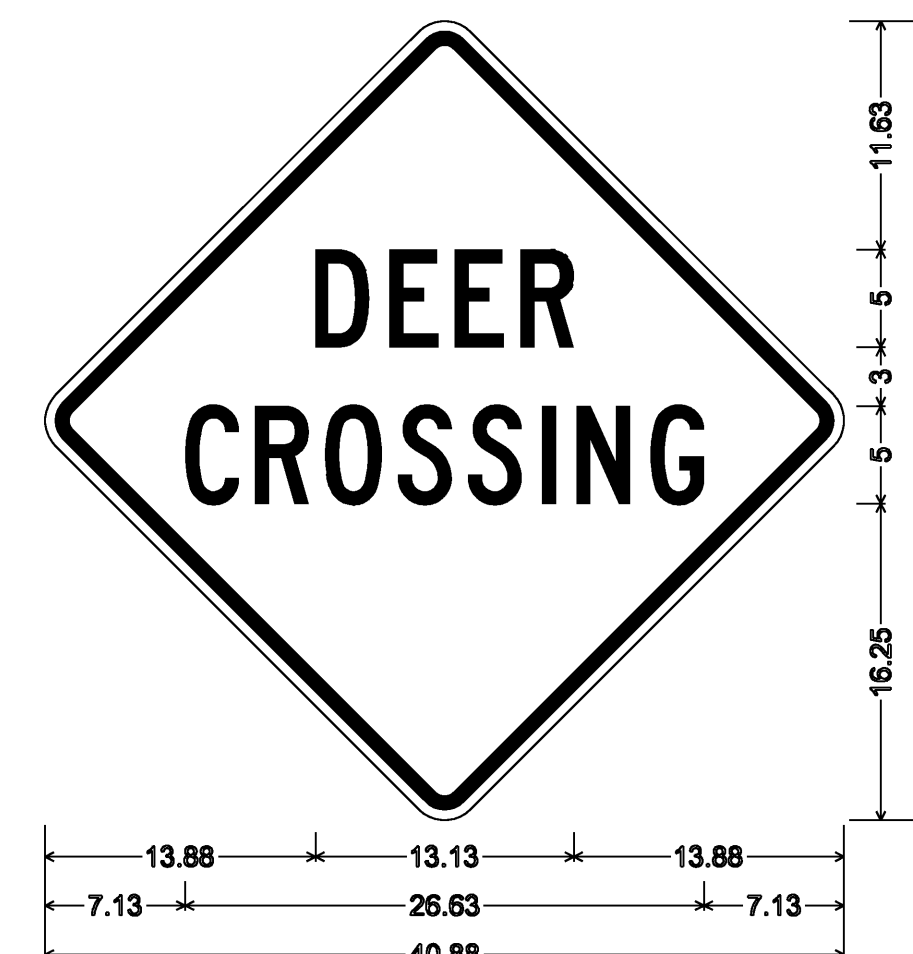

W11-3A

30" X 30" SIGN FACE
1.875" RADIUS, 0.75" BORDER, 0.50" INDENT
COLORS: LEGEND - BLACK
BACKGROUND - YELLOW
TEXT STYLE: "DEER" C; "CROSSING" C

SIGN	DIMENSIONS (INCHES)																		
	A	B	C	D	E	F	G	H	J	K	L	M	N	P	Q	R	S		
STD.	30	1/2	3/4	3 5/8	1 7/8	6 1/4	3 3/8	4 3/8	14 1/16	10 5/8	6 3/8	4 3/8	1 3/8	3 3/32	1 7/8	2 1/2	6		
EXPWY	36	5/8	7/8	4 2 3/32	2 1/4	7 1/2	5 1/2	5 1/4	16 3/8	12 3/8	7 7/8	5 1/4	1 1/8	3 1/16	2 1/4	3	8		
FWY	48	3/4	1 1/4	6 5/8	3	10	7 5/8	7	22 1/2	16 1/2	10 1/2	7	2 1/4	5 1/4	3	4	10		

PROJECT NAME:	HARTFORD - EAST MONTPELIER	PLOT DATE:	11-JUN-2009
PROJECT NUMBER:	STPG SIGN (21)	DRAWN BY:	N. AVERY
FILE NAME:	09c024_TS.DGN	CHECKED BY:	A. GAMBLE
PROJECT LEADER:	N. AVERY	SIGN DETAILS 2	SHEET 6 OF 162

ROUTE MARKER ASSEMBLY FRAMES

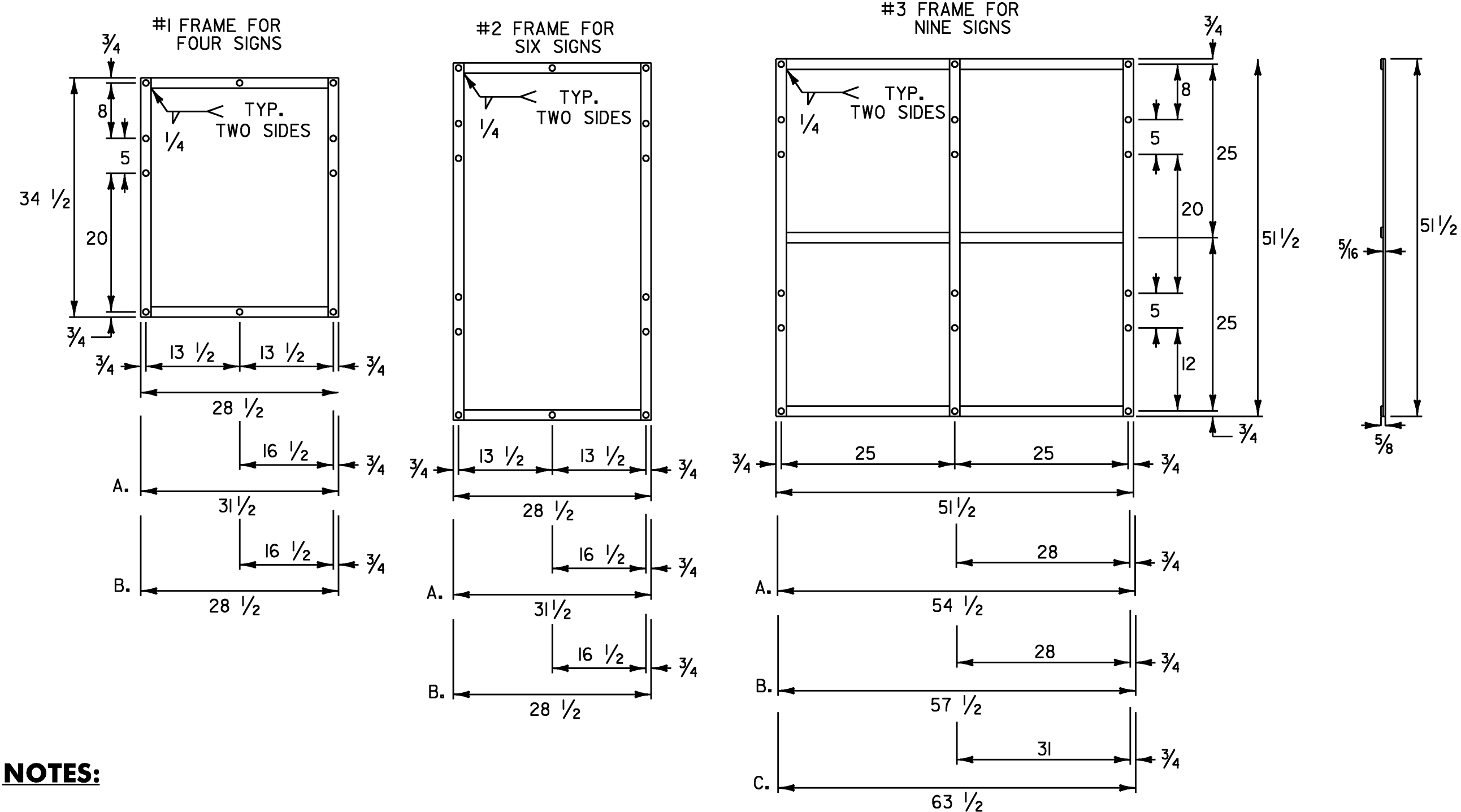

NOTES:

- NOTES FOR #1 AND #2 FRAME:
 - WITH ONE 30 INCH THREE DIGIT SIGN
 - WITH TWO 30 INCH THREE DIGIT SIGNS
- NOTES FOR #3 FRAME:
 - WITH ONE 30 INCH THREE DIGIT SIGN IN AN OUTSIDE POSITION.
 - WITH ONE 30 INCH THREE DIGIT SIGN IN THE CENTER POSITION OR TWO SUCH SIGNS IN THE OUTSIDE POSITIONS.
 - WITH THREE 30 INCH THREE DIGIT SIGNS.
- ALL HOLES SHALL BE 3/16 INCH DIAMETER. FOR OTHER SIGN COMBINATIONS, THAN ABOVE, THE FRAME DIMENSIONS AND HOLE SPACING SHALL BE MODIFIED AS NECESSARY. THE FRAME SHALL BE PAINTED WITH ONE COAT OF PRIMER AND A SECOND COAT OF BLACK PAINT. THE PAINT SHALL BE OF THE TYPE USED ON EXTERIOR METAL SURFACES TO PREVENT METAL CORROSION.
- STANDARD FRAMES SHALL BE 5/16 INCH x 1 1/2 INCH WELDED A-36 STEEL.
- ALL DIMENSIONS SHOWN IN INCHES UNLESS OTHERWISE NOTED.

STANDARD MOUNTING OF ROUTE MARKER ASSEMBLIES

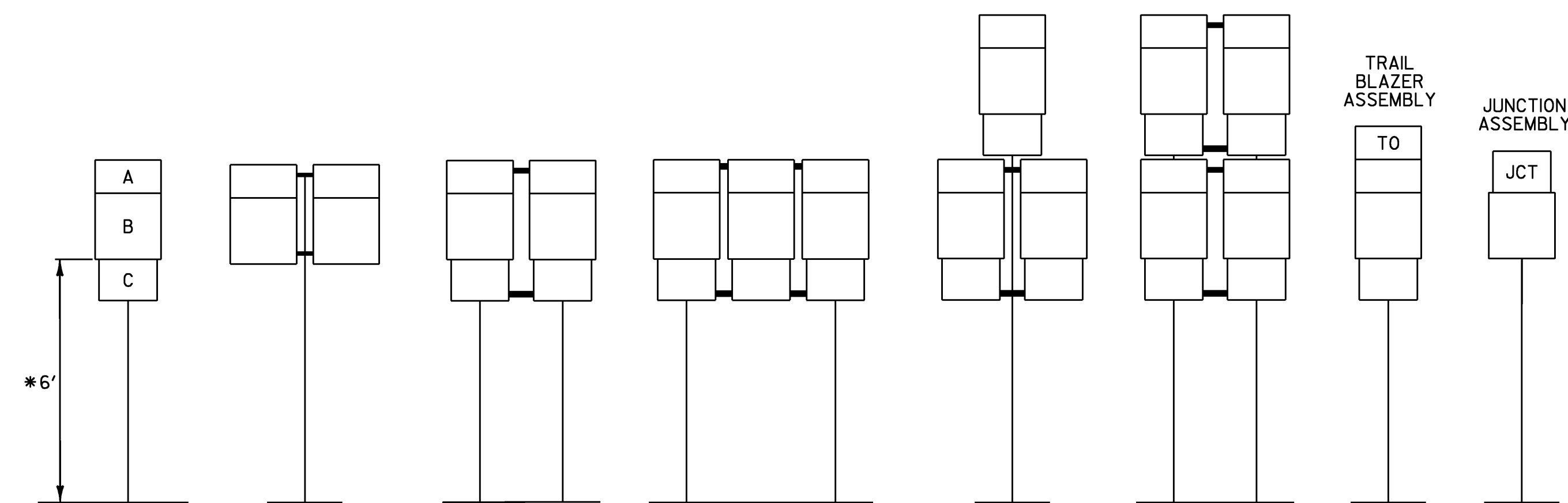

- A - CARDINAL DIRECTION MARKER
- B - ROUTE NUMBER
- C - ADVANCE TURN ARROW OR DIRECTIONAL ARROW

* WHERE PARKING OR PEDESTRIAN TRAFFIC WILL OCCUR IN THE IMMEDIATE VICINITY OF THESE SIGNS MINIMUM VERTICAL CLEARANCE SHALL BE INCREASED TO SEVEN FEET

INSTALLATION SEQUENCE:

IN MULTIPLE HORIZONTAL MOUNTINGS PLACE A ROUTE MARKER ASSEMBLY INDICATING A LEFT TURN ON THE LEFT SIDE OF THE ASSEMBLY; RIGHT TURN ON THE RIGHT SIDE. FOR VERTICALLY STACKED MOUNTINGS PLACE THE STRAIGHT THROUGH MOVE INDICATION ON TOP, THE LEFT OR RIGHT TURNS AS APPROPRIATE BENEATH.

NOTES:

- ALL DIMENSIONS SHOWN IN INCHES UNLESS OTHERWISE NOTED.
- VERTICAL FRAME MEMBERS SHALL LINE UP WITH SIGN POST ON WHICH THEY ARE MOUNTED.

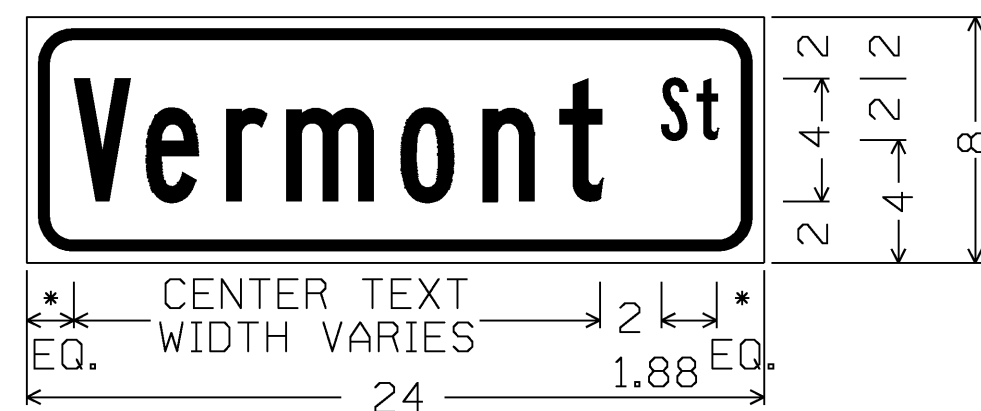

1.5" RADIUS, 0.375" BORDER, 0.375" INDENT
 COLORS: LEGEND - BLACK
 BACKGROUND - YELLOW
 TEXT STYLE: B

* LATERAL SPACING TO OUTSIDE OF PANEL SHALL BE A MINIMUM OF 1.5"

W16-8



1.5" RADIUS, 0.375" BORDER, 0.375" INDENT
 COLORS: LEGEND - BLACK
 BACKGROUND - YELLOW
 TEXT STYLE: B

* LATERAL SPACING TO OUTSIDE OF PANEL SHALL BE A MINIMUM OF 1.5"

W16-8



1.5" RADIUS, 0.375" BORDER, 0.375" INDENT
 COLORS: LEGEND - BLACK
 BACKGROUND - YELLOW
 TEXT STYLE: B

* LATERAL SPACING TO OUTSIDE OF PANEL SHALL BE A MINIMUM OF 1.5"

W16-8

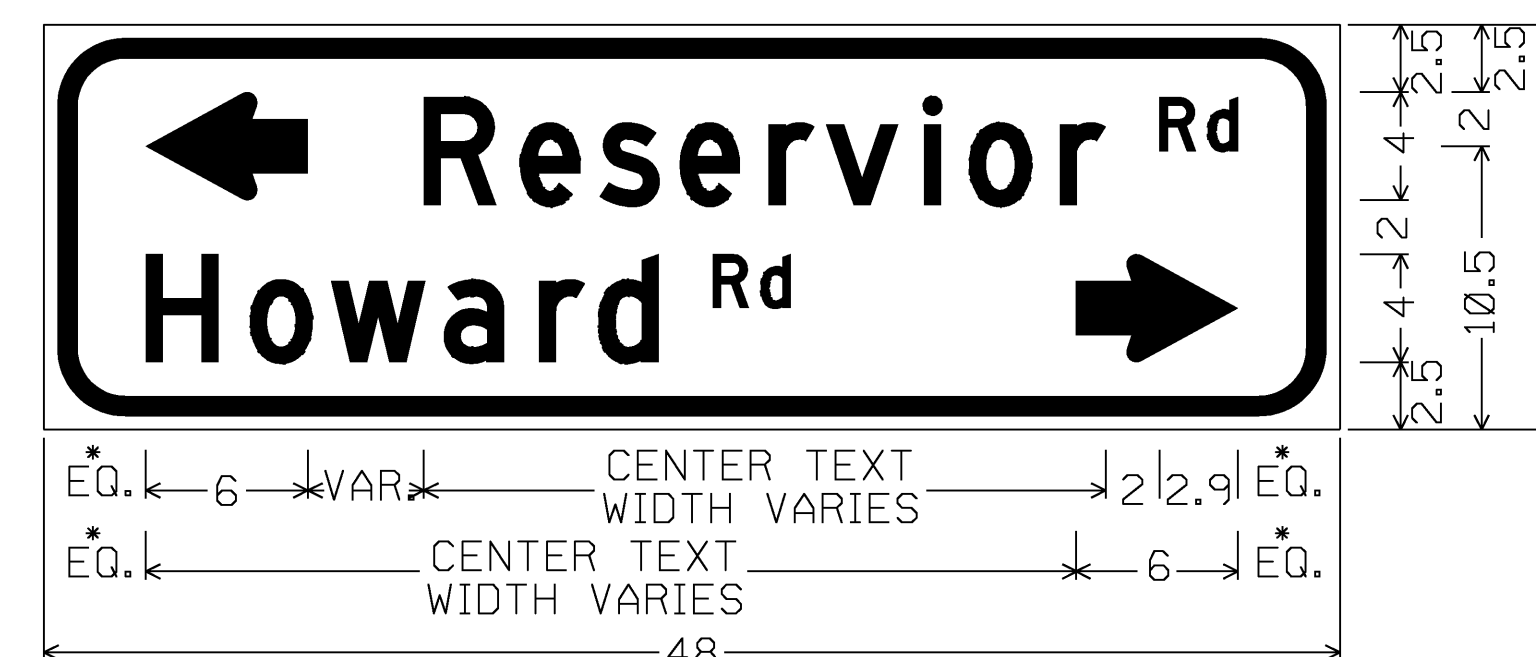



3" RADIUS, 0.75" BORDER, 0.50" INDENT
 COLORS: LEGEND - BLACK
 BACKGROUND - YELLOW
 TEXT STYLE: D; STANDARD ARROW CUSTOM 6" WIDE X 4" HIGH

* LATERAL SPACING TO OUTSIDE OF PANEL SHALL BE A MINIMUM OF 3"



W16-8a





PROJECT NAME: HARTFORD - EAST MONTPELIER
 PROJECT NUMBER: STPG SIGN (21)



FILE NAME: 09c024_TS.DGN PLOT DATE: 11-JUN-2009
 PROJECT LEADER: N. AVERY DRAWN BY: N. AVERY
 DESIGNED BY: N. AVERY CHECKED BY: A. GAMBLE
 GUIDE SIGN ASSEMBLY SHEET 7 OF 162



DIRECTION	MILEPOINT	LOCATION CODE (SHEET 2)	SIGN CODE	WIDTH (IN)	HEIGHT (IN)	SHEETING REMARKS	SIGN LEGEND FOR ALL INSTALLATION DATES AND POST LENGTHS SEE ORIGINAL RECORD PLANS	NEW SIGNS		EXISTING SIGNS				EXIST POST		NUMBER OF NEW POSTS	SQUARE STEEL (IN)			TUBULAR STEEL Ø (IN)				SIGN FRAME REQUIRED	REMARKS	SIGN DETAIL			
								"A"	"B"	RETAIN	SALVAGE FROM	SALVAGE TO	REMOVE	RETAIN	REMOVE		1.75	2.00	2.50	FOUNDATION	3.00	3.50	4.00			5.00	DETAIL IN SHS	DETAIL ON SHEET NUMBER	DETAIL ON STD SHEET NUMBER
																	(LB / FT)				(LB / FT)								
HARTFORD VT 14							FY-FLUORESCENT YELLOW FYG-FLUORESCENT YELLOW GREEN															"SHS"-STANDARD HIGHWAY SIGNS							
NB	1.481	A	VR-039	24	18		STATE HIGHWAY BEGINS			1																			
		A	R2-1	24	30		SPEED LIMIT 50			1																			
NB	1.533	A	M1-5	24	24		VERMONT 14			1																			
		A	M3-1S	24	12		NORTH			1																			
NB	1.791	C	VR-017	24	24																								
		C	VR-017	24	30			5.00								1		X									E-141		
NB	1.800	D	R1-1	30	30		STOP			1																			
NB	2.074	C	VR-017	24	30																								
		C	VR-017	24	30			5.00								1		X									E-141		
NB	2.082	D	R1-1	30	30		STOP			1																			
NB	3.010	A	VW-205	30	30		WATCH FOR TURNING VEHICLES			1																	SIGN MISSING		
NB	3.220	C	VR-017	24	30		LEGAL LOAD LIMIT 24,000 LBS			1																	BYRON BRYON HILL TH-187		
NB	3.226	D	R1-1	30	30		STOP			1																			
NB	3.726	A	W2-2R	30	30		RIGHT SIDE ROAD			1																			
		A	W16-8A	30	10		RUNNALS RD.			1																	PAINTBALL DAMAGE REDO		
SIGN SUMMARY SHEET							SHEET TOTALS	17.58 40.00	0.00	11	0	0	3 2	0	0	2	30												
VERMONT AGENCY OF TRANSPORTATION							TOWN TOTALS	130.2	0.0	41.0	13.0	9.0	26	0.0	0.0	26	390.0												
																	PROJECT NAME: Hartford-East Montpelier VT14												
																	PROJECT NUMBER: STPG SIGN(21)												
																	FILE NAME: Hartford.xls	PLOT DATE: 6/10/2009											
																	PROJECT MANAGER: N. Avery	DRAWN BY: I. Shea											
																	DESIGNED BY: D. Crosslev	CHECKED BY: S. Menard											
																	HARTFORD SHEET 1	SHEET 8 OF 162											

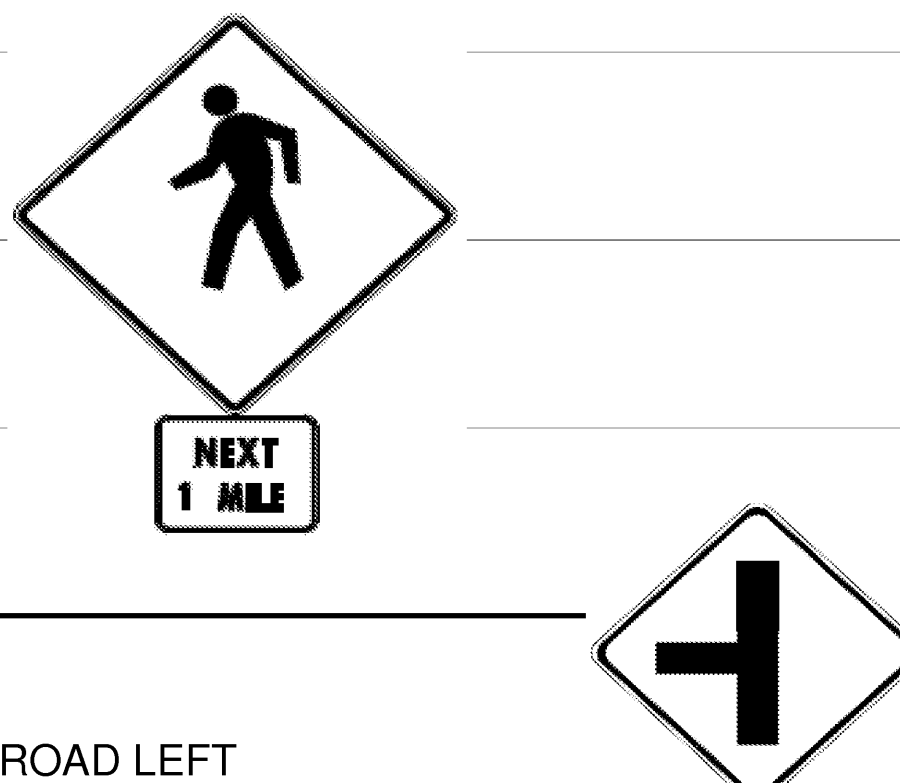

DIRECTION	MILEPOINT	LOCATION CODE (SHEET 2)	SIGN CODE	WIDTH (IN)	HEIGHT (IN)	SHEETING REMARKS	SIGN LEGEND FOR ALL POST LENGTHS AND INSTALLATION DATES SEE ORIGINAL RECORD PLANS	NEW SIGNS		EXISTING SIGNS				EXIST POST		NUMBER OF NEW POSTS	SQUARE STEEL (IN)			TUBULAR STEEL Ø (IN)				SIGN FRAME REQUIRED	REMARKS	SIGN DETAIL			
								"A"	"B"	RETAIN	SALVAGE FROM	SALVAGE TO	REMOVE	RETAIN	REMOVE		1.75	2.00	2.50	FOUNDATION	3.00	3.50	4.00			5.00	DETAIL IN SHS	DETAIL ON SHEET NUMBER	DETAIL ON STD SHEET NUMBER
																	(LB / FT)				(LB / FT)								
HARTFORD VT 14							FY-FLUORESCENT YELLOW FYG-FLUORESCENT YELLOW GREEN															"SHS"-STANDARD HIGHWAY SIGNS							
NB	3.841	C	VR-017	24	30		LEGAL LOAD LIMIT 24,000 LBS			1					X										RUNNELS RD TH-22				
NB	3.847	D	R1-1	30	30		STOP			1					X														
NB	4.334	A	W1-2R	30	30		RIGHT CURVE				1					X													
		A	W13-1	24	24		40 MPH PLAQUE				1																		
NB	4.360	A	W1-2R	30	30		RIGHT CURVE				+	1				X													
		A	W13-1	24	24		40 MPH PLAQUE				+	1					1												
NB	4.440	A	OM-3R	12	36		RIGHT OBJECT MARKER			1					X														
NB	4.734	A	W1-10R	30	30		MODIFIED RIGHT CURVE			1					X														
		A	W16-8A	30	10		JERICO ST.			1																			
NB	4.832	C	VR-017	24	30		LEGAL LOAD LIMIT 16,000 LBS			1					X														
NB	4.842	D	R1-1	30	30		STOP			1					X														
NB	4.990	C	VR-017	24	30		LEGAL LOAD LIMIT 16,000 LBS			1					X														
NB	5.011	D	R1-1	30	30		STOP			1					X														
NB	5.783	A	W1-2L	30	30		LEFT CURVE	6.25		1			1		X														
NB	5.830	A	VW-133R	30	30		HIDDEN DRIVES RIGHT	6.25		1			1		X														
SIGN SUMMARY SHEET							SHEET TOTALS	12.5 0.00	0.00	11	2 4	2 0	2 0	0	0	1 0	0												
VERMONT AGENCY OF TRANSPORTATION							TOWN TOTALS	130.2	0.0	41.0	13.0	9.0	26	0.0	0.0	26	390.0												
PROJECT NAME: Hartford-East Montpelier VT14																					PROJECT NUMBER: STPG SIGN(21)								
FILE NAME: Hartford.xls															PLOT DATE: 6/10/2009			DRAWN BY: I. Shea											
PROJECT MANAGER: N. Avery															DESIGNED BY: D. Crossley			CHECKED BY: S. Menard											
HARTFORD SHEET 2																					SHEET 9 OF 162								



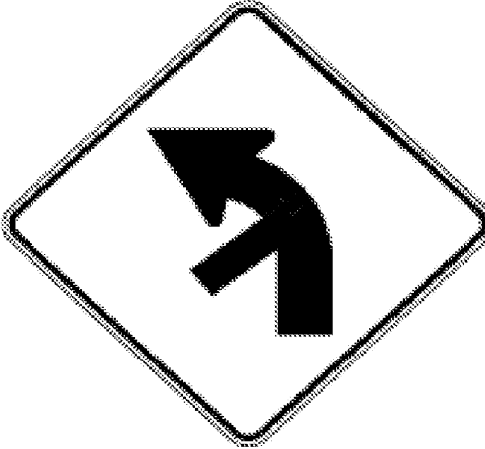

DIRECTION	MILEPOINT	LOCATION CODE (SHEET 2)	SIGN CODE	WIDTH (IN)	HEIGHT (IN)	SHEETING REMARKS	SIGN LEGEND FOR ALL POST LENGTHS AND INSTALLATION DATES SEE ORIGINAL RECORD PLANS	NEW SIGNS		EXISTING SIGNS				EXIST POST		NUMBER OF NEW POSTS	SQUARE STEEL (IN)			TUBULAR STEEL Ø (IN)				SIGN FRAME REQUIRED	REMARKS	SIGN DETAIL			
								"A"	"B"	RETAIN	SALVAGE FROM	SALVAGE TO	REMOVE	RETAIN	REMOVE		1.75	2.00	2.50	FOUNDATION	3.00	3.50	4.00			5.00	DETAIL IN SHS	DETAIL ON SHEET NUMBER	DETAIL ON STD SHEET NUMBER
																	(LB / FT)				(LB / FT)								
HARTFORD VT 14							FY-FLUORESCENT YELLOW FYG-FLUORESCENT YELLOW GREEN															"SHS"-STANDARD HIGHWAY SIGNS							
NB	6.040	C	VR-398	24	30		NO PARKING THIS SIDE																						
NB	6.350	A	W3-5	36	36		SPEED REDUCTION SPEED LIMIT 35	9.00		1				1		X										SHOTGUN DAMAGE REDO			
NB	6.400	A	VD-018	30	18																							E-128B	
		A	VD-018	30	18			3.75							1			X											
NB	6.460	A	W1-4R	30	30		RIGHT REVERSE CURVE			1						X													
NB	6.483	A	R2-1	24	30																								
		A	R2-1	30	36			7.50							1			X										6	
NB	6.620	A	W11-2	30	30																								
		A	W7-3A	24	18																								
		A	W11-2	30	30	F-Y-G		6.25								1			X								X		
		A	W7-3A	24	18	F-Y-G		3.00																			X		
NB	6.667	A	R2-1	24	30		SPEED LIMIT 35			1						X													
NB	6.858	A	M3-1S	24	12		NORTH			1						X													
		A	M1-5	24	24		VERMONT 14			1																			
NB	6.978	C	VR-017	24	30		LEGAL LOAD LIMIT 24,000 LBS			1						X											HARPER SAVAGE LN TH-35		
SIGN SUMMARY SHEET							SHEET TOTALS			29.50 20.50	0.00	6	0	0	6	0	0	3	45				PROJECT NAME: Hartford-East Montpelier VT14 PROJECT NUMBER: STPG SIGN(21)						
VERMONT AGENCY OF TRANSPORTATION							TOWN TOTALS			130.2	0.0	41.0	13.0	9.0	26	0.0	0.0	26	390.0				FILE NAME: Hartford.xls	PLOT DATE: 6/10/2009					
										SF	SF	EA	EA	EA	EA	EA	EA	EA	FT				PROJECT MANAGER: N. Avery	DRAWN BY: I. Shea					
																							DESIGNED BY: D. Crosslev	CHECKED BY: S. Menard					
																							HARTFORD SHEET 3	SHEET 10	OF 162				

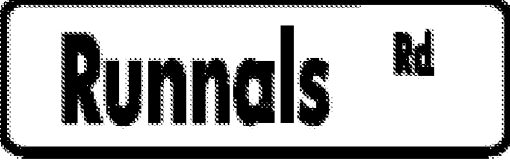



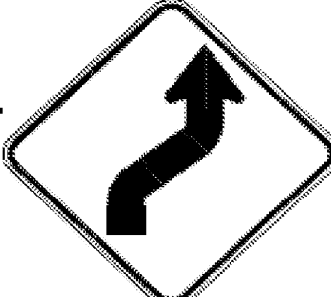

DIRECTION	MILEPOINT	LOCATION CODE (SHEET 2)	SIGN CODE	WIDTH (IN)	HEIGHT (IN)	SHEETING REMARKS	SIGN LEGEND FOR ALL POST LENGTHS AND INSTALLATION DATES SEE ORIGINAL RECORD PLANS	NEW SIGNS		EXISTING SIGNS				EXIST POST		NUMBER OF NEW POSTS	SQUARE STEEL (IN)			TUBULAR STEEL Ø (IN)				SIGN FRAME REQUIRED	REMARKS	SIGN DETAIL			
								"A"	"B"	RETAIN	SALVAGE FROM	SALVAGE TO	REMOVE	RETAIN	REMOVE		1.75	2.00	2.50	FOUNDATION	3.00	3.50	4.00			5.00	DETAIL IN SHS	DETAIL ON SHEET NUMBER	DETAIL ON STD SHEET NUMBER
																	(LB / FT)				(LB / FT)								
HARTFORD VT 14							FY-FLUORESCENT YELLOW FYG-FLUORESCENT YELLOW GREEN															"SHS"-STANDARD HIGHWAY SIGNS							
			B	W1-6	48	24		8.00																X					
NB	7.679		A	W1-6	48	24							1	X															
			A	W1-6	48	24		8.00																X					
NB	7.790		A	S3-1	30	30	SCHOOL BUS STOP AHEAD							1	X														
SB	7.761		F	W1-2R	30	30	RIGHT CURVE				1															SALVAGED TO 7.720 SB			
			F	W13-1	18	18	40 MPH PLAQUE				1																		
SB	7.720		F	W1-2R	30	30	RIGHT CURVE					1			1	X										INSTALL 200' +/- SOUTH OF ORIGINAL LOCATION SALVAGED FROM 7.761 SB			
			F	W13-1	18	18	40 MPH PLAQUE					1																	
SB	7.665		F	W3-5	36	36		9.00							2	X								X		INSTALL OPPOSITE RIGHT ARROW			
SB	7.586		F	R2-5A	24	30							1			X													
SB	7.586		F	VD-018	30	18		3.75							1	X										E-128B			
SB	7.520		F	VD-018	30	18							1			X													
SB	7.530		F	R2-1	30	36		7.50							1	X										INSTALL 0.28 MILES (1478') NORTH OF INTERSECTION TIGER TOWN RD. TH-13			
SB	7.440		F	R2-1	24	30								1		X									6				
SB	7.360		F	W2-2L	30	30	SIDE ROAD LEFT							1		X													
SIGN SUMMARY SHEET							SHEET TOTALS		36.25	0.00	0	2	2	6	0	0	5	75											
VERMONT AGENCY OF TRANSPORTATION							SF	SF	EA	EA	EA	EA	EA	EA	EA	EA	EA	EA	EA	EA	EA	EA	EA	EA	EA	EA	EA	EA	
							TOWN TOTALS		130.2	0.0	41.0	13.0	9.0	26	0.0	0.0	26	390.0											
PROJECT NAME: Hartford-East Montpelier VT14															PROJECT NUMBER: STPG SIGN(21)														
FILE NAME: Hartford.xls															PLOT DATE: 6/10/2009														
PROJECT MANAGER: N. Avery															DRAWN BY: I. Shea														
DESIGNED BY: D. Crosslev															CHECKED BY: S. Menard														
HARTFORD SHEET 5															SHEET 12 OF 162														

DIRECTION	MILEPOINT	LOCATION CODE (SHEET 2)	SIGN CODE	WIDTH (IN)	HEIGHT (IN)	SHEETING REMARKS	SIGN LEGEND	NEW SIGNS		EXISTING SIGNS				EXIST POST		NUMBER OF NEW POSTS	SQUARE STEEL (IN)			TUBULAR STEEL Ø (IN)				SIGN FRAME REQUIRED	REMARKS	SIGN DETAIL			
								"A"	"B"	RETAIN	SALVAGE FROM	SALVAGE TO	REMOVE	RETAIN	REMOVE		1.75	2.00	2.50	FOUNDATION	3.00	3.50	4.00			5.00	DETAIL IN SHS	DETAIL ON SHEET NUMBER	DETAIL ON STD SHEET NUMBER
																	(LB / FT)				(LB / FT)								
HARTFORD VT 14							FY-FLUORESCENT YELLOW FYG-FLUORESCENT YELLOW GREEN																"SHS"-STANDARD HIGHWAY SIGNS						
SB	7.330	F	W11-2	30	30																								
		F	W7-3A	24	18																								
		F	W11-2	30	30			6.25											X							X			
		F	W7-3A	24	18			3.00																		X			
SB	7.310	F	W2-2L	30	30		SIDE ROAD LEFT	6.25											X						X				
SB	7.216	F	R2-1	24	30		SPEED LIMIT 35 MPH			1										X									
SB	6.899	H	R1-1	30	30		STOP			1										X									
SB	6.858	F	M3-3S	24	12																								
		F	M1-5	24	24																								
		F	M3-3	24	12			2.00												X						X			
		F	M1-5	24	24			4.00																		X	E-136B		
SB	6.830	F	R2-1	24	30																								
		F	R2-1	24	30			5.00																		X			
SB	6.757	F	W1-4R	30	30		RIGHT REVERSE CURVE			1										X									
SB	6.471	F	R2-1	24	30		SPEED LIMIT 50			1											X								
SIGN SUMMARY SHEET							SHEET TOTALS	26.50	0.00	4	0	0	5	0	0	4	60								PROJECT NAME: Hartford-East Montpelier VT14				
							SF	SF	EA	EA	EA	EA	EA	EA	EA	EA	EA	FT								PROJECT NUMBER: STPG SIGN(21)			
VERMONT AGENCY OF TRANSPORTATION							TOWN TOTALS	130.2	0.0	41.0	13.0	9.0	26	0.0	0.0	26	390.0									FILE NAME: Hartford.xls			
																										PLOT DATE: 6/10/2009			
																											DRAWN BY: I. Shea		
																											DESIGNED BY: D. Crosslev		
																											CHECKED BY: S. Menard		
																											SHEET 13 OF 162		

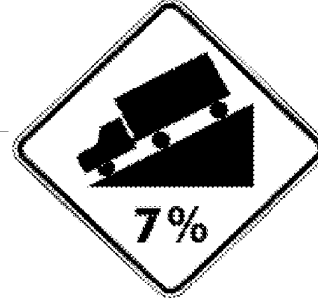
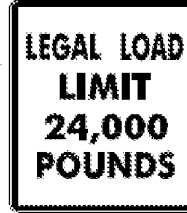
DIRECTION	MILEPOINT	LOCATION CODE (SHEET 2)	SIGN CODE	WIDTH (IN)	HEIGHT (IN)	SHEETING REMARKS	SIGN LEGEND FOR ALL POST LENGTHS AND INSTALLATION DATES SEE ORIGINAL RECORD PLANS	NEW SIGNS		EXISTING SIGNS				EXIST POST		NUMBER OF NEW POSTS	SQUARE STEEL (IN) (LB / FT)			TUBULAR STEEL Ø (IN) (LB / FT)				SIGN FRAME REQUIRED	REMARKS	SIGN DETAIL			
								"A"	"B"	RETAIN	SALVAGE FROM	SALVAGE TO	REMOVE	RETAIN	REMOVE		1.75	2.00	2.50	FOUNDATION	3.00	3.50	4.00			5.00	DETAIL IN SHS	DETAIL ON SHEET NUMBER	DETAIL ON STD SHEET NUMBER
HARTFORD VT 14							FY-FLUORESCENT YELLOW FYG-FLUORESCENT YELLOW GREEN															"SHS"-STANDARD HIGHWAY SIGNS							
SB	6.378	F	S3-1	30	30																								
		F	S3-1	30	30			6.25																			X		
SB	5.970	F	W1-2R	30	30		RIGHT CURVE				1																SALVAGED TO 5.940 SB		
SB	5.940	F	W1-2R	30	30		RIGHT CURVE	6.25				1	1														INSTALL 150' +/- SOUTH OF ORIGINAL LOCATION SALVAGED FROM 5.970 SB SHOTGUN DAMAGE		
SB	4.940	F	W1-10L	30	30		MODIFIED LEFT CURVE						0+														NO EXISTING		
		F	W16-8A	30	10								0+														NO EXISTING		
		F	W1-2MbL	30	30			6.25																			6		
		F	W16-8A	24	8			1.33																			7		
SB	4.610	F	W1-2L	30	30		LEFT CURVE	6.25		1			1														SHOTGUN DAMAGE		
		F	W13-1	24	24		40 MPH PLAQUE			1																			
SB	4.471	F	W1-6	48	24		<=== LEFT LARGE ARROW	8.00			1	1	1														SHOTGUN DAMAGE INSTALL SIGN ON NEW POSTS		
		E	W1-6	48	24		RIGHT ==> LARGE ARROW				1	1															INSTALL SIGN ON NEW POSTS		
SB	4.436	F	W1-6	48	24		<=== LEFT LARGE ARROW	8.00			1	1	1														SHOTGUN DAMAGE INSTALL SIGN ON NEW POSTS		
SB	3.992	F	W2-2L	30	30		LEFT SIDE ROAD	6.25		1																			
		F	W16-8A	30	10								1																
SIGN SUMMARY SHEET							SHEET TOTALS	48.58 43.33	0.00	3	4	4	5 4	0	0	7	105						PROJECT NAME: Hartford-East Montpelier VT14 PROJECT NUMBER: STPG SIGN(21)						
VERMONT AGENCY OF TRANSPORTATION							TOWN TOTALS	130.2	0.0	41.0	13.0	9.0	26	0.0	0.0	26	390.0						FILE NAME: Hartford.xls PROJECT MANAGER: N. Avery DESIGNED BY: D. Crosslev HARTFORD SHEET 7	PLOT DATE: 6/10/2009 DRAWN BY: I. Shea CHECKED BY: S. Menard SHEET 14 OF 162					

DIRECTION	MILEPOINT	LOCATION CODE (SHEET 2)	SIGN CODE	WIDTH (IN)	HEIGHT (IN)	SHEETING REMARKS	SIGN LEGEND FOR ALL POST LENGTHS AND INSTALLATION DATES SEE ORIGINAL RECORD PLANS	NEW SIGNS		EXISTING SIGNS				EXIST POST		NUMBER OF NEW POSTS	SQUARE STEEL (IN)			TUBULAR STEEL Ø (IN)				SIGN FRAME REQUIRED	REMARKS	SIGN DETAIL			
								"A"	"B"	RETAIN	SALVAGE FROM	SALVAGE TO	REMOVE	RETAIN	REMOVE		1.75	2.00	2.50	FOUNDATION	3.00	3.50	4.00			5.00	DETAIL IN SHS	DETAIL ON SHEET NUMBER	DETAIL ON STD SHEET NUMBER
																	(LB / FT)				(LB / FT)								
HARTFORD VT 14							FY-FLUORESCENT YELLOW FYG-FLUORESCENT YELLOW GREEN															"SHS"-STANDARD HIGHWAY SIGNS							
		F	W16-8A	24	8			1.33																7					
SB	2.144	G	VR-023B	24	30																								
		G	VR-023B	24	30			5.00						1		X									E-144				
SB	1.603	F	W3-5	36	36		SPEED REDUCTION AHEAD SPEED LIMIT 30			1																			
SB	1.533	F	VD-018	30	18			3.75						1		X									INSTALL ACROSS FROM VT 14 SIGN E-128B				
SB	1.477	F	VR-038	24	18		STATE HIGHWAY ENDS			1																			
		F	R2-1	24	30		SPEED LIMIT 30			1																			
SIGN SUMMARY SHEET								SHEET TOTALS		10.08	0.00	3	0	0	0	0	0	2	30						PROJECT NAME: Hartford-East Montpelier VT14				
								SF	SF	EA	EA	EA	EA	EA	EA	EA	EA	EA	FT						PROJECT NUMBER: STPG SIGN(21)				
								TOWN TOTALS		130.2	0.0	41.0	13.0	9.0	26	0.0	0.0	26	390.0						FILE NAME: Hartford.xls				
																									PLOT DATE: 6/10/2009				
																									DRAWN BY: I. Shea				
																									DESIGNED BY: D. Crossley				
																									CHECKED BY: S. Menard				
																									SHEET 15 OF 162				

DIRECTION	MILEPOINT	LOCATION CODE (SHEET 2)	SIGN CODE	WIDTH (IN)	HEIGHT (IN)	SHEETING REMARKS	SIGN LEGEND FOR ALL POST LENGTHS AND INSTALLATION DATES SEE ORIGINAL RECORD PLANS	NEW SIGNS		EXISTING SIGNS			EXIST POST		NUMBER OF NEW POSTS	SQUARE STEEL (IN)			TUBULAR STEEL Ø (IN)				SIGN FRAME REQUIRED	REMARKS	SIGN DETAIL				
								"A"	"B"	RETAIN	SALVAGE FROM	SALVAGE TO	REMOVE	RETAIN		REMOVE	1.75	2.00	2.50	FOUNDATION	3.00	3.50			4.00	5.00	DETAIL IN SHS	DETAIL ON SHEET NUMBER	DETAIL ON STD SHEET NUMBER
																	(LB / FT)				(LB / FT)								
SHARON VT14							FY-FLUORESCENT YELLOW FYG-FLUORESCENT YELLOW GREEN															"SHS"-STANDARD HIGHWAY SIGNS							
	NB	0.000																					(SEE SHEET 29)						
	NB	0.008	C	VR-017	24	30	LEGAL LOAD LIMIT 24,000 LBS			1													SHAREHART RD TH-43						
	NB	0.014	D	R1-1	30	30	STOP			1																			
	NB	0.600	A	VW-054	30	30	HIDDEN DRIVE RIGHT						1																
	NB	0.620	A	VW-054	30	30		6.25						1				X					INSTALL 100' +/- NORTH OF ORIGINAL SIGN LOCATION			E-154			
	NB	2.775	A	W1-4R	30	30							1																
			A	W13-1	18	18							1																
	NB	2.805	A	W1-4R	30	30		6.25						1				X					INSTALL 160' NORTH OF ORIGINAL SIGN LOCATION	X					
			A	W13-1	18	18		2.25																X					
	NB	2.864	A	S3-1	30	30	SCHOOL BUS STOP AHEAD						1																
	NB	2.906	A	W12-2	36	36							1																
			A	W12-2	30	30		6.25						1				X						X					
	NB	2.948	A	OM-3R	12	36							1																
			A	OM-3R	12	36	FY	3.00						1				X					X						
	NB	2.960	B	W1-6	48	24							1																
			B	W1-6	48	24		8.00						2				X						X					
SIGN SUMMARY SHEET							SHEET TOTALS	32.00	0.00	2	0	0	7	0	0	6	90												
							SF	SF	EA	EA	EA	EA	EA	EA	EA	EA	FT												
VERMONT AGENCY OF TRANSPORTATION							TOWN TOTALS	447.0	0.0	11.0	1.0	1.0	93	0.0	0.0	64	960.0												
																					PROJECT NAME:	Hartford-East Montpelier VT14							
																					PROJECT NUMBER:	STPG SIGN(21)							
											FILE NAME:	Sharon.xls	PLOT DATE:	6/10/2009															
											PROJECT MANAGER:	N. Avery	DRAWN BY:	T. Guazzoni															
											DESIGNED BY:	D. Crosslev	CHECKED BY:	S. Menard															
											SHARON SHEET 1	SHEET	16	OF	162														

DIRECTION	MILEPOINT	LOCATION CODE (SHEET 2)	SIGN CODE	WIDTH (IN)	HEIGHT (IN)	SHEETING REMARKS	SIGN LEGEND FOR ALL POST LENGTHS AND INSTALLATION DATES SEE ORIGINAL RECORD PLANS	NEW SIGNS		EXISTING SIGNS				EXIST POST		NUMBER OF NEW POSTS	SQUARE STEEL (IN) (LB / FT)			TUBULAR STEEL Ø (IN) (LB / FT)				SIGN FRAME REQUIRED	REMARKS	SIGN DETAIL				
								"A"	"B"	RETAIN	SALVAGE FROM	SALVAGE TO	REMOVE	RETAIN	REMOVE		1.75	2.00	2.50	FOUNDATION	3.00	3.50	4.00			5.00	DETAIL IN SHS	DETAIL ON SHEET NUMBER	DETAIL ON STD SHEET NUMBER	
																														1.88
SHARON VT14							FY-FLUORESCENT YELLOW FYG-FLUORESCENT YELLOW GREEN															"SHS"-STANDARD HIGHWAY SIGNS								
NB	3.660	A	W7-1B	30	30																									
		A	W7-1B	30	30			6.25											X					X						
NB	3.762	C	VR-017	24	30																									
		C	VR-017	24	30			5.00											X						E-141					
NB	3.768	D	R1-1	30	30		STOP			1																				
NB	4.006	A	S3-1	30	30		SCHOOL BUS STOP AHEAD																							
NB	4.250	A	R2-5A	24	30																									
		A	W3-5	36	36			9.00											X					X						
NB	4.390	A	R2-1	24	30																									
		A	R2-1	30	36			7.50											X						6					
NB	4.530	A	W11-2	30	30																									
		A	W11-2	30	30	FYG		6.25											X					X						
		A	W7-3A	18	24	FYG		3.00																X						
NB	4.600	A	R2-1	24	30																									
		A	R2-1	30	36			7.50											X						6					
SIGN SUMMARY SHEET							SHEET TOTALS	44.50	0.00	1	0	0	87	0	0	7	105													
VERMONT AGENCY OF TRANSPORTATION							TOWN TOTALS	447.0	0.0	11.0	1.0	1.0	93	0.0	0.0	64	960.0													
PROJECT NAME: Hartford-East Montpelier VT14 PROJECT NUMBER: STPG SIGN(21)																	FILE NAME: Sharon.xls PROJECT MANAGER: N. Averv DESIGNED BY: D. Crossley SHARON SHEET 2						PLOT DATE: 6/10/2009 DRAWN BY: T. Guazzoni CHECKED BY: S. Menard SHEET 17 OF 162							

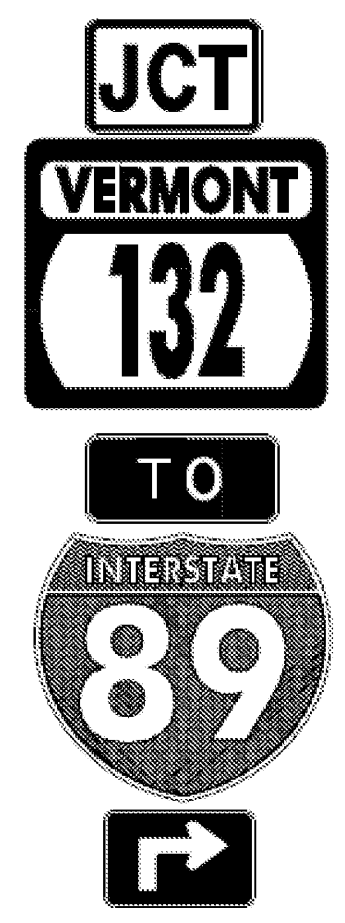
DIRECTION	MILEPOINT	LOCATION CODE (SHEET 2)	SIGN CODE	WIDTH (IN)	HEIGHT (IN)	SHEETING REMARKS	SIGN LEGEND	NEW SIGNS		EXISTING SIGNS				EXIST POST		NUMBER OF NEW POSTS	SQUARE STEEL (IN)			TUBULAR STEEL Ø (IN)				SIGN FRAME REQUIRED	REMARKS	SIGN DETAIL			
								"A"	"B"	RETAIN	SALVAGE FROM	SALVAGE TO	REMOVE	RETAIN	REMOVE		1.75	2.00	2.50	FOUNDATION	3.00	3.50	4.00			5.00	DETAIL IN SHS	DETAIL ON SHEET NUMBER	DETAIL ON STD SHEET NUMBER
																	(LB / FT)				(LB / FT)								
SHARON VT14							FY-FLUORESCENT YELLOW FYG-FLUORESCENT YELLOW GREEN															"SHS"-STANDARD HIGHWAY SIGNS							
NB	4.782	A	R2-1	24	30																								
		A	R2-1	24	30			5.00																X					
NB	4.820	A	VD-062A	72	16		BUSINESS SIGN			1																			
NB	4.910	A	M2-1S	21	15																								
		A	M1-5	30	24																								
		A	M4-5	24	12																								
		A	M1-1	24	24																								
		A	M5-1	21	15																								
		A	M2-1S	21	15			2.19															1A	GREEN ON WHITE SHEETING	X 7				
		A	M1-5	30	24			5.00																	E-136B				
		A	M4-5	24	12			2.00																WHITE ON BLUE SHEETING	X				
		A	M1-1	24	24		4.00																	X					
		A	M5-1	21	15		2.19																WHITE ON BLUE SHEETING	X					
NB	4.950	A	D1-1A	72	10																								
		A	D1-1A	72	10																								
SIGN SUMMARY SHEET							SHEET TOTALS	20.38	0.00	1	0	0	8	0	0	3	45						PROJECT NAME: Hartford-East Montpelier VT14						
							SF	SF	EA	EA	EA	EA	EA	EA	EA	FT						PROJECT NUMBER: STPG SIGN(21)							
VERMONT AGENCY OF TRANSPORTATION							TOWN TOTALS	447.0	0.0	11.0	1.0	1.0	93	0.0	0.0	64	960.0						FILE NAME: Sharon.xls						
																						PLOT DATE: 6/10/2009							
																						DRAWN BY: T. Guazzoni							
																						DESIGNED BY: D. Crosslev							
																						CHECKED BY: S. Menard							
																						SHEET 18 OF 162							





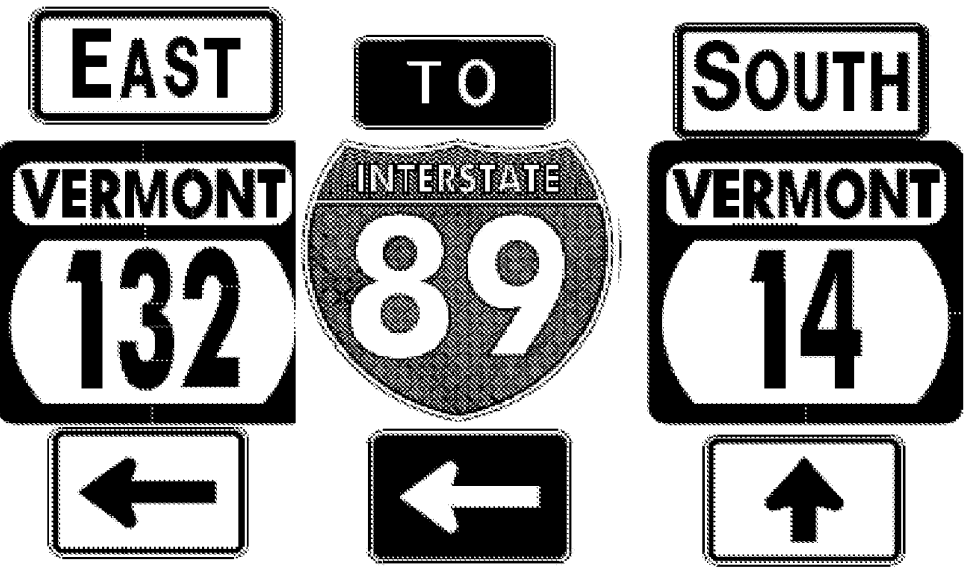

DIRECTION	MILEPOINT	LOCATION CODE (SHEET 2)	SIGN CODE	WIDTH (IN)	HEIGHT (IN)	SHEETING REMARKS	SIGN LEGEND	NEW SIGNS		EXISTING SIGNS				EXIST POST		NUMBER OF NEW POSTS	SQUARE STEEL (IN)			TUBULAR STEEL Ø (IN)				SIGN FRAME REQUIRED	REMARKS	SIGN DETAIL		
								"A"	"B"	RETAIN	SALVAGE FROM	SALVAGE TO	REMOVE	RETAIN	REMOVE		1.75	2.00	2.50	3.00	3.50	4.00	5.00			DETAIL IN SHS	DETAIL ON SHEET NUMBER	DETAIL ON STD SHEET NUMBER
																	(LB / FT)			(LB / FT)								
SHARON VT14							FY-FLUORESCENT YELLOW FYG-FLUORESCENT YELLOW GREEN															"SHS"-STANDARD HIGHWAY SIGNS						
			A	D1-1A	72	10																						
			A	D1-1A	72	12		6.00								2		X								5		
			A	D1-1A	72	12		6.00																		5		
			A	D1-1A	72	12		6.00																		5		
NB	4.990		A	M3-1S	24	12																						
			A	M1-5	24	24																						
			A	M6-3S	21	15																						
			A	M3-2S	24	12																						
			A	M1-5	30	24																						
			A	M6-1S	21	15																						
			A	M4-5	24	12																						
			A	M1-1	24	24																						
			A	M6-1	21	15																						
			A	M3-1S	24	12																						
			A	M1-5	24	24																						
SIGN SUMMARY SHEET							SHEET TOTALS		24.00	0.00	0	0	0	10	0	0	2	30										
VERMONT AGENCY OF TRANSPORTATION							SF	SF	EA	EA	EA	EA	EA	EA	EA	EA	EA	EA	FT									
TOWN TOTALS							447.0	0.0	11.0	1.0	1.0	93	0.0	0.0	64	960.0												
																	PROJECT NAME: Hartford-East Montpelier VT14											
																	PROJECT NUMBER: STPG SIGN(21)											
																	FILE NAME: Sharon.xls	PLOT DATE: 6/10/2009										
																	PROJECT MANAGER: N. Avery	DRAWN BY: T. Guazzoni										
																	DESIGNED BY: D. Crosslev	CHECKED BY: S. Menard										
																	SHARON SHEET 4	SHEET 19 OF 162										





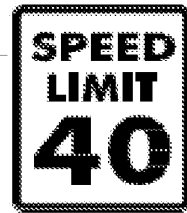

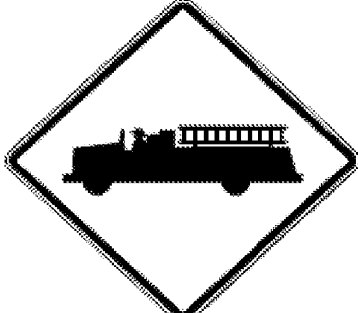
DIRECTION	MILEPOINT	LOCATION CODE (SHEET 2)	SIGN CODE	WIDTH (IN)	HEIGHT (IN)	SHEETING REMARKS	SIGN LEGEND	NEW SIGNS		EXISTING SIGNS				EXIST POST		NUMBER OF NEW POSTS	SQUARE STEEL (IN)			TUBULAR STEEL Ø (IN)				SIGN FRAME REQUIRED	REMARKS	SIGN DETAIL			
								"A"	"B"	RETAIN	SALVAGE FROM	SALVAGE TO	REMOVE	RETAIN	REMOVE		1.75	2.00	2.50	FOUNDATION	3.00	3.50	4.00			5.00	DETAIL IN SHS	DETAIL ON SHEET NUMBER	DETAIL ON STD SHEET NUMBER
																	(LB / FT)				(LB / FT)								
SHARON VT14							FY-FLUORESCENT YELLOW FYG-FLUORESCENT YELLOW GREEN															"SHS"-STANDARD HIGHWAY SIGNS							
			A	M6-3S	21	15		2.19																GREEN ON WHITE SHEETING	X				
			A	M3-2S	24	12		2.00																GREEN ON WHITE SHEETING	X				
			A	M1-5	30	24		5.00																		E-136B			
			A	M6-1S	21	15		2.19																GREEN ON WHITE SHEETING	X				
			A	M4-5	24	12		2.00																BLUE ON WHITE SHEETING	X				
			A	M1-1	24	24		4.00																		X			
			A	M6-1	21	15		2.19																BLUE ON WHITE SHEETING	X				
			B	M3-2	24	12																							
			B	M1-5	30	24																							
			B	M6-1S	21	15																							
			B	M4-5	24	12																							
			B	M1-1	24	24																							
			B	M6-1	21	15																							
			B	M3-3	24	12																							
			B	M1-5	24	24																							
SIGN SUMMARY SHEET							SHEET TOTALS	19.57	0.00	0	0	0	8	0	0	0	0	0	0	0	0	0	0	0					
							SF	SF	EA	EA	EA	EA	EA	EA	EA	EA	EA	EA	EA	EA	EA	EA	EA	EA					
VERMONT AGENCY OF TRANSPORTATION							TOWN TOTALS	447.0	0.0	11.0	1.0	1.0	93	0.0	0.0	64	960.0												
PROJECT NAME: Hartford-East Montpelier VT14																					PROJECT NUMBER: STPG SIGN(21)								
FILE NAME: Sharon.xls																		PLOT DATE: 6/10/2009											
PROJECT MANAGER: N. Avery																		DRAWN BY: T. Guazzoni											
DESIGNED BY: D. Crosslev																		CHECKED BY: S. Menard											
SHARON SHEET 5																		SHEET 20 OF 162											

DIRECTION	MILEPOINT	LOCATION CODE (SHEET 2)	SIGN CODE	WIDTH (IN)	HEIGHT (IN)	SHEETING REMARKS	SIGN LEGEND FOR ALL POST LENGTHS AND INSTALLATION DATES SEE ORIGINAL RECORD PLANS	NEW SIGNS		EXISTING SIGNS				EXIST POST		NUMBER OF NEW POSTS	SQUARE STEEL (IN) (LB / FT)			TUBULAR STEEL Ø (IN) (LB / FT)				SIGN FRAME REQUIRED	REMARKS	SIGN DETAIL				
								"A"	"B"	RETAIN	SALVAGE FROM	SALVAGE TO	REMOVE	RETAIN	REMOVE		1.75	2.00	2.50	FOUNDATION	3.00	3.50	4.00			5.00	DETAIL IN SHS	DETAIL ON SHEET NUMBER	DETAIL ON STD SHEET NUMBER	
																	1.88	2.42	3.35		7.60	9.00	10.80			14.60				
SHARON VT14							FY-FLUORESCENT YELLOW FYG-FLUORESCENT YELLOW GREEN													"SHS"-STANDARD HIGHWAY SIGNS										
			B M6-3S	21	15																									
			B M3-2	24	12														2.00			3B	GREEN ON WHITE SHEETING	X		7				
			B M1-5	30	24														5.00								E-136B			
			B M6-1	21	15														2.19				GREEN ON WHITE SHEETING	X						
			B M4-5	24	12														2.00				WHITE ON BLUE SHEETING	X						
			B M1-1	24	24														4.00						X					
			B M6-1	21	15														2.19				WHITE ON BLUE SHEETING	X						
			B M3-3	24	12														2.00				GREEN ON WHITE SHEETING	X						
			B M1-5	24	24														4.00								E-136B			
			B M6-3	21	15														2.19				GREEN ON WHITE SHEETING	X						
NB	5.050		A M3-1S	24	12																									
			A M1-5	24	24																									
			A M3-1S	24	12														2.00				GREEN ON WHITE SHEETING	X						
			A M1-5	24	24														4.00								E-136B			
NB	5.092		A R2-1	24	30																									
SIGN SUMMARY SHEET							SHEET TOTALS											1					PROJECT NAME: Hartford-East Montpelier VT14							
VERMONT AGENCY OF TRANSPORTATION							SF	SF	EA	EA	EA	EA	EA	EA	EA	EA	EA	EA	EA	EA	EA					PROJECT NUMBER: STPG SIGN(21)				
							TOWN TOTALS											64	960.0				FILE NAME: Sharon.xls PLOT DATE: 6/10/2009							
																							PROJECT MANAGER: N. Averv DRAWN BY: T. Guazzoni							
																							DESIGNED BY: D. Crossley CHECKED BY: S. Menard							
																							SHARON SHEET 6 SHEET 21 OF 162							

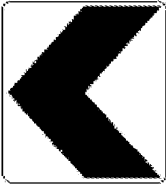
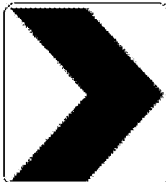



0
1
3
4

DIRECTION	MILEPOINT	LOCATION CODE (SHEET 2)	SIGN CODE	WIDTH (IN)	HEIGHT (IN)	SHEETING REMARKS	SIGN LEGEND FOR ALL POST LENGTHS AND INSTALLATION DATES SEE ORIGINAL RECORD PLANS	NEW SIGNS		EXISTING SIGNS				EXIST POST		NUMBER OF NEW POSTS	SQUARE STEEL (IN) (LB / FT)			TUBULAR STEEL Ø (IN) (LB / FT)				SIGN FRAME REQUIRED	REMARKS	SIGN DETAIL			
								"A"	"B"	RETAIN	SALVAGE FROM	SALVAGE TO	REMOVE	RETAIN	REMOVE		1.75	2.00	2.50	FOUNDATION	3.00	3.50	4.00			5.00	DETAIL IN SHS	DETAIL ON SHEET NUMBER	DETAIL ON STD SHEET NUMBER
																	1.88	2.42	3.35		7.60	9.00	10.80			14.60			
SHARON VT14							FY-FLUORESCENT YELLOW FYG-FLUORESCENT YELLOW GREEN															"SHS"-STANDARD HIGHWAY SIGNS							
		A	NA	12	18										1									REMOVE ILLEGAL SIGN					
		A	R2-1	24	30			5.00										X						X					
NB	5.322	C	VR-017	24	30		LEGAL LOAD LIMIT 24,000 LBS				1													FAY BROOK RD TH-17					
NB	5.332	D	R1-1	30	30		STOP				1																		
NB	5.370	A	D2-1	72	10										1														
		A	D2-1	72	12			6.00										X								5			
NB	5.470	A	R2-1	24	30										1														
		A	R2-1	24	30			5.00										X						X					
NB	5.670	A	R2-1	24	30										1														
		A	R2-1	24	30			5.00										X						X					
NB	5.695	A	W11-8	30	30										1														
		A	W11-8	30	30			6.25										X						X					
NB	6.000	A	R2-1	24	30										1														
		A	R2-1	24	30			5.00										X						X					
NB	6.030	A	W1-2L	30	30										1			X											
SIGN SUMMARY SHEET							SHEET TOTALS	32.25	0.00	2	0	0	7	0	0	7	105												
VERMONT AGENCY OF TRANSPORTATION							TOWN TOTALS	447.0	0.0	11.0	1.0	1.0	93	0.0	0.0	64	960.0												
PROJECT NAME: Hartford-East Montpelier VT14																			PROJECT NUMBER: STPG SIGN(21)										
FILE NAME: Sharon.xls																			PLOT DATE: 6/10/2009										
PROJECT MANAGER: N. Avery																			DRAWN BY: T. Guazzoni										
DESIGNED BY: D. Crossley																			CHECKED BY: S. Menard										
SHARON SHEET 7																			SHEET 22 OF 162										



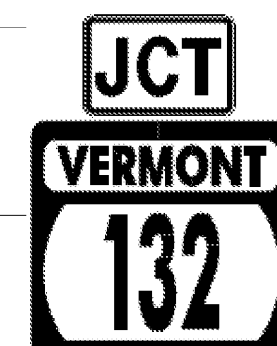

DIRECTION	MILEPOINT	LOCATION CODE (SHEET 2)	SIGN CODE	WIDTH (IN)	HEIGHT (IN)	SHEETING REMARKS	SIGN LEGEND FOR ALL POST LENGTHS AND INSTALLATION DATES SEE ORIGINAL RECORD PLANS	NEW SIGNS		EXISTING SIGNS				EXIST POST		NUMBER OF NEW POSTS	SQUARE STEEL (IN)			TUBULAR STEEL Ø (IN)				SIGN FRAME REQUIRED	REMARKS	SIGN DETAIL			
								"A"	"B"	RETAIN	SALVAGE FROM	SALVAGE TO	REMOVE	RETAIN	REMOVE		1.75	2.00	2.50	FOUNDATION	3.00	3.50	4.00			5.00	DETAIL IN SHS	DETAIL ON SHEET NUMBER	DETAIL ON STD SHEET NUMBER
																	(LB / FT)				(LB / FT)								
SHARON VT14							FY-FLUORESCENT YELLOW FYG-FLUORESCENT YELLOW GREEN															"SHS"-STANDARD HIGHWAY SIGNS							
NB	6.100	A	W1-2L	30	30			6.25							1	X								INSTALL 425'+/- NORTH OF ORIGINAL SIGN LOCATION	X				
NB	6.160	A	W1-8L	18	24			3.00							1	X								INSTALL AT APEX OF CURVE	X				
		B	W1-8R	18	24			3.00							1	X								INSTALL AT APEX OF CURVE	X				
NB	6.516	C	VR-017	24	30																			WHITE BROOK RD TH-7					
		C	VR-017	24	30			5.00							1	X											E-141		
NB	6.523	D	R1-1	30	30																								
		D	R1-1	30	30			6.25							1	X									X				
NB	6.630	A	D1-1E	72	20		THE SHARON ACADEMY --->			1																			
NB	6.773	D	R1-1	30	30																								
		D	R1-1	30	30			6.25							1	X									X				
SB	7.000	G	VR-023B	20	30			5.00							1	X											6		
SB	6.990	F	VW-202	30	30																								
		F	VW-202	30	30			6.25							1	X											E-154		
SB	6.870	F	D1-1E	72	20		<--- THE SHARON ACADEMY			1																			
SB	6.530	G	VR-278	24	36		PROHIBITED DUMPING HOUSEHOLD TRASH IN OR ABOUT CONTAINER																						
SIGN SUMMARY SHEET							SHEET TOTALS	41.00	0.00	2	0	0	4	0	0	8	120									PROJECT NAME: Hartford-East Montpelier VT14 PROJECT NUMBER: STPG SIGN(21)			
VERMONT AGENCY OF TRANSPORTATION								SF	SF	EA	EA	EA	EA	EA	EA	EA	EA	EA	EA	EA	EA	EA	EA	EA	EA		FILE NAME: Sharon.xls PROJECT MANAGER: N. Avery DESIGNED BY: D. Crossley SHARON SHEET 8		
							TOWN TOTALS	447.0	0.0	11.0	1.0	1.0	93	0.0	0.0	64	960.0									PLOT DATE: 6/10/2009 DRAWN BY: T. Guazzoni CHECKED BY: S. Menard SHEET 23 OF 162			



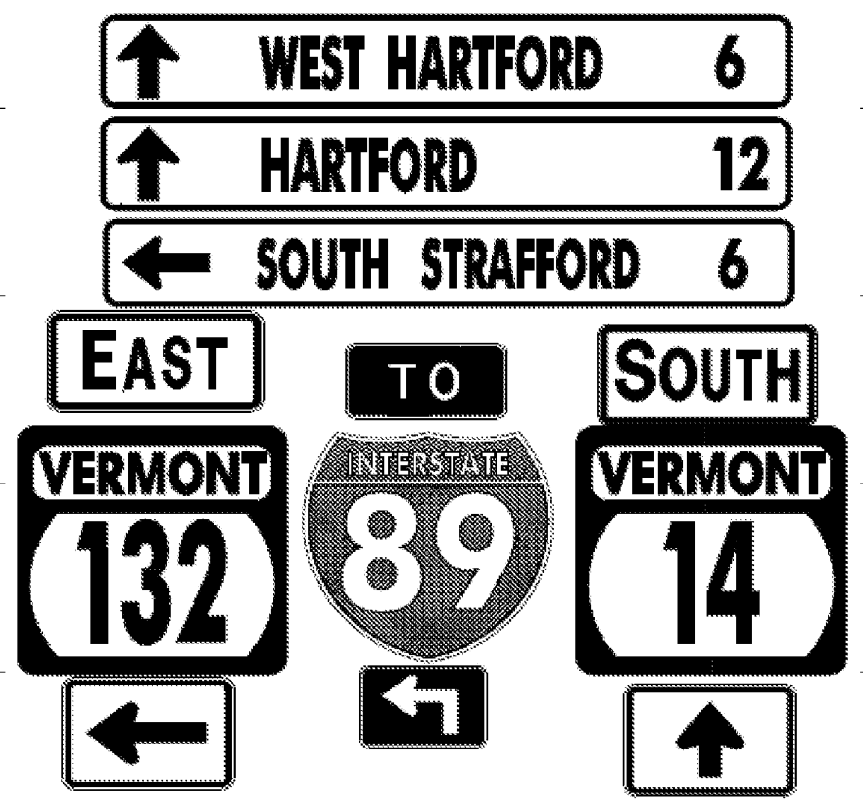



DIRECTION	MILEPOINT	LOCATION CODE (SHEET 2)	SIGN CODE	WIDTH (IN)	HEIGHT (IN)	SHEETING REMARKS	SIGN LEGEND	NEW SIGNS		EXISTING SIGNS				EXIST POST		NUMBER OF NEW POSTS	SQUARE STEEL (IN)			TUBULAR STEEL Ø (IN)				SIGN FRAME REQUIRED	REMARKS	SIGN DETAIL			
								"A"	"B"	RETAIN	SALVAGE FROM	SALVAGE TO	REMOVE	RETAIN	REMOVE		1.75	2.00	2.50	3.00	3.50	4.00	5.00			DETAIL IN SHS	DETAIL ON SHEET NUMBER	DETAIL ON STD SHEET NUMBER	
																	(LB / FT)			(LB / FT)									
SHARON VT14							FY-FLUORESCENT YELLOW FYG-FLUORESCENT YELLOW GREEN															"SHS"-STANDARD HIGHWAY SIGNS							
			G	VR-023B	24	30		5.00								1	X											6	
SB	6.350		F	W1-4L	30	30	LEFT REVERSE CURVE									1	X												
SB	6.120		F	R2-5A	24	30	REDUCED SPEED AHEAD																						
			F	W3-5	36	36		9.00								2	X									X			
SB	6.000		F	R2-1	24	30																							
			F	R2-1	30	36		7.50								1												6	
SB	5.670		F	R2-1	24	30																							
			F	R2-1	24	30		5.00								1	X									X			
SB	5.520		F	VD-018	30	18																							
			F	VD-018	30	18		3.75								1	X											E-128B	
SB	5.490		F	W11-2	30	30																							
			F	W11-2	30	30	FYG	6.25								1	X									X			
			F	W7-3A	18	24	FYG	3.00																		X			
SB	5.450		F	R2-1	24	30																							
			F	R2-1	30	36		7.50								1	X											6	
SIGN SUMMARY SHEET							SHEET TOTALS	47.00	0.00	0	0	0	7	0	0	8	120												
VERMONT AGENCY OF TRANSPORTATION								SF	SF	EA	EA	EA	EA	EA	EA	EA	EA	FT											
TOWN TOTALS								447.0	0.0	11.0	1.0	1.0	93	0.0	0.0	64	960.0												
															PROJECT NAME: Hartford-East Montpelier VT14														
															PROJECT NUMBER: STPG SIGN(21)														
															FILE NAME: Sharon.xls					PLOT DATE: 6/10/2009									
															PROJECT MANAGER: N. Avery					DRAWN BY: T. Guazzoni									
															DESIGNED BY: D. Crosslev					CHECKED BY: S. Menard									
															SHARON SHEET 9					SHEET 24 OF 162									





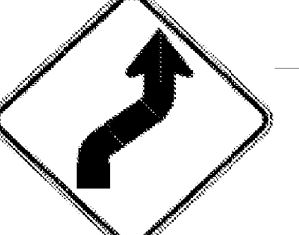

DIRECTION	MILEPOINT	LOCATION CODE (SHEET 2)	SIGN CODE	WIDTH (IN)	HEIGHT (IN)	SHEETING REMARKS	SIGN LEGEND	NEW SIGNS		EXISTING SIGNS				EXIST POST		NUMBER OF NEW POSTS	SQUARE STEEL (IN)			TUBULAR STEEL Ø (IN)				SIGN FRAME REQUIRED	REMARKS	SIGN DETAIL			
								"A"	"B"	RETAIN	SALVAGE FROM	SALVAGE TO	REMOVE	RETAIN	REMOVE		1.75	2.00	2.50	FOUNDATION	3.00	3.50	4.00			5.00	DETAIL IN SHS	DETAIL ON SHEET NUMBER	DETAIL ON STD SHEET NUMBER
																	(LB / FT)				(LB / FT)								
SHARON VT14							FY-FLUORESCENT YELLOW FYG-FLUORESCENT YELLOW GREEN															"SHS"-STANDARD HIGHWAY SIGNS							
SB	5.355	G	UNK	24	30		BRIDGE WEIGHT LIMIT 60,000 POUNDS			1					X														
SB	5.349	H	R1-1	30	30		STOP			1					X														
SB	5.279	F	VD-062A	72	16		BUSINESS SIGN			1					X														
SB	5.260	F	R2-1	24	30																								
		F	R2-1	24	30			5.00																			X		
SB	5.130	F	M2-1	21	15																								
		F	M1-5	24	30																								
		F	M2-1	21	15			2.19																				X	
		F	M1-5	24	30			5.00																					E-136B
SB	5.097	F	D1-1A	72	10																								
		F	D1-1A	72	10																								
		F	D1-1A	72	10																								
		F	M3-2S	24	12																								
		F	M1-5	30	24																								
		F	M6-1S	21	15																								
SIGN SUMMARY SHEET							SHEET TOTALS		12.19	0.00	3	0	0	9	0	0	2	30						PROJECT NAME: Hartford-East Montpelier VT14					
VERMONT AGENCY OF TRANSPORTATION							SF	SF	EA	EA	EA	EA	EA	EA	EA	EA	EA	FT						PROJECT NUMBER: STPG SIGN(21)					
TOWN TOTALS							447.0	0.0	11.0	1.0	1.0	93	0.0	0.0	64	960.0								FILE NAME: Sharon.xls	PLOT DATE: 6/10/2009				
																						PROJECT MANAGER: N. Avery	DRAWN BY: T. Guazzoni						
																						DESIGNED BY: D. Crosslev	CHECKED BY: S. Menard						
																						SHARON SHEET 10	SHEET 25 OF 162						

DIRECTION	MILEPOINT	LOCATION CODE (SHEET 2)	SIGN CODE	WIDTH (IN)	HEIGHT (IN)	SHEETING REMARKS	SIGN LEGEND FOR ALL POST LENGTHS AND INSTALLATION DATES SEE ORIGINAL RECORD PLANS	NEW SIGNS		EXISTING SIGNS				EXIST POST		NUMBER OF NEW POSTS	SQUARE STEEL (IN)			TUBULAR STEEL Ø (IN)				SIGN FRAME REQUIRED	REMARKS	SIGN DETAIL			
								"A"	"B"	RETAIN	SALVAGE FROM	SALVAGE TO	REMOVE	RETAIN	REMOVE		1.75	2.00	2.50	FOUNDATION	3.00	3.50	4.00			5.00	DETAIL IN SHS	DETAIL ON SHEET NUMBER	DETAIL ON STD SHEET NUMBER
																	(LB / FT)				(LB / FT)								
SHARON VT14							FY-FLUORESCENT YELLOW FYG-FLUORESCENT YELLOW GREEN															"SHS"-STANDARD HIGHWAY SIGNS							
			F	M4-5	24	12																							
			F	M1-1	24	24																							
			F	M5-1	21	15																							
			F	M3-3S	24	12																							
			F	M1-5	24	24																							
			F	M6-3S	21	15																							
			F	D1-1A	72	12																				5			
			F	D1-1A	72	12																				5			
			F	D1-1A	72	12																				5			
			F	M3-2S	24	12																3A	GREEN ON WHITE SHEETING	X		7			
			F	M1-5	30	24																				E-136B			
			F	M6-1S	21	15																	GREEN ON WHITE SHEETING	X					
			F	M4-5	24	12																	WHITE ON BLUE SHEETING	X					
			F	M1-1	24	24																			X				
			F	M5-1	21	15																		PLAN ERROR					
																									X				
SIGN SUMMARY SHEET							SHEET TOTALS	37.57 35.38	0.00	0	0	0	7 6	0	0	0	0	0	0	0	0	0	0						
VERMONT AGENCY OF TRANSPORTATION							TOWN TOTALS	447.0	0.0	11.0	1.0	1.0	93	0.0	0.0	64	960.0												
PROJECT NAME: Hartford-East Montpelier VT14																							PROJECT NUMBER: STPG SIGN(21)						
FILE NAME: Sharon.xls															PLOT DATE: 6/10/2009			DRAWN BY: T. Guazzoni											
PROJECT MANAGER: N. Avery															DESIGNED BY: D. Crossley			CHECKED BY: S. Menard											
SHARON SHEET 11																							SHEET 26 OF 162						











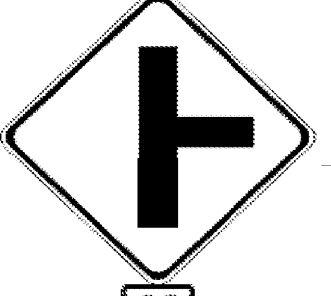

DIRECTION	MILEPOINT	LOCATION CODE (SHEET 2)	SIGN CODE	WIDTH (IN)	HEIGHT (IN)	SHEETING REMARKS	SIGN LEGEND	NEW SIGNS		EXISTING SIGNS				EXIST POST		NUMBER OF NEW POSTS	SQUARE STEEL (IN)			TUBULAR STEEL Ø (IN)				SIGN FRAME REQUIRED	REMARKS	SIGN DETAIL			
								"A"	"B"	RETAIN	SALVAGE FROM	SALVAGE TO	REMOVE	RETAIN	REMOVE		1.75	2.00	2.50	FOUNDATION	3.00	3.50	4.00			5.00	DETAIL IN SHS	DETAIL ON SHEET NUMBER	DETAIL ON STD SHEET NUMBER
																	(LB / FT)				(LB / FT)								
SHARON VT14							FY-FLUORESCENT YELLOW FYG-FLUORESCENT YELLOW GREEN															"SHS"-STANDARD HIGHWAY SIGNS							
			F M3-3S	24	12			2.00															GREEN ON WHITE SHEETING	X					
			F M1-5	24	24			4.00																	E-136B				
			F M6-3S	21	15			2.19															GREEN ON WHITE SHEETING	X					
SB	4.960		F M3-3S	24	12							1		X															
			F M1-5	24	24								1													E-136B			
			F M3-3S	24	12				2.00					1		X								GREEN ON WHITE SHEETING	X				
			F M1-5	24	24				4.00																	E-136B			
SB	4.930		F R2-1	24	30																								
			F R2-1	24	30				5.00					1		X									X				
SB	4.910		F D2-1	72	10																								
			F D2-1	72	12				6.00					2		X									5				
SB	4.800		F VW-054R	30	30																								
			F VW-054R	30	30				6.25					1		X									E-154				
SB	4.610		F R2-1	24	30																								
			F R2-1	24	30				5.00					1		X								X					
SIGN SUMMARY SHEET							SHEET TOTALS	36.44	0.00	0	0	0	6	0	0	6			90					PROJECT NAME: Hartford-East Montpelier VT14					
							SF SF	SF SF	EA EA	EA EA	EA EA	EA EA	EA EA	EA EA	EA EA	EA EA	EA EA			FT				PROJECT NUMBER: STPG SIGN(21)					
VERMONT AGENCY OF TRANSPORTATION							TOWN TOTALS	447.0	0.0	11.0	1.0	1.0	93	0.0	0.0	64			960.0					FILE NAME: Sharon.xls					
																							PLOT DATE: 6/10/2009						
																							DESIGNED BY: D. Crosslev						
																							CHECKED BY: S. Menard						
																							SHEET 27 OF 162						



DIRECTION	MILEPOINT	LOCATION CODE (SHEET 2)	SIGN CODE	WIDTH (IN)	HEIGHT (IN)	SHEETING REMARKS	SIGN LEGEND FOR ALL POST LENGTHS AND INSTALLATION DATES SEE ORIGINAL RECORD PLANS	NEW SIGNS		EXISTING SIGNS				EXIST POST		NUMBER OF NEW POSTS	SQUARE STEEL (IN) (LB / FT)			TUBULAR STEEL Ø (IN) (LB / FT)				SIGN FRAME REQUIRED	REMARKS	SIGN DETAIL			
								"A"	"B"	RETAIN	SALVAGE FROM	SALVAGE TO	REMOVE	RETAIN	REMOVE		1.75	2.00	2.50	FOUNDATION	3.00	3.50	4.00			5.00	DETAIL IN SHS	DETAIL ON SHEET NUMBER	DETAIL ON STD SHEET NUMBER
SHARON VT14							FY-FLUORESCENT YELLOW FYG-FLUORESCENT YELLOW GREEN															"SHS"-STANDARD HIGHWAY SIGNS							
SB	4.390	F	R2-1	24	30		SPEED LIMIT 50	5.00		1	1	1		X	1		X								PLAN ERROR				
SB	3.649	F	VW-059	30	30		HIDDEN DRIVE																						
SB	3.610	F	W7-1	30	30																								
		F	W7-1	30	30			6.25							2		X									X			
		F	VW-054R	30	30			6.25																				E-154	
SB	3.138	F	W1-4R	30	30																								
		F	W13-1	18	18																								
		F	W1-4R	30	30			6.25							1		X									X			
		F	W13-1	18	18			2.25																		X			
SB	3.050	F	VW-054R	30	30		HIDDEN DRIVE RIGHT																						
SB	3.004	F	S3-1	30	30																								
		F	S3-1	30	30			6.25							2		X									X			
		F	VW-054R	30	30			6.25																				E-154	
SB	2.977	F	W12-2	36	36																								
		F	W12-2	30	30			6.25							1		X									X			
SIGN SUMMARY SHEET							SHEET TOTALS	44.75 39.75	0.00	0	1	1	8 7	0	0	7	105												
VERMONT AGENCY OF TRANSPORTATION							TOWN TOTALS	447.0	0.0	11.0	1.0	1.0	93	0.0	0.0	64	960.0												
							PROJECT NAME:	Hartford-East Montpelier VT14																					
							PROJECT NUMBER:	STPG SIGN(21)																					
							FILE NAME:	Sharon.xls											PLOT DATE:	6/10/2009									
							PROJECT MANAGER:	N. Avery											DRAWN BY:	T. Guazzoni									
							DESIGNED BY:	D. Crossley											CHECKED BY:	S. Menard									
							SHARON SHEET	13											SHEET	28 OF 162									

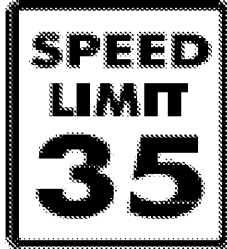

DIRECTION	MILEPOINT	LOCATION CODE (SHEET 2)	SIGN CODE	WIDTH (IN)	HEIGHT (IN)	SHEETING REMARKS	SIGN LEGEND	NEW SIGNS		EXISTING SIGNS				EXIST POST		NUMBER OF NEW POSTS	SQUARE STEEL (IN)			TUBULAR STEEL Ø (IN)				SIGN FRAME REQUIRED	REMARKS	SIGN DETAIL					
								"A"	"B"	RETAIN	SALVAGE FROM	SALVAGE TO	REMOVE	RETAIN	REMOVE		1.75	2.00	2.50	FOUNDATION	3.00	3.50	4.00			5.00	DETAIL IN SHS	DETAIL ON SHEET NUMBER	DETAIL ON STD SHEET NUMBER		
																	(LB / FT)				(LB / FT)										
SHARON VT14							FY-FLUORESCENT YELLOW FYG-FLUORESCENT YELLOW GREEN															"SHS"-STANDARD HIGHWAY SIGNS									
SB	2.970	F	OM-3R	12	36			3.00										X							INSTALL ON POST IN FRONT OF ABUTMENT	X					
SB	2.960	E	W1-6	48	24							1																			
		E	W1-6	48	24			8.00										X										X			
SB	1.575	G	VR-023B	24	30			5.00										X							INSTALL IN CENTER OF PULL OFF			6			
SB	0.640	G	VR-023B	24	30			5.00										X							INSTALL IN CENTER OF PULL OFF			6			
SB	0.540	G	VR-023B	24	30			5.00										X							INSTALL IN CENTER OF PULL OFF			6			
SB	0.440	G	VR-023B	24	30			5.00										X							INSTALL IN CENTER OF PULL OFF			6			
SB	0.120	F	S3-1	30	30		SCHOOL BUS STOP AHEAD					1																			
SB	0.000						TOWN LINE SIGN & 2 MM PLAQUES					3																			
NB	0.000			72	10		TOWN LINE	5.00																							
				6	10		MM PLAQUE	0.42																							
				6	10		MM PLAQUE	0.42																							
SIGN SUMMARY SHEET							SHEET TOTALS	36.84 31.00	0.00	0	0	0	6 2	0	0	7	105									PROJECT NAME: Hartford-East Montpelier VT14 PROJECT NUMBER: STPG SIGN(21)					
VERMONT AGENCY OF TRANSPORTATION							TOWN TOTALS	447.0	0.0	11.0	1.0	1.0	93	0.0	0.0	64	960.0									FILE NAME: Sharon.xls PROJECT MANAGER: N. Avery DESIGNED BY: D. Crossley SHARON SHEET 14					PLOT DATE: 6/10/2009 DRAWN BY: T. Guazzoni CHECKED BY: S. Menard SHEET 29 OF 162

DIRECTION	MILEPOINT	LOCATION CODE (SHEET 2)	SIGN CODE	WIDTH (IN)	HEIGHT (IN)	SHEETING REMARKS	SIGN LEGEND FOR ALL POST LENGTHS AND INSTALLATION DATES SEE ORIGINAL RECORD PLANS	NEW SIGNS		EXISTING SIGNS				EXIST POST		NUMBER OF NEW POSTS	SQUARE STEEL (IN)			TUBULAR STEEL Ø (IN)				SIGN FRAME REQUIRED	REMARKS	SIGN DETAIL			
								"A"	"B"	RETAIN	SALVAGE FROM	SALVAGE TO	REMOVE	RETAIN	REMOVE		1.75	2.00	2.50	FOUNDATION	3.00	3.50	4.00			5.00	DETAIL IN SHS	DETAIL ON SHEET NUMBER	DETAIL ON STD SHEET NUMBER
																	(LB / FT)				(LB / FT)								
ROYALTON VT 14							FY-FLUORESCENT YELLOW FYG-FLUORESCENT YELLOW GREEN															"SHS"-STANDARD HIGHWAY SIGNS							
NB	0.000	C	VD-024	60	7.5			0.84															2 MM PLAQUES @ 0.42 SF EA.						
		C	VD-024	72	10			5.00																		4			
NB	0.600	A	S3-1	30	30			6.25															PAINTBALL DAMAGE						
		A	S3-1	30	30			6.25																	X				
NB	0.760	A	W1-2L	30	30																		INSTALL 150' +/- NORTH OF ORIGINAL LOCATION						
		A	W1-2L	30	30			6.25																	X				
NB	0.900	A	R2-5A	24	30																								
		A	W3-5	36	36			9.00																	X				
NB	1.130	A	R2-1	24	30																								
		A	R2-1	30	36			7.50																			6		
NB	1.137	A	VD-062B	72	16		BUSINESS SIGN			1																			
NB	1.200	A	W2-2R	30	30		SIDE ROAD RIGHT																						
		A	W13-1	18	18		40 MPH PLAQUE																						
NB	1.260	A	VW-060	30	30		HIDDEN DRIVES																						
SIGN SUMMARY SHEET							SHEET TOTALS	41.09 34.00	0.00	1	0	0	7	0	0	7	105						PROJECT NAME: East Montpelier-Hartford VT14						
VERMONT AGENCY OF TRANSPORTATION							TOWN TOTALS	973.5	0.0	62.0	9.0	9.0	190	0.0	0.0	152	2280.0						PROJECT NUMBER: STPG SIGN(21)						
								SF	SF	EA	EA	EA	EA	EA	EA	EA	FT						FILE NAME: Royalton.xls	PLOT DATE: 6/10/2009					
																							PROJECT MANAGER: N. Avery	DRAWN BY: T. Guazzoni					
																							DESIGNED BY: D. Crossley	CHECKED BY: S. Menard					
																							ROYALTON SHEET 1	SHEET 30 OF 162					







DIRECTION	MILEPOINT	LOCATION CODE (SHEET 2)	SIGN CODE	WIDTH (IN)	HEIGHT (IN)	SHEETING REMARKS	SIGN LEGEND FOR ALL POST LENGTHS AND INSTALLATION DATES SEE ORIGINAL RECORD PLANS	NEW SIGNS		EXISTING SIGNS				EXIST POST		NUMBER OF NEW POSTS	SQUARE STEEL (IN)			TUBULAR STEEL Ø (IN)				SIGN FRAME REQUIRED	REMARKS	SIGN DETAIL			
								"A"	"B"	RETAIN	SALVAGE FROM	SALVAGE TO	REMOVE	RETAIN	REMOVE		1.75	2.00	2.50	FOUNDATION	3.00	3.50	4.00			5.00	DETAIL IN SHS	DETAIL ON SHEET NUMBER	DETAIL ON STD SHEET NUMBER
																	(LB / FT)				(LB / FT)								
ROYALTON VT 14							FY-FLUORESCENT YELLOW FYG-FLUORESCENT YELLOW GREEN															"SHS"-STANDARD HIGHWAY SIGNS							
			A W2-2R	30	30			6.25							1		X								X				
			A W13-1	18	18			2.25																	X				
NB	1.290		A VW-060	30	30			6.25							1		X										E-154		
NB	1.335		C VR-017	24	30		LEGAL LOAD LIMIT 24,000 LBS			1																	DAIRY HILL RD TH-3		
NB	1.341		D R1-1	30	30									1			X												
			D R1-1	30	30			6.25							1		X								X				
NB	1.380		A R2-1	24	30									1			X												
			A R2-1	24	30			5.00							1		X								X				
NB	1.520		A R2-1	24	30									1			X												
			A R2-1	24	30			5.00							1		X								X				
NB	1.940		A VD-062B	72	16		BUSINESS SIGN			1							X												
NB	1.961		A W3-5	36	36		SPEED REDUCTION SPEED LIMIT 35	9.00		1		1					X										SHOTGUN DAMAGE		
NB	1.980		A VD-062B	72	16		BUSINESS SIGN			1							X												
			A VD-062AL	72	16		BUSINESS SIGN			1							X												
NB	2.048		A R2-1	24	30									1			X												
SIGN SUMMARY SHEET							SHEET TOTALS	40.00 31.00	0.00	5	0	0	5	0	0	5	75												
VERMONT AGENCY OF TRANSPORTATION							TOWN TOTALS	973.5	0.0	62.0	9.0	9.0	190	0.0	0.0	152	2280.0												
																											PROJECT NAME: East Montpelier-Hartford VT14 PROJECT NUMBER: STPG SIGN(21)		
																											FILE NAME: Royalton.xls PROJECT MANAGER: N. Avery DESIGNED BY: D. Crossley ROYALTON SHEET 2		
																											PLOT DATE: 6/10/2009 DRAWN BY: T. Guazzoni CHECKED BY: S. Menard SHEET 31 OF 162		







DIRECTION	MILEPOINT	LOCATION CODE (SHEET 2)	SIGN CODE	WIDTH (IN)	HEIGHT (IN)	SHEETING REMARKS	SIGN LEGEND	NEW SIGNS		EXISTING SIGNS				EXIST POST		NUMBER OF NEW POSTS	SQUARE STEEL (IN)			TUBULAR STEEL Ø (IN)				SIGN FRAME REQUIRED	REMARKS	SIGN DETAIL		
								"A"	"B"	RETAIN	SALVAGE FROM	SALVAGE TO	REMOVE	RETAIN	REMOVE		1.75	2.00	2.50	3.00	3.50	4.00	5.00			DETAIL IN SHS	DETAIL ON SHEET NUMBER	DETAIL ON STD SHEET NUMBER
																	(LB / FT)			(LB / FT)								
ROYALTON VT 14							FY-FLUORESCENT YELLOW FYG-FLUORESCENT YELLOW GREEN															"SHS"-STANDARD HIGHWAY SIGNS						
			A R2-1	30	36			7.50							1		X								6			
NB	2.100		A W11-2YG	30	30		PEDESTRIAN			1																		
			A W16-9YG	24	10		AHEAD			1																		
NB	2.213		A M2-1S	21	15		JCT			1																		
			A M1-5	30	24		VT 110			1																		
NB	2.160		A VD-018	30	18			3.75							1		X								E-128B			
NB	2.244		A D1-1A	72	12		BETHEL 7					1																
			A D1-1A	72	12			6.00																	5			
			A D1-1	72	12		<== SOUTH ROYALTON			1																		
			A D1-1A	72	12		TUNBRIDGE 6 ==>			1																		
NB	2.273		A D4-2	30	36		PARK & RIDE CAR SYMBOL			1																		
NB	2.289		A M3-1S	24	12		NORTH			1																		
			A M1-5	24	24		VERMONT 14			1																		
			A M6-3S	21	15		^ UP ARROW			1																		
			A M3-1S	24	12		NORTH			1																		
SIGN SUMMARY SHEET							SHEET TOTALS	17.25	0.00	11	0	0	1	0	0	2	30						PROJECT NAME: East Montpelier-Hartford VT14					
							SF	SF	EA	EA	EA	EA	EA	EA	EA	EA	FT						PROJECT NUMBER: STPG SIGN(21)					
VERMONT AGENCY OF TRANSPORTATION							TOWN TOTALS	973.5	0.0	62.0	9.0	9.0	190	0.0	0.0	152	2280.0						FILE NAME: Royalton.xls					
																							PLOT DATE: 6/10/2009					
																								DRAWN BY: T. Guazzoni				
																								DESIGNED BY: D. Crosslev				
																								CHECKED BY: S. Menard				
																								ROYALTON SHEET 3				
																								SHEET 32 OF 162				



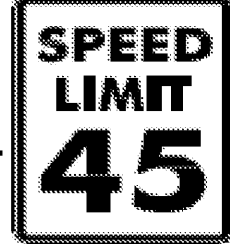

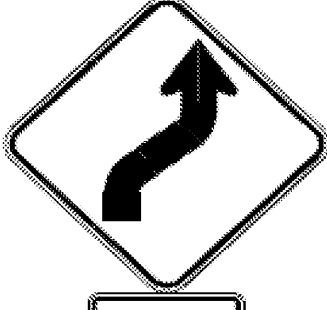









DIRECTION	MILEPOINT	LOCATION CODE (SHEET 2)	SIGN CODE	WIDTH (IN)	HEIGHT (IN)	SHEETING REMARKS	SIGN LEGEND FOR ALL POST LENGTHS AND INSTALLATION DATES SEE ORIGINAL RECORD PLANS	NEW SIGNS		EXISTING SIGNS				EXIST POST		NUMBER OF NEW POSTS	SQUARE STEEL (IN)			TUBULAR STEEL Ø (IN)				SIGN FRAME REQUIRED	REMARKS	SIGN DETAIL		
								"A"	"B"	RETAIN	SALVAGE FROM	SALVAGE TO	REMOVE	RETAIN	REMOVE		1.75	2.00	2.50	3.00	3.50	4.00	5.00			DETAIL IN SHS	DETAIL ON SHEET NUMBER	DETAIL ON STD SHEET NUMBER
																	(LB / FT)			(LB / FT)								
										1.88	2.42	3.35	FOUNDATION	7.60	9.00	10.80	14.60											
ROYALTON VT 14							FY-FLUORESCENT YELLOW FYG-FLUORESCENT YELLOW GREEN													"SHS"-STANDARD HIGHWAY SIGNS								
			A M1-5	30	24		VERMONT 110			1																		
			A M6-1S	21	15		RIGHT ---->			1																		
NB	2.345		A W11-2YG	30	30		PEDESTRIAN			1				X														
			A W16-7YG	30	30		DIAGONAL ARROW			1																		
NB	2.351		A M3-1S	24	12		NORTH				1				X												SALVAGE TO 2.360 NB	
			A M1-5	24	24		VERMONT 14				1																SALVAGE TO 2.360 NB	
NB	2.360		A M3-1S	24	12		NORTH					1				X											INSTALL SIGNS 50' +/- NORTH OF ORIGINAL LOCATION SALVAGED FROM 2.351 NB	
			A M1-5	24	24		VERMONT 14					1															INSTALL SIGNS 50' +/- NORTH OF ORIGINAL LOCATION SALVAGED FROM 2.351 NB	
NB	2.410		A R2-1	24	30									1		X												
			A R2-1	24	30			5.00									1		X								X	
NB	2.477		A D2-1	72	10			6.00																				
			A D2-1	72	12			6.00																				REDO PAINTBALL DAMAGE
NB	2.590		A R2-1	24	30		SPEED LIMIT 50			1					X													
NB	2.733		A W1-10L	30	30		MODIFIED LEFT CURVE	6.25		1			1		X													REDO SHOTGUN DAMAGE
NB	2.800	C	VR-017	24	30		LEGAL LOAD LIMIT 24,000 LBS					0 +	1	1			X											HAPPY HOLLOW RD TH-7
SIGN SUMMARY SHEET							SHEET TOTALS	23.25 11.00	0.00	6 7	3 2	3 2	4 2	0	0		5 2	30										PROJECT NAME: East Montpelier-Hartford VT14
VERMONT AGENCY OF TRANSPORTATION							TOWN TOTALS	973.5	0.0	62.0	9.0	9.0	190	0.0	0.0	152	2280.0										PROJECT NUMBER: STPG SIGN(21)	
								SF	SF	EA	EA	EA	EA	EA	EA	EA	EA	FT										FILE NAME: Royalton.xls
																												PLOT DATE: 6/10/2009
																												DRAWN BY: T. Guazzoni
																												CHECKED BY: S. Menard
																												SHEET 33 OF 162





DIRECTION	MILEPOINT	LOCATION CODE (SHEET 2)	SIGN CODE	WIDTH (IN)	HEIGHT (IN)	SHEETING REMARKS	SIGN LEGEND FOR ALL POST LENGTHS AND INSTALLATION DATES SEE ORIGINAL RECORD PLANS	NEW SIGNS		EXISTING SIGNS				EXIST POST		NUMBER OF NEW POSTS	SQUARE STEEL (IN)			TUBULAR STEEL Ø (IN)				SIGN FRAME REQUIRED	REMARKS	SIGN DETAIL			
								"A"	"B"	RETAIN	SALVAGE FROM	SALVAGE TO	REMOVE	RETAIN	REMOVE		1.75	2.00	2.50	FOUNDATION	3.00	3.50	4.00			5.00	DETAIL IN SHS	DETAIL ON SHEET NUMBER	DETAIL ON STD SHEET NUMBER
																	(LB / FT)				(LB / FT)								
ROYALTON VT 14							FY-FLUORESCENT YELLOW FYG-FLUORESCENT YELLOW GREEN															"SHS"-STANDARD HIGHWAY SIGNS							
NB	2.804	D	R1-1	30	30			6.25							1		X							X					
NB	2.850	A	W12-2	36	36		12' - 1" CLEARANCE UP/DOWN ARROWS			1																			
		A	VW-730	36	24		2 MILES AHEAD			1																			
NB	2.980	A	W1-4R	30	30		RIGHT REVERSE CURVE	6.25		1																REDO SHOTGUN DAMAGE			
		A	W13-1	24	24		35 MPH PLAQUE			1																			
NB	3.178	A	W1-6	48	24		<---- LEFT LARGE ARROW				1	1			X	2		X								REPLACE BENT POST			
		B	W1-6	48	24		RIGHT ---> LARGE ARROW				1	1			X														
NB	3.322	A	W1-2L	30	30		LEFT CURVE			1					X														
		A	W13-1	24	24		35 MPH PLAQUE			1																			
NB	3.406	A	W1-6	48	24		<--- LEFT LARGE ARROW			1					X														
NB	3.409	B	W1-6	48	24		RIGHT ---> LARGE ARROW			1					X														
NB	3.620	A	VD-062B	72	16		STANDING STONE <=== (45 DEG) PERENNIAL FARM 6/10			1					X														
NB	3.645	A	W1-3L	30	30		LEFT REVERSE TURN								X														
		A	W13-1	18	18		25 MPH PLAQUE																						
		A	W3-5	36	36			9.00								2		X								X			
SIGN SUMMARY SHEET							SHEET TOTALS	21.50 15.25	0.00	9	2	2	3 2	0	0	5		75											
VERMONT AGENCY OF TRANSPORTATION							TOWN TOTALS	973.5	0.0	62.0	9.0	9.0	190	0.0	0.0	152		2280.0											
PROJECT NAME: East Montpelier-Hartford VT14																					PROJECT NUMBER: STPG SIGN(21)								
FILE NAME: Royalton.xls												PLOT DATE: 6/10/2009																	
PROJECT MANAGER: N. Avery												DRAWN BY: T. Guazzoni																	
DESIGNED BY: D. Crossley												CHECKED BY: S. Menard																	
ROYALTON SHEET 5												SHEET 34 OF 162																	







DIRECTION	MILEPOINT	LOCATION CODE (SHEET 2)	SIGN CODE	WIDTH (IN)	HEIGHT (IN)	SHEETING REMARKS	SIGN LEGEND	NEW SIGNS		EXISTING SIGNS				EXIST POST		NUMBER OF NEW POSTS	SQUARE STEEL (IN)			TUBULAR STEEL Ø (IN)				SIGN FRAME REQUIRED	REMARKS	SIGN DETAIL			
								"A"	"B"	RETAIN	SALVAGE FROM	SALVAGE TO	REMOVE	RETAIN	REMOVE		1.75	2.00	2.50	FOUNDATION	3.00	3.50	4.00			5.00	DETAIL IN SHS	DETAIL ON SHEET NUMBER	DETAIL ON STD SHEET NUMBER
																	(LB / FT)				(LB / FT)								
ROYALTON VT 14							FY-FLUORESCENT YELLOW FYG-FLUORESCENT YELLOW GREEN															"SHS"-STANDARD HIGHWAY SIGNS							
NB	3.680	A	VD-018	30	18																								
		A	VD-018	30	18			3.75																		E-128B			
NB	3.713	A	R2-5A	24	30		REDUCED SPEED AHEAD																						
		A	W1-3L	36	36	FY		9.00																		X			
		A	W13-1	24	24	FY		4.00																		X			
NB	3.756	A	VW-268	30	30																								
		A	VW-268	30	30			6.25																		6			
NB	3.810	A	W1-6	48	24																								
		A	W1-6	48	24			8.00																		X			
NB	3.825	A	OM-3R	12	36																								
		A	OM-3R	12	36	FY		3.00																		X			
NB	3.835	B	OM-3L	12	36																								
		B	OM-3L	12	36	FY		3.00																		X			
NB	3.855	A	R2-1	24	30																								
		A	R2-1	30	36			7.50																		6			
SIGN SUMMARY SHEET							SHEET TOTALS	44.50	0.00	0	0	0	7	0	0	9	135					PROJECT NAME: East Montpelier-Hartford VT14							
							SF	SF	EA	EA	EA	EA	EA	EA	EA	EA	FT					PROJECT NUMBER: STPG SIGN(21)							
VERMONT AGENCY OF TRANSPORTATION							TOWN TOTALS	973.5	0.0	62.0	9.0	9.0	190	0.0	0.0	152	2280.0					FILE NAME: Royalton.xls							
																						PLOT DATE: 6/10/2009							
																						DRAWN BY: T. Guazzoni							
																					DESIGNED BY: D. Crosslev								
																					CHECKED BY: S. Menard								
																					ROYALTON SHEET 6								
																					SHEET 35 OF 162								

DIRECTION	MILEPOINT	LOCATION CODE (SHEET 2)	SIGN CODE	WIDTH (IN)	HEIGHT (IN)	SHEETING REMARKS	SIGN LEGEND FOR ALL POST LENGTHS AND INSTALLATION DATES SEE ORIGINAL RECORD PLANS	NEW SIGNS		EXISTING SIGNS				EXIST POST		NUMBER OF NEW POSTS	SQUARE STEEL (IN)			TUBULAR STEEL Ø (IN)				SIGN FRAME REQUIRED	REMARKS	SIGN DETAIL		
								"A"	"B"	RETAIN	SALVAGE FROM	SALVAGE TO	REMOVE	RETAIN	REMOVE		1.75	2.00	2.50	3.00	3.50	4.00	5.00			DETAIL IN SHS	DETAIL ON SHEET NUMBER	DETAIL ON STD SHEET NUMBER
																	(LB / FT)			(LB / FT)								
ROYALTON VT 14							FY-FLUORESCENT YELLOW FYG-FLUORESCENT YELLOW GREEN															"SHS"-STANDARD HIGHWAY SIGNS						
NB	3.890	D	R1-1	30	30																							
		D	R1-1	30	30			6.25															X					
NB	3.900	C	VR-017	24	30																			GEE HILL RD TH-5				
		C	VR-017	24	30			5.00																	E-141			
NB	4.090	A	R2-1	24	30																							
		A	R2-1	24	30			5.00															X					
NB	4.170	A	VW-054R	30	30																							
		A	VW-054R	30	30	FY		6.25																	E-154			
NB	4.240	A	R2-1	24	30																							
		A	R2-1	24	30			5.00															X					
NB	4.390	C	VR-017	24	30		LEGAL LOAD LIMIT 24,000 LBS																	LYON RD				
		D	R1-1	24	24																							
		D	R1-1	30	30																		X					
								6.25																				
NB	4.395	C	VR-017	24	30			5.00																	E-141			
NB	4.520	A	R2-1	24	30																							
SIGN SUMMARY SHEET							SHEET TOTALS	38.75	0.00	0	0	0	7	105									PROJECT NAME: East Montpelier-Hartford VT14					
								SF	SF	EA	EA	EA	EA	EA	EA	EA	EA	EA	EA	EA	EA	EA	PROJECT NUMBER: STPG SIGN(21)					
VERMONT AGENCY OF TRANSPORTATION							TOWN TOTALS	973.5	0.0	62.0	9.0	9.0	190	2280.0									FILE NAME: Royalton.xls	PLOT DATE: 6/10/2009				
																						PROJECT MANAGER: N. Avery	DRAWN BY: T. Guazzoni					
																						DESIGNED BY: D. Crossley	CHECKED BY: S. Menard					
																						ROYALTON SHEET 7	SHEET 36 OF 162					

DIRECTION	MILEPOINT	LOCATION CODE (SHEET 2)	SIGN CODE	WIDTH (IN)	HEIGHT (IN)	SHEETING REMARKS	SIGN LEGEND	NEW SIGNS		EXISTING SIGNS				EXIST POST		NUMBER OF NEW POSTS	SQUARE STEEL (IN)			TUBULAR STEEL Ø (IN)				SIGN FRAME REQUIRED	REMARKS	SIGN DETAIL			
								"A"	"B"	RETAIN	SALVAGE FROM	SALVAGE TO	REMOVE	RETAIN	REMOVE		1.75	2.00	2.50	FOUNDATION	3.00	3.50	4.00			5.00	DETAIL IN SHS	DETAIL ON SHEET NUMBER	DETAIL ON STD SHEET NUMBER
																	(LB / FT)				(LB / FT)								
ROYALTON VT 14							FY-FLUORESCENT YELLOW FYG-FLUORESCENT YELLOW GREEN															"SHS"-STANDARD HIGHWAY SIGNS							
			A R2-1	24	30			5.00							1	X									X				
NB	4.940		A W12-2	36	36								1	X															
			A VW-268	36	36								1																
			A W12-2	36	36	FY		9.00																	X				
			A VW-268	36	36	FY		9.00																		6			
NB	5.000		A W1-3R	36	36							1	X																
			A W13-1	24	24							1																	
			A W1-3R	36	36	FY		9.00							2	X									X				
			A W13-1	24	24	FY		4.00																	X				
NB	5.040		A VW-353	30	30							1	X																
			A W16-2	30	24							1																	
			A VW-353	36	36	FY		9.00							2	X										6			
			A W-16-2	30	24	FY		5.00																	X				
NB	5.120		A W12-2	36	36		12' - 1" CLEARANCE UP/DOWN ARROWS			1			X												X				
NB	5.128		A OM-3R	12	36							1	NA																
SIGN SUMMARY SHEET							SHEET TOTALS	50.00	0.00	1	0	0	7	0	0	5	75												
VERMONT AGENCY OF TRANSPORTATION								SF	SF	EA	EA	EA	EA	EA	EA	EA	FT												
							TOWN TOTALS	973.5	0.0	62.0	9.0	9.0	190	0.0	0.0	152	2280.0												
																					PROJECT NAME: East Montpelier-Hartford VT14								
																					PROJECT NUMBER: STPG SIGN(21)								
											FILE NAME: Royalton.xls	PLOT DATE: 6/10/2009																	
											PROJECT MANAGER: N. Avery	DRAWN BY: T. Guazzoni																	
											DESIGNED BY: D. Crosslev	CHECKED BY: S. Menard																	
											ROYALTON SHEET 8	SHEET 37 OF 162																	

DIRECTION	MILEPOINT	LOCATION CODE (SHEET 2)	SIGN CODE	WIDTH (IN)	HEIGHT (IN)	SHEETING REMARKS	SIGN LEGEND FOR ALL POST LENGTHS AND INSTALLATION DATES SEE ORIGINAL RECORD PLANS	NEW SIGNS		EXISTING SIGNS				EXIST POST		NUMBER OF NEW POSTS	SQUARE STEEL (IN) (LB / FT)			TUBULAR STEEL Ø (IN) (LB / FT)				SIGN FRAME REQUIRED	REMARKS	SIGN DETAIL			
								"A"	"B"	RETAIN	SALVAGE FROM	SALVAGE TO	REMOVE	RETAIN	REMOVE		1.75	2.00	2.50	FOUNDATION	3.00	3.50	4.00			5.00	DETAIL IN SHS	DETAIL ON SHEET NUMBER	DETAIL ON STD SHEET NUMBER
																	1.88	2.42	3.35		7.60	9.00	10.80			14.60			
ROYALTON VT 14							FY-FLUORESCENT YELLOW FYG-FLUORESCENT YELLOW GREEN															"SHS"-STANDARD HIGHWAY SIGNS							
			A OM-3R	12	36	FY		3.00							1								BOLT SIGN TO ABUTMENT	X					
NB	5.132		B OM-3R	12	36								1	NA									SIGN BOLTED TO ABUTMENT						
			B OM-3R	12	36	FY		3.00							1								BOLT SIGN TO ABUTMENT	X					
NB	5.149		B W1-6	48	24								1		X														
			B W1-6	48	24			8.00							2		X								X				
NB	5.150		C VR-017	24	30								0		X														
			D R1-1	30	30		STOP						1																
			C VR-017	24	30		 	5.00							1		X								E-141				
NB	5.158		D R1-1	30	30			6.25							1		X							X					
NB	5.160		A W1-6	48	24								1		X														
			A W1-6	48	24			8.00							2		X							X					
NB	5.160		B W1-6	48	24								1		X														
			B W1-6	48	24			8.00							2		X							X					
NB	5.185		A R2-1	24	30								1		X														
			A R2-1	24	30			5.00							1		X							X					
SIGN SUMMARY SHEET							SHEET TOTALS	46.25	0.00	0	0	0	6	0	0	1	135							PROJECT NAME: East Montpelier-Hartford VT14					
VERMONT AGENCY OF TRANSPORTATION								SF	SF	EA	EA	EA	EA	EA	EA	EA	FT							PROJECT NUMBER: STPG SIGN(21)					
							TOWN TOTALS	973.5	0.0	62.0	9.0	9.0	190	0.0	0.0	152	2280.0							FILE NAME: Royalton.xls					
																							DESIGNED BY: D. Crosslev						
																							ROYALTON SHEET 9						
																							PLOT DATE: 6/10/2009						
																							DRAWN BY: T. Guazzoni						
																							CHECKED BY: S. Menard						
																							SHEET 38 OF 162						

DIRECTION	MILEPOINT	LOCATION CODE (SHEET 2)	SIGN CODE	WIDTH (IN)	HEIGHT (IN)	SHEETING REMARKS	SIGN LEGEND	NEW SIGNS		EXISTING SIGNS				EXIST POST		NUMBER OF NEW POSTS	SQUARE STEEL (IN)			TUBULAR STEEL Ø (IN)				SIGN FRAME REQUIRED	REMARKS	SIGN DETAIL			
								"A"	"B"	RETAIN	SALVAGE FROM	SALVAGE TO	REMOVE	RETAIN	REMOVE		1.75	2.00	2.50	FOUNDATION	3.00	3.50	4.00			5.00	DETAIL IN SHS	DETAIL ON SHEET NUMBER	DETAIL ON STD SHEET NUMBER
																	(LB / FT)				(LB / FT)								
ROYALTON VT 14							FY-FLUORESCENT YELLOW FYG-FLUORESCENT YELLOW GREEN															"SHS"-STANDARD HIGHWAY SIGNS							
NB	5.210	A	W11-6	30	30																								
		A	W11-6H	30	30			6.25																HINGED	E-153				
NB	5.270	B	W1-3R	36	36		RIGHT REVERSE TURN																						
		B	W13-1	24	24		20 MPH PLAQUE																						
NB	5.480	A	VW-054	30	30		HIDDEN DRIVES RIGHT																						
		A	R2-1	24	30			5.00																X					
NB	5.520	A	R2-1	24	30		SPEED LIMIT 40																						
		A	VW-054	30	30			6.25																	E-154				
NB	5.580	B	OM1-1	18	18		YELLOW CLUSTER																						
NB	5.660	A	R8-3A	24	24																								
		A	VR-644	24	12																								
		A	R8-3A	24	24			4.00																X					
		A	VR-644	24	12			2.00																	6				
NB	5.760	A	M2-1	21	15																								
		A	M1-5A	24	24																								
SIGN SUMMARY SHEET							SHEET TOTALS	23.50	0.00	0	0	0	10	0	0	4	60							PROJECT NAME: East Montpelier-Hartford VT14					
							SF	SF	EA	EA	EA	EA	EA	EA	EA	EA	FT						PROJECT NUMBER: STPG SIGN(21)						
VERMONT AGENCY OF TRANSPORTATION							TOWN TOTALS	973.5	0.0	62.0	9.0	9.0	190	0.0	0.0	152	2280.0							FILE NAME: Royalton.xls	PLOT DATE: 6/10/2009				
																							PROJECT MANAGER: N. Avery	DRAWN BY: T. Guazzoni					
																							DESIGNED BY: D. Crosslev	CHECKED BY: S. Menard					
																							ROYALTON SHEET 10	SHEET 39 OF 162					

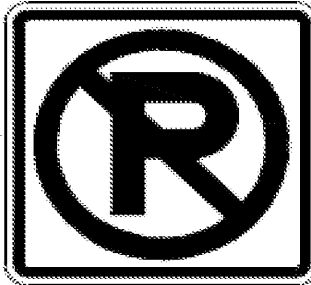
DIRECTION	MILEPOINT	LOCATION CODE (SHEET 2)	SIGN CODE	WIDTH (IN)	HEIGHT (IN)	SHEETING REMARKS	SIGN LEGEND	NEW SIGNS		EXISTING SIGNS				EXIST POST		NUMBER OF NEW POSTS	SQUARE STEEL (IN)			TUBULAR STEEL Ø (IN)				SIGN FRAME REQUIRED	REMARKS	SIGN DETAIL			
								"A"	"B"	RETAIN	SALVAGE FROM	SALVAGE TO	REMOVE	RETAIN	REMOVE		1.75	2.00	2.50	FOUNDATION	3.00	3.50	4.00			5.00	DETAIL IN SHS	DETAIL ON SHEET NUMBER	DETAIL ON STD SHEET NUMBER
																	(LB / FT)				(LB / FT)								
ROYALTON VT 14							FY-FLUORESCENT YELLOW FYG-FLUORESCENT YELLOW GREEN															"SHS"-STANDARD HIGHWAY SIGNS							
			A M2-1	21	15			2.19							1	X								GREEN ON WHITE SHEETING	X				
			A M1-5	24	24			4.00																			E-136B		
NB	5.790		A D1-1A	72	10							1			X														
			A D1-1A	72	10							1																	
			A D1-1A	72	10							1																	
			A D1-1A	72	12			6.00							2	X											5		
			A D1-1A	72	12			6.00																			5		
			A D1-1A	72	12			6.00																			5		
NB	5.794		B W12-2	36	36							1			X														
			B W16-3	24	18							1																	
			B W12-2	36	36	FY		9.00																		X			
			B W16-3	24	18	FY		3.00																	X				
NB	5.810		A R8-3	24	30							1			X														
			A R8-3	24	30			5.00							1	X									X				
NB	5.830		A M4-5	24	12							1			X														
SIGN SUMMARY SHEET							SHEET TOTALS	41.19	0.00	0	0	0	7	0	0	4	60							PROJECT NAME: East Montpelier-Hartford VT14 PROJECT NUMBER: STPG SIGN(21)					
VERMONT AGENCY OF TRANSPORTATION							TOWN TOTALS	973.5	0.0	62.0	9.0	9.0	190	0.0	0.0	152	2280.0							FILE NAME: Royalton.xls PLOT DATE: 6/10/2009 PROJECT MANAGER: N. Avery DRAWN BY: T. Guazzoni DESIGNED BY: D. Crosslev CHECKED BY: S. Menard ROYALTON SHEET 11 SHEET 40 OF 162					



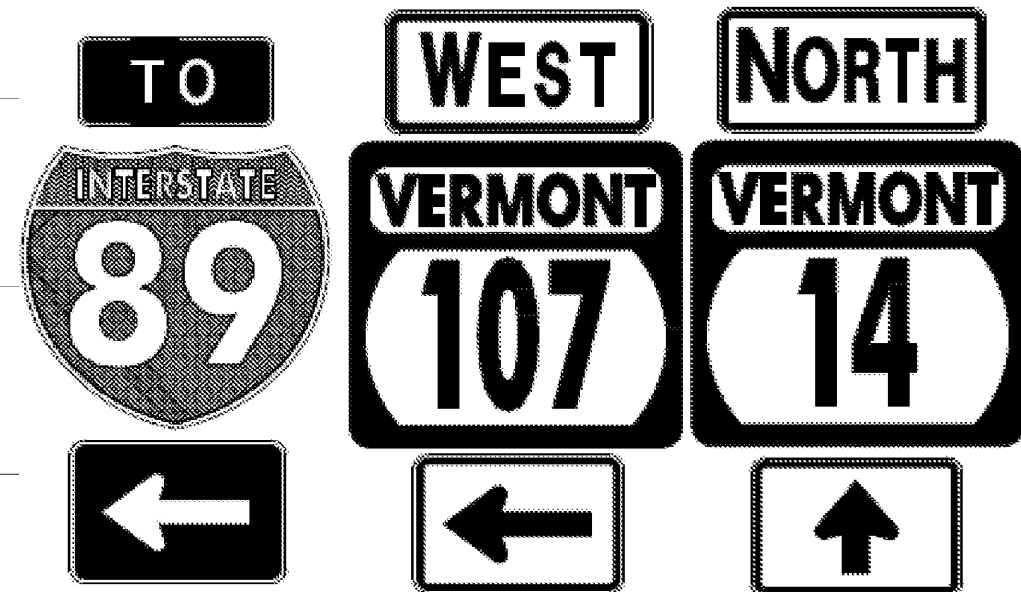



DIRECTION	MILEPOINT	LOCATION CODE (SHEET 2)	SIGN CODE	WIDTH (IN)	HEIGHT (IN)	SHEETING REMARKS	SIGN LEGEND FOR ALL POST LENGTHS AND INSTALLATION DATES SEE ORIGINAL RECORD PLANS	NEW SIGNS		EXISTING SIGNS				EXIST POST		NUMBER OF NEW POSTS	SQUARE STEEL (IN)			TUBULAR STEEL Ø (IN)				SIGN FRAME REQUIRED	REMARKS	SIGN DETAIL							
								"A"	"B"	RETAIN	SALVAGE FROM	SALVAGE TO	REMOVE	RETAIN	REMOVE		1.75	2.00	2.50	FOUNDATION	3.00	3.50	4.00			5.00	DETAIL IN SHS	DETAIL ON SHEET NUMBER	DETAIL ON STD SHEET NUMBER				
																	(LB / FT)				(LB / FT)												
ROYALTON VT 14							FY-FLUORESCENT YELLOW FYG-FLUORESCENT YELLOW GREEN															"SHS"-STANDARD HIGHWAY SIGNS											
			A	M1-1	24	24																											
			A	M6-1	21	15																											
			A	M3-4	24	12																											
			A	M1-5	30	24																											
			A	M6-1	21	15																											
			A	M3-1	24	12																											
			A	M1-5	24	24																											
			A	M6-3	21	15																											
			A	M4-5	24	12																	3B	WHITE ON BLUE SHEETING	X		7						
			A	M1-1	24	24																											
			A	M6-1	21	15																											
			A	M3-4	24	12																											
			A	M1-5	30	24																											
			A	M6-1	21	15																											
			A	M3-1	24	12																											
SIGN SUMMARY SHEET							SHEET TOTALS																										
VERMONT AGENCY OF TRANSPORTATION																																	
TOWN TOTALS							973.5	0.0	62.0	9.0	9.0	190	0.0	0.0	152		2280.0																







2.18
-2.19







2.18
-2.19

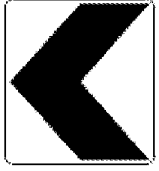
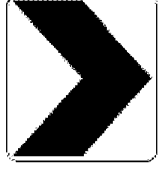

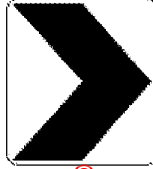
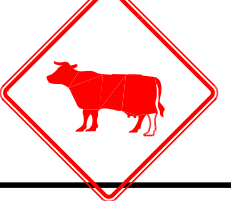



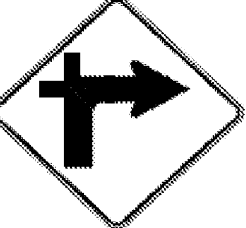

PROJECT NAME: **East Montpelier-Hartford VT14**
PROJECT NUMBER: **STPG SIGN(21)**
FILE NAME: **Royalton.xls** PLOT DATE: **6/10/2009**
PROJECT MANAGER: **N. Avery** DRAWN BY: **T. Guazzoni**
DESIGNED BY: **D. Crosslev** CHECKED BY: **S. Menard**
ROYALTON SHEET 12 SHEET **41** OF **162**

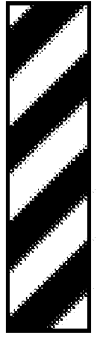



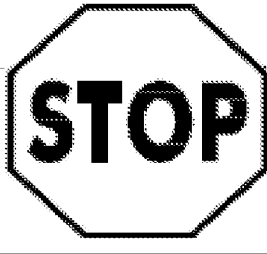
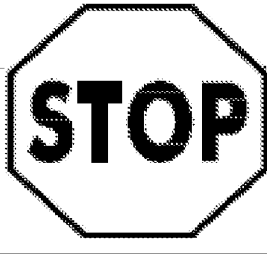
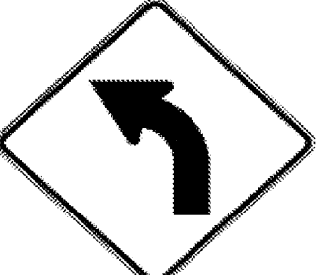

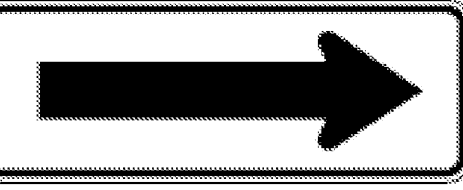
DIRECTION	MILEPOINT	LOCATION CODE (SHEET 2)	SIGN CODE	WIDTH (IN)	HEIGHT (IN)	SHEETING REMARKS	SIGN LEGEND FOR ALL POST LENGTHS AND INSTALLATION DATES SEE ORIGINAL RECORD PLANS	NEW SIGNS		EXISTING SIGNS				EXIST POST		NUMBER OF NEW POSTS	SQUARE STEEL (IN) (LB / FT)			TUBULAR STEEL Ø (IN) (LB / FT)				SIGN FRAME REQUIRED	REMARKS	SIGN DETAIL																							
								"A"	"B"	RETAIN	SALVAGE FROM	SALVAGE TO	REMOVE	RETAIN	REMOVE		1.75	2.00	2.50	FOUNDATION	3.00	3.50	4.00			5.00	DETAIL IN SHS	DETAIL ON SHEET NUMBER	DETAIL ON STD SHEET NUMBER																				
																	1.88	2.42	3.35		7.60	9.00	10.80			14.60																							
ROYALTON VT 14							FY-FLUORESCENT YELLOW FYG-FLUORESCENT YELLOW GREEN															"SHS"-STANDARD HIGHWAY SIGNS																											
		A	M1-5	24	24			4.00																							E-136B																		
		A	M6-3	21	15			2.18 2.19																																									
NB	5.870	A	R8-3A	24	24																																												
		A	M4-6	24	12																																												
		A	R8-3A	24	24			4.00							1																																		
		A	M4-6	24	12			2.00																																									
NB	5.890	A	R2-1	24	30										1																																		
		A	R2-1	24	30			5.00							1																																		
NB	5.940	A	D1-1	72	10																																												
		A	M3-1	24	12																																												
		A	M1-5	24	24																																												
		A	D1-1	72	12			6.00																																									
		A	M3-1	24	12			2.00																																									
		A	M1-5	24	24			4.00							2																																		
SIGN SUMMARY SHEET							SHEET TOTALS	29.18 29.19	0.00	0	0	0	6	0	0	4 2	30																																
VERMONT AGENCY OF TRANSPORTATION							TOWN TOTALS	973.5	0.0	62.0	9.0	9.0	190	0.0	0.0	152	2280.0																																





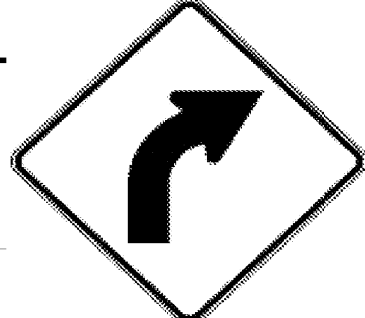

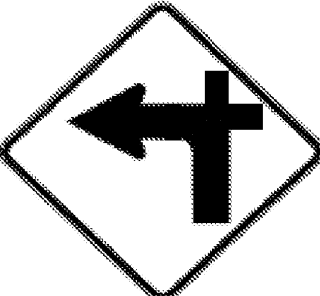

PROJECT NAME: **East Montpelier-Hartford VT14**
PROJECT NUMBER: **STPG SIGN(21)**
FILE NAME: **Royalton.xls** PLOT DATE: **6/10/2009**
PROJECT MANAGER: **N. Avery** DRAWN BY: **T. Guazzoni**
DESIGNED BY: **D. Crossley** CHECKED BY: **S. Menard**
ROYALTON SHEET 13 SHEET **42** OF **162**





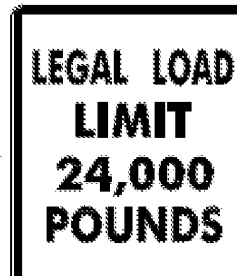

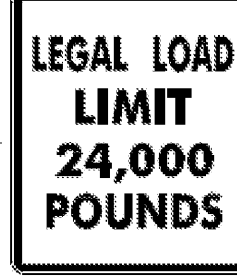
DIRECTION	MILEPOINT	LOCATION CODE (SHEET 2)	SIGN CODE	WIDTH (IN)	HEIGHT (IN)	SHEETING REMARKS	SIGN LEGEND FOR ALL POST LENGTHS AND INSTALLATION DATES SEE ORIGINAL RECORD PLANS	NEW SIGNS		EXISTING SIGNS				EXIST POST		NUMBER OF NEW POSTS	SQUARE STEEL (IN)			TUBULAR STEEL Ø (IN)				SIGN FRAME REQUIRED	REMARKS	SIGN DETAIL			
								"A"	"B"	RETAIN	SALVAGE FROM	SALVAGE TO	REMOVE	RETAIN	REMOVE		1.75	2.00	2.50	FOUNDATION	3.00	3.50	4.00			5.00	DETAIL IN SHS	DETAIL ON SHEET NUMBER	DETAIL ON STD SHEET NUMBER
																	(LB / FT)				(LB / FT)								
ROYALTON VT 14							FY-FLUORESCENT YELLOW FYG-FLUORESCENT YELLOW GREEN															"SHS"-STANDARD HIGHWAY SIGNS							
NB	6.020	A	R2-1	24	30																								
		A	R2-1	24	30			5.00															X						
NB	6.376	C	VR-017	24	30			5.00							1			X							E-141				
NB	6.380	C	VR-017	24	30		LEGAL LOAD LIMIT 24,000 LBS								0														
		D	R1-1	24	24		STOP								0														
NB	6.384	D	R1-1	30	30			6.25										X					X						
NB	6.700	A	W1-2L	30	30		LEFT CURVE								1														
		A	W13-1	18	18		35 MPH PLAQUE								1														
NB	6.770	A	W1-2L	30	30			6.25										X					X						
		A	W13-1	18	18			2.25															X						
NB	6.820	A	W1-8L	12	18			5.00							1										NEW 24X30				
		B	W1-8R	12	18			5.00							1										NEW 24X30				
		A	W1-8L	12	18			1.50							1			X					X		WRONG SIZE PLAN ERROR				
		B	W1-8R	12	18			1.50							1			X					X						
NB	6.840	A	W1-8L	12	18										1														
SIGN SUMMARY SHEET							SHEET TOTALS	37.75 27.75	0.00	0	0	0	9 8	0	0	5	75						PROJECT NAME: East Montpelier-Hartford VT14						
VERMONT AGENCY OF TRANSPORTATION							TOWN TOTALS	973.5	0.0	62.0	9.0	9.0	190	0.0	0.0	152	2280.0						PROJECT NUMBER: STPG SIGN(21)						
								SF	SF	EA	EA	EA	EA	EA	EA	EA	FT					FILE NAME: Royalton.xls	PLOT DATE: 6/10/2009						
																					PROJECT MANAGER: N. Avery	DRAWN BY: T. Guazzoni							
																					DESIGNED BY: D. Crossley	CHECKED BY: S. Menard							
																					ROYALTON SHEET 14	SHEET 43 OF 162							

DIRECTION	MILEPOINT	LOCATION CODE (SHEET 2)	SIGN CODE	WIDTH (IN)	HEIGHT (IN)	SHEETING REMARKS	SIGN LEGEND FOR ALL POST LENGTHS AND INSTALLATION DATES SEE ORIGINAL RECORD PLANS	NEW SIGNS		EXISTING SIGNS				EXIST POST		NUMBER OF NEW POSTS	SQUARE STEEL (IN)			TUBULAR STEEL Ø (IN)				SIGN FRAME REQUIRED	REMARKS	SIGN DETAIL			
								"A"	"B"	RETAIN	SALVAGE FROM	SALVAGE TO	REMOVE	RETAIN	REMOVE		1.75	2.00	2.50	FOUNDATION	3.00	3.50	4.00			5.00	DETAIL IN SHS	DETAIL ON SHEET NUMBER	DETAIL ON STD SHEET NUMBER
																	(LB / FT)				(LB / FT)								
ROYALTON VT 14							FY-FLUORESCENT YELLOW FYG-FLUORESCENT YELLOW GREEN															"SHS"-STANDARD HIGHWAY SIGNS							
			B W1-8R	12	18			5.00															(2) NEW 24X30						
			A W1-8L	12	18			1.50						1			X						WRONG SIZE PLAN ERROR	X					
			B W1-8R	12	18			1.50						1			X							X					
NB	7.300	A	W5-2	30	30		NARROW BRIDGE 	6.25						1			X												
								3.00																					
NB	7.350	A	W5-2	30	30			6.25						1			X						INSTALL 260' +/- NORTH OF ORIGINAL LOCATION REDO PAINTBALL DAMAGE	X					
																													
NB	7.400	A	OM-3R	12	36									1			X												
			A OM-3R	12	36			3.00									X							X					
NB	7.420	B	OM-3L	12	36									1			X												
			B OM-3L	12	36			3.00									X							X					
NB	7.730	A	W5-2	30	30		NARROW BRIDGE							1			X												
NB	7.770	A	W1-1R	30	30									1			X												
			A W13-1	18	18																								
			A W1-1McR	30	30			6.25									X									7			
			A W13-1	18	18			2.25																X					
NB	7.780	A	W5-2	30	30			6.25						1			X						INSTALL 260' +/- NORTH OF ORIGINAL LOCATION	X					
SIGN SUMMARY SHEET							SHEET TOTALS	55.50 30.00	0.00	0	0	0	10 7	0	0	8 7	105							PROJECT NAME: East Montpelier-Hartford VT14 PROJECT NUMBER: STPG SIGN(21)					
VERMONT AGENCY OF TRANSPORTATION							TOWN TOTALS	973.5	0.0	62.0	9.0	9.0	190	0.0	0.0	152	2280.0							FILE NAME: Royalton.xls PROJECT MANAGER: N. Avery DESIGNED BY: D. Crossley ROYALTON SHEET 15	PLOT DATE: 6/10/2009 DRAWN BY: T. Guazzoni CHECKED BY: S. Menard SHEET 44 OF 162				

DIRECTION	MILEPOINT	LOCATION CODE (SHEET 2)	SIGN CODE	WIDTH (IN)	HEIGHT (IN)	SHEETING REMARKS	SIGN LEGEND FOR ALL POST LENGTHS AND INSTALLATION DATES SEE ORIGINAL RECORD PLANS	NEW SIGNS		EXISTING SIGNS				EXIST POST		NUMBER OF NEW POSTS	SQUARE STEEL (IN) (LB / FT)			TUBULAR STEEL Ø (IN) (LB / FT)				SIGN FRAME REQUIRED	REMARKS	SIGN DETAIL			
								"A"	"B"	RETAIN	SALVAGE FROM	SALVAGE TO	REMOVE	RETAIN	REMOVE		1.75	2.00	2.50	FOUNDATION	3.00	3.50	4.00			5.00	DETAIL IN SHS	DETAIL ON SHEET NUMBER	DETAIL ON STD SHEET NUMBER
ROYALTON VT 14							FY-FLUORESCENT YELLOW FYG-FLUORESCENT YELLOW GREEN															"SHS"-STANDARD HIGHWAY SIGNS							
NB	7.870	A	OM-3R	12	36																								
		A	OM-3R	12	36																					X			
NB	7.895	B	OM-3L	12	36																								
		B	OM-3L	12	36																					X			
NB	7.975	C	VR-017	24	30																								
		C	VR-017	24	30																						E-141		
NB	7.985	D	R1-1	24	24																								
		D	R1-1	30	30																					X			
NB	8.095	A	W1-2L	30	30																								
		A	W13-1	18	18																								
NB	8.150	A	W1-6L	48	24																								
NB	8.195	B	W1-6R	48	24																								
NB	9.070	C	VR-017	24	30																								
		C	VR-017	24	30																						E-141		
NB	9.080	D	R1-1	24	24																								
SIGN SUMMARY SHEET							SHEET TOTALS	46.75	0.00	0	0	0	6.5	0	0	10	150							PROJECT NAME: East Montpelier-Hartford VT14					
VERMONT AGENCY OF TRANSPORTATION								SF	SF	EA	EA	EA	EA	EA	EA	EA	FT							PROJECT NUMBER: STPG SIGN(21)					
							TOWN TOTALS	973.5	0.0	62.0	9.0	9.0	190	0.0	0.0	152	2280.0						FILE NAME: Royalton.xls						
																							PROJECT MANAGER: N. Avery						
																							DESIGNED BY: D. Crosslev						
																							ROYALTON SHEET 16						
																							PLOT DATE: 6/10/2009						
																							DRAWN BY: T. Guazzoni						
																							CHECKED BY: S. Menard						
																							SHEET 45 OF 162						

DIRECTION	MILEPOINT	LOCATION CODE (SHEET 2)	SIGN CODE	WIDTH (IN)	HEIGHT (IN)	SHEETING REMARKS	SIGN LEGEND FOR ALL POST LENGTHS AND INSTALLATION DATES SEE ORIGINAL RECORD PLANS	NEW SIGNS		EXISTING SIGNS				EXIST POST		NUMBER OF NEW POSTS	SQUARE STEEL (IN)			TUBULAR STEEL Ø (IN)				SIGN FRAME REQUIRED	REMARKS	SIGN DETAIL			
								"A"	"B"	RETAIN	SALVAGE FROM	SALVAGE TO	REMOVE	RETAIN	REMOVE		1.75	2.00	2.50	FOUNDATION	3.00	3.50	4.00			5.00	DETAIL IN SHS	DETAIL ON SHEET NUMBER	DETAIL ON STD SHEET NUMBER
																	(LB / FT)				(LB / FT)								
ROYALTON VT 14							FY-FLUORESCENT YELLOW FYG-FLUORESCENT YELLOW GREEN															"SHS"-STANDARD HIGHWAY SIGNS							
			D R1-1	30	30			6.25							1		X								X				
NB	9.090		D R1-1	24	24								1			X													
			D R1-1	30	30			6.25							1		X								X				
SB	8.280		F W1-2R	30	30		RIGHT CURVE	6.25					1		X		X									NEW "COW X-ING"			
			F W13-1	18	18		35 MPH PLAQUE	3.00					1													NEW "NEXT 1 MILE"			
SB	8.250		F W1-2R	30	30			6.25							1		X									INSTALL 160'+/- SOUTH OF ORIGINAL SIGN LOCATION			
			F W13-1	18	18			2.25																		X			
SB	8.060		F W1-1MaL	30	30		LEFT TURN						1		X														
			F W13-1	18	18		25 MPH PLAQUE						1																
SB	7.930		F W5-2	30	30		NARROW BRIDGE						1		X														
			F W1-1McL	30	30			6.25							1		X									7			
			F W13-1	18	18			2.25																		X			
SB	7.935		A W1-6L	48	24								1		X														
			A W1-6L	48	24			8.00							2		X									INSTALL 50' +/- NORTH OF GUARD RAIL BEGINNING			
SB	7.934		B W1-6R	48	24								1		X														
SIGN SUMMARY SHEET							SHEET TOTALS	46.75 37.50	0.00	0	0	0	8	0	0	7 6	90										PROJECT NAME: East Montpelier-Hartford VT14 PROJECT NUMBER: STPG SIGN(21)		
VERMONT AGENCY OF TRANSPORTATION							TOWN TOTALS	973.5	0.0	62.0	9.0	9.0	190	0.0	0.0	152	2280.0										FILE NAME: Royalton.xls PROJECT MANAGER: N. Avery DESIGNED BY: D. Crossley ROYALTON SHEET 17		
																										PLOT DATE: 6/10/2009 DRAWN BY: T. Guazzoni CHECKED BY: S. Menard SHEET 46 OF 162			

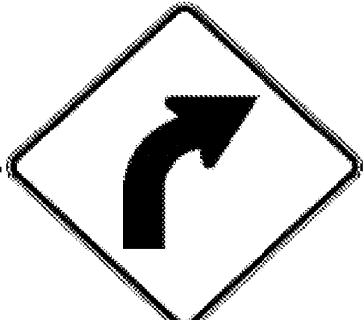
DIRECTION	MILEPOINT	LOCATION CODE (SHEET 2)	SIGN CODE	WIDTH (IN)	HEIGHT (IN)	SHEETING REMARKS	SIGN LEGEND	NEW SIGNS		EXISTING SIGNS				EXIST POST		NUMBER OF NEW POSTS	SQUARE STEEL (IN)			TUBULAR STEEL Ø (IN)				SIGN FRAME REQUIRED	REMARKS	SIGN DETAIL		
								"A"	"B"	RETAIN	SALVAGE FROM	SALVAGE TO	REMOVE	RETAIN	REMOVE		1.75	2.00	2.50	FOUNDATION						DETAIL IN SHS	DETAIL ON SHEET NUMBER	DETAIL ON STD SHEET NUMBER
																	(LB / FT)			3.00	3.50	4.00	5.00					
									1.88	2.42	3.35	7.60	9.00	10.80	14.60													
ROYALTON VT 14							FY-FLUORESCENT YELLOW FYG-FLUORESCENT YELLOW GREEN															"SHS"-STANDARD HIGHWAY SIGNS						
		B	W1-6R	48	24											2		X				INSTALL 100' +/- SOUTH OF GUARD RAIL END	X					
SB	7.930	F	W5-2	30	30											1		X				INSTALL 10' +/- SOUTH OF GUARD RAIL BEGINNING	X					
SB	7.895	F	OM-3R	12	36											1		X										
		F	OM-3R	12	36											1		X					X					
SB	7.870	E	OM-3L	12	36											1		X										
		E	OM-3L	12	36											1		X					X					
SB	7.868	G	VR-017	24	30											1		X				MORSE RD TH-20						
		G	VR-017	24	30											1		X							E-141			
SB	7.864	H	R1-1	24	24											1		X				MORSE RD TH-20						
		H	R1-1	30	30											1		X					X					
SB	7.863	G	VR-017	24	30											1		X				WATERMANN RD TH-21						
		G	VR-017	24	30											1		X							E-141			
SB	7.860	H	R1-1	24	24											1		X				WATERMANN RD TH-21						
		H	R1-1	30	30											1		X					X					
SB	7.860	E	R1-1	48	24											1		X										
SIGN SUMMARY SHEET							SHEET TOTALS	42.75	0.00	0	0	0	7	0	0	9	135						PROJECT NAME: East Montpelier-Hartford VT14					
							SF	SF	EA	EA	EA	EA	EA	EA	EA	EA	FT						PROJECT NUMBER: STPG SIGN(21)					
VERMONT AGENCY OF TRANSPORTATION							TOWN TOTALS	973.5	0.0	62.0	9.0	9.0	190	0.0	0.0	152	2280.0						FILE NAME: Royalton.xls	PLOT DATE: 6/10/2009				
																							PROJECT MANAGER: N. Avery	DRAWN BY: T. Guazzoni				
																							DESIGNED BY: D. Crosslev	CHECKED BY: S. Menard				
																							ROYALTON SHEET 18	SHEET 47 OF 162				

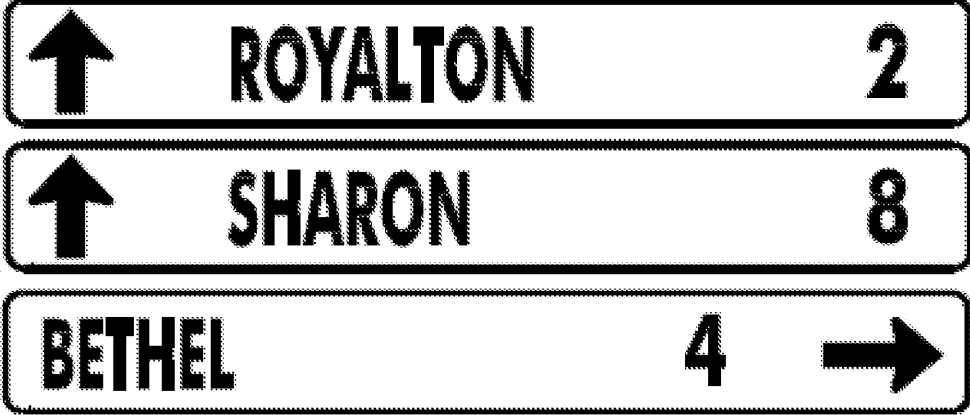

DIRECTION	MILEPOINT	LOCATION CODE (SHEET 2)	SIGN CODE	WIDTH (IN)	HEIGHT (IN)	SHEETING REMARKS	SIGN LEGEND FOR ALL POST LENGTHS AND INSTALLATION DATES SEE ORIGINAL RECORD PLANS	NEW SIGNS		EXISTING SIGNS				EXIST POST		NUMBER OF NEW POSTS	SQUARE STEEL (IN) (LB / FT)			TUBULAR STEEL Ø (IN) (LB / FT)				SIGN FRAME REQUIRED	REMARKS	SIGN DETAIL			
								"A"	"B"	RETAIN	SALVAGE FROM	SALVAGE TO	REMOVE	RETAIN	REMOVE		1.75	2.00	2.50	FOUNDATION	3.00	3.50	4.00			5.00	DETAIL IN SHS	DETAIL ON SHEET NUMBER	DETAIL ON STD SHEET NUMBER
ROYALTON VT 14							FY-FLUORESCENT YELLOW FYG-FLUORESCENT YELLOW GREEN															"SHS"-STANDARD HIGHWAY SIGNS							
			E W1-6	48	24			8.00										X							X				
SB	7.530	F	W5-2	30	30		NARROW BRIDGE																						
SB	7.465	F	W5-2	30	30			6.25										X					INSTALL 350'+/- SOUTH OF ORIGINAL SIGN LOCATION			6			
SB	7.420	F	OM-3R	12	36																								
		F	OM-3R	12	36			3.00										X							X				
SB	7.400	E	OM-3L	12	36																								
		E	OM-3L	12	36			3.00										X							X				
SB	6.930	F	W1-2R	30	30		RIGHT CURVE																						
		F	W13-1	18	18		35 MPH PLAQUE																						
SB	6.980	F	W1-2R	30	30			6.25										X					INSTALL 200'+/- SOUTH OF ORIGINAL SIGN LOCATION			X			
		F	W13-1	18	18			2.25																	X				
SB	6.220	F	W3-5	36	36			9.00										X					INSTALL AT GUARD RAIL END SOUTH OF BRIDGE #26			X			
SB	6.020	F	R2-1	24	30																								
		F	R2-1	30	36			7.50										X									6		
SB	6.000	F	M2-1	21	15																								
SIGN SUMMARY SHEET							SHEET TOTALS	45.25	0.00	0	0	0	6 7	0	0	9	135						PROJECT NAME: East Montpelier-Hartford VT14						
VERMONT AGENCY OF TRANSPORTATION							TOWN TOTALS	973.5	0.0	62.0	9.0	9.0	190	0.0	0.0	152	2280.0					PROJECT NUMBER: STPG SIGN(21)							
								SF	SF	EA	EA	EA	EA	EA	EA	EA	FT					FILE NAME: Royalton.xls	PLOT DATE: 6/10/2009						
																					PROJECT MANAGER: N. Avery	DRAWN BY: T. Guazzoni							
																					DESIGNED BY: D. Crossley	CHECKED BY: S. Menard							
																					ROYALTON SHEET 19	SHEET 48	OF 162						

DIRECTION	MILEPOINT	LOCATION CODE (SHEET 2)	SIGN CODE	WIDTH (IN)	HEIGHT (IN)	SHEETING REMARKS	SIGN LEGEND	NEW SIGNS		EXISTING SIGNS				EXIST POST		NUMBER OF NEW POSTS	SQUARE STEEL (IN)			TUBULAR STEEL Ø (IN)				SIGN FRAME REQUIRED	REMARKS	SIGN DETAIL			
								"A"	"B"	RETAIN	SALVAGE FROM	SALVAGE TO	REMOVE	RETAIN	REMOVE		1.75	2.00	2.50	FOUNDATION	3.00	3.50	4.00			5.00	DETAIL IN SHS	DETAIL ON SHEET NUMBER	DETAIL ON STD SHEET NUMBER
																	(LB / FT)				(LB / FT)								
ROYALTON VT 14							FY-FLUORESCENT YELLOW FYG-FLUORESCENT YELLOW GREEN															"SHS"-STANDARD HIGHWAY SIGNS							
			F M1-5	30	24							1																	
			F M2-1	21	15			2.19							1	X								GREEN ON WHITE SHEETING	X				
			F M1-5	30	24			5.00																		E-136B			
SB	5.950		F D1-1A	72	10							1	X																
			F D1-1A	72	10							1																	
			F D1-1A	72	10							1																	
			F D1-1A	72	12			6.00							2	X										5			
			F D1-1A	72	12			6.00																		5			
			F D1-1A	72	12			6.00																		5			
SB	5.910		F M3-3	24	12						1	X																	
			F M1-5	24	24						1																		
			F M6-3	21	15						1																		
			F M3-4	24	12						1																		
			F M1-5	30	24						1																		
			F M6-1L	21	15						1																		
SIGN SUMMARY SHEET							SHEET TOTALS	25.19	0.00	0	0	0	10	0	0	3	45							PROJECT NAME: East Montpelier-Hartford VT14					
							SF SF EA EA EA EA EA EA EA EA EA																		PROJECT NUMBER: STPG SIGN(21)				
VERMONT AGENCY OF TRANSPORTATION							TOWN TOTALS	973.5	0.0	62.0	9.0	9.0	190	0.0	0.0	152	2280.0							FILE NAME: Royalton.xls					
																										PLOT DATE: 6/10/2009			
																											PROJECT MANAGER: N. Avery		
																											DRAWN BY: T. Guazzoni		
																											DESIGNED BY: D. Crosslev		
																											CHECKED BY: S. Menard		
																											ROYALTON SHEET 20		
																											SHEET 49 OF 162		

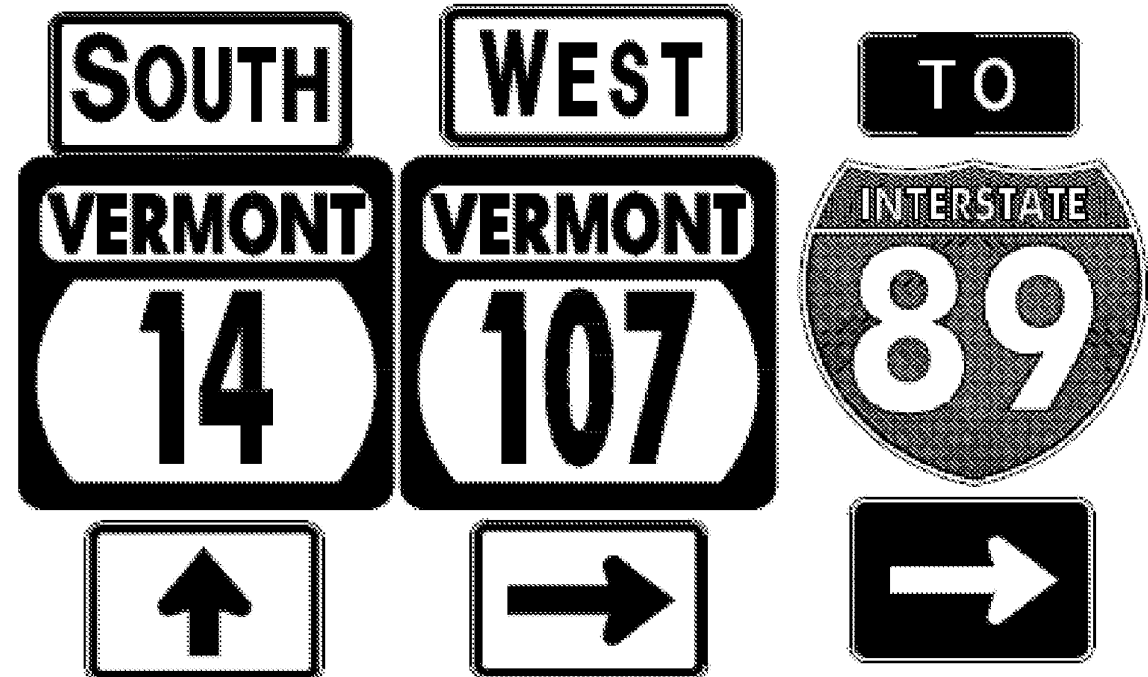



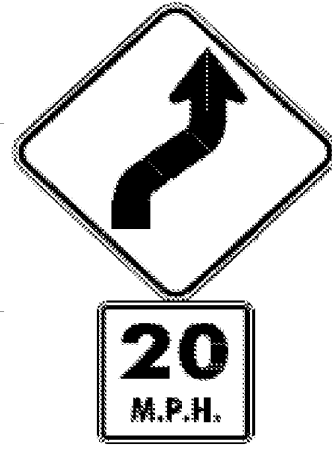

DIRECTION	MILEPOINT	LOCATION CODE (SHEET 2)	SIGN CODE	WIDTH (IN)	HEIGHT (IN)	SHEETING REMARKS	SIGN LEGEND FOR ALL POST LENGTHS AND INSTALLATION DATES SEE ORIGINAL RECORD PLANS	NEW SIGNS		EXISTING SIGNS				EXIST POST		NUMBER OF NEW POSTS	SQUARE STEEL (IN)			TUBULAR STEEL Ø (IN)				SIGN FRAME REQUIRED	REMARKS	SIGN DETAIL					
								"A"	"B"	RETAIN	SALVAGE FROM	SALVAGE TO	REMOVE	RETAIN	REMOVE		1.75	2.00	2.50	FOUNDATION	3.00	3.50	4.00			5.00	DETAIL IN SHS	DETAIL ON SHEET NUMBER	DETAIL ON STD SHEET NUMBER		
																	(LB / FT)				(LB / FT)										
ROYALTON VT 14							FY-FLUORESCENT YELLOW FYG-FLUORESCENT YELLOW GREEN															"SHS"-STANDARD HIGHWAY SIGNS									
			F M4-5	24	12								1																		
			F M1-1	24	24								1																		
			F M6-1L	21	15								1																		
			F M3-3	24	12						2.00													3B	GREEN ON WHITE SHEETING	X		7			
			F M1-5	24	24						4.00																			E-136B	
			F M6-3	21	15						2.18 2.19															GREEN ON WHITE SHEETING	X				
			F M3-4	24	12						2.00															GREEN ON WHITE SHEETING	X				
			F M1-5	30	24						5.00																			E-136B	
			F M6-1L	21	15						2.18 2.19															GREEN ON WHITE SHEETING	X				
			F M4-5	24	12						2.00															WHITE ON BLUE SHEETING	X				
			F M1-1	24	24						4.00																	X			
			F M6-1L	21	15						2.18 2.19															WHITE ON BLUE SHEETING	X				
			F M3-3	24	12																										
			F M1-5	24	24																										
			F M3-3	24	12						2.00							X								GREEN ON WHITE SHEETING	X				
SIGN SUMMARY SHEET							SHEET TOTALS	27.54 27.57	0.00	0	0	0	5	0	0	1	15				PROJECT NAME: East Montpelier-Hartford VT14 PROJECT NUMBER: STPG SIGN(21)										
VERMONT AGENCY OF TRANSPORTATION							TOWN TOTALS	973.5	0.0	62.0	9.0	9.0	190	0.0	0.0	152	2280.0				FILE NAME: Royalton.xls PLOT DATE: 6/10/2009 PROJECT MANAGER: N. Avery DRAWN BY: T. Guazzoni DESIGNED BY: D. Crosslev CHECKED BY: S. Menard ROYALTON SHEET 21 SHEET 50 OF 162										













DIRECTION	MILEPOINT	LOCATION CODE (SHEET 2)	SIGN CODE	WIDTH (IN)	HEIGHT (IN)	SHEETING REMARKS	SIGN LEGEND	NEW SIGNS		EXISTING SIGNS				EXIST POST		NUMBER OF NEW POSTS	SQUARE STEEL (IN)			TUBULAR STEEL Ø (IN)				SIGN FRAME REQUIRED	REMARKS	SIGN DETAIL					
								"A"	"B"	RETAIN	SALVAGE FROM	SALVAGE TO	REMOVE	RETAIN	REMOVE		1.75	2.00	2.50	FOUNDATION	3.00	3.50	4.00			5.00	DETAIL IN SHS	DETAIL ON SHEET NUMBER	DETAIL ON STD SHEET NUMBER		
																	(LB / FT)				(LB / FT)										
ROYALTON VT 14							FY-FLUORESCENT YELLOW FYG-FLUORESCENT YELLOW GREEN															"SHS"-STANDARD HIGHWAY SIGNS									
			F M1-5	24	24			4.00																			E-136B				
SB	5.793		F W12-2	36	36							1	X																		
			F W16-3	24	18																										
			F W12-2	36	36	FY			9.00																			X			
			F W16-3	24	18	FY			3.00																			X			
SB	5.730		F R2-1	24	30							1	X																		
			F R2-1	24	30				5.00						1		X											X			
SB	5.700		F D1-1	72	10		 																								
			F D1-1	72	10																										
			F D1-1	72	12				6.00																			5			
			F D1-1	72	12				6.00																			5			
SB	5.660		F W2-2R	30	30		RIGHT SIDE ROAD							1	X																
			F W13-1	18	18		35 MPH PLAQUE							1																	
SB	5.625		F W2-2R	30	30			6.25																				INSTALL 185'+/- SOUTH OF ORIGINAL SIGN LOCATION			
			F W13-1	18	18				2.25																			X			
SIGN SUMMARY SHEET							SHEET TOTALS	41.50	0.00	0	0	0	7	0	0	4		60													
VERMONT AGENCY OF TRANSPORTATION							TOWN TOTALS	973.5	0.0	62.0	9.0	9.0	190	0.0	0.0	152		2280.0													
																PROJECT NAME:	East Montpelier-Hartford VT14														
																PROJECT NUMBER:	STPG SIGN(21)														
																FILE NAME:	Royalton.xls														
																PROJECT MANAGER:	N. Avery														
																DESIGNED BY:	D. Crosslev														
																ROYALTON SHEET	22														
																PLOT DATE:	6/10/2009														
																DRAWN BY:	T. Guazzoni														
																CHECKED BY:	S. Menard														
																SHEET	51				OF 162										

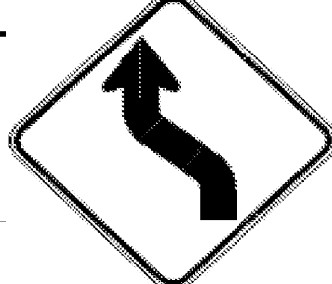

DIRECTION	MILEPOINT	LOCATION CODE (SHEET 2)	SIGN CODE	WIDTH (IN)	HEIGHT (IN)	SHEETING REMARKS	SIGN LEGEND FOR ALL POST LENGTHS AND INSTALLATION DATES SEE ORIGINAL RECORD PLANS	NEW SIGNS		EXISTING SIGNS				EXIST POST		NUMBER OF NEW POSTS	SQUARE STEEL (IN)			TUBULAR STEEL Ø (IN)				SIGN FRAME REQUIRED	REMARKS	SIGN DETAIL			
								"A"	"B"	RETAIN	SALVAGE FROM	SALVAGE TO	REMOVE	RETAIN	REMOVE		1.75	2.00	2.50	FOUNDATION	3.00	3.50	4.00			5.00	DETAIL IN SHS	DETAIL ON SHEET NUMBER	DETAIL ON STD SHEET NUMBER
																	(LB / FT)				(LB / FT)								
ROYALTON VT 14							FY-FLUORESCENT YELLOW FYG-FLUORESCENT YELLOW GREEN															"SHS"-STANDARD HIGHWAY SIGNS							
SB	5.539	C	UNK	24	30		BRIDGE WEIGHT LIMITS (TOWN SIGN)				1				1		X							ROYALTON HILL RD TH-6					
SB	5.547	C	UNK	24	30		BRIDGE WEIGHT LIMITS (TOWN SIGN) ON BACK OF STOP SIGN			1																			
SB	5.547	H	R1-1	24	24							1				X								ROYALTON HILL RD TH-6					
		H	R1-1	30	30				6.25						1		X								X				
SB	5.440	F	R2-1	24	30							1			X														
		F	R2-1	24	30				5.00						1		X								X				
SB	5.300	A	W12-2	36	36							1				X													
		A	VW-268	30	30							1																	
		A	W12-2	36	36	FY			9.00						2		X								X				
		A	VW-268	30	30	FY			6.25																		6		
SB	5.260	F	W1-3R	30	48							1				X													
		F	W13-1	18	18							1																	
		F	W1-3R	36	36	FY			9.00						2		X								X				
		F	W13-1	24	24	FY			4.00																X				
SB	5.210	F	VW-353	36	36	FY		9.00				2				X										6			
SIGN SUMMARY SHEET							SHEET TOTALS	48.50	0.00	0	1	1	6	0	0	9	135							PROJECT NAME: East Montpelier-Hartford VT14					
VERMONT AGENCY OF TRANSPORTATION							TOWN TOTALS	973.5	0.0	62.0	9.0	9.0	190	0.0	0.0	152	2280.0							PROJECT NUMBER: STPG SIGN(21)	FILE NAME: Royalton.xls	PLOT DATE: 6/10/2009			
								SF	SF	EA	EA	EA	EA	EA	EA	EA	FT							PROJECT MANAGER: N. Avery	DRAWN BY: T. Guazzoni				
																							DESIGNED BY: D. Crossley	CHECKED BY: S. Menard					
																							ROYALTON SHEET 23	SHEET 52	OF 162				



DIRECTION	MILEPOINT	LOCATION CODE (SHEET 2)	SIGN CODE	WIDTH (IN)	HEIGHT (IN)	SHEETING REMARKS	SIGN LEGEND FOR ALL POST LENGTHS AND INSTALLATION DATES SEE ORIGINAL RECORD PLANS	NEW SIGNS		EXISTING SIGNS				EXIST POST		NUMBER OF NEW POSTS	SQUARE STEEL (IN)			TUBULAR STEEL Ø (IN)				SIGN FRAME REQUIRED	REMARKS	SIGN DETAIL			
								"A"	"B"	RETAIN	SALVAGE FROM	SALVAGE TO	REMOVE	RETAIN	REMOVE		1.75	2.00	2.50	FOUNDATION	3.00	3.50	4.00			5.00	DETAIL IN SHS	DETAIL ON SHEET NUMBER	DETAIL ON STD SHEET NUMBER
																	(LB / FT)				(LB / FT)								
ROYALTON VT 14							FY-FLUORESCENT YELLOW FYG-FLUORESCENT YELLOW GREEN																"SHS"-STANDARD HIGHWAY SIGNS						
			F W16-2	30	24	FY		5.00																		X			
SB	5.140		F W12-2	36	36								1	X															
			F W12-2	36	36	FY		9.00																		X			
SB	5.132		B OM-3R	12	36								1	NA															
			B OM-3R	12	36	FY		3.00							1	NA									X				
SB	5.128		A OM-3R	12	36								1	NA															
			A OM-3R	12	36	FY		3.00							1		X								X				
SB	5.120		E W1-6	48	24								1		X														
			E W1-6	48	24	FY		8.00							2		X								X				
SB	5.110		E W1-6	48	24								1		X	1													
			E W1-6	48	24	FY		8.00							2		X								X				
SB	5.080		F R2-1	24	30								1		X	1													
			F R2-1	24	30			5.00																					
			F R2-1	24	30			5.00																	X				
SB	5.000		E W1-3R	36	36		RIGHT REVERSE TURN						1		X														
			E W13-1	24	24		20 MPH PLAQUE						1																
SIGN SUMMARY SHEET							SHEET TOTALS	46.00 41.00	0.00	0	0	0	8	0	0	10 6	90												
VERMONT AGENCY OF TRANSPORTATION							TOWN TOTALS	973.5	0.0	62.0	9.0	9.0	190	0.0	0.0	152	2280.0												
PROJECT NAME: East Montpelier-Hartford VT14																					PROJECT NUMBER: STPG SIGN(21)								
FILE NAME: Royalton.xls												PLOT DATE: 6/10/2009																	
PROJECT MANAGER: N. Avery												DRAWN BY: T. Guazzoni																	
DESIGNED BY: D. Crossley												CHECKED BY: S. Menard																	
ROYALTON SHEET 24												SHEET 53 OF 162																	

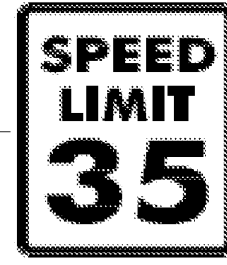

DIRECTION	MILEPOINT	LOCATION CODE (SHEET 2)	SIGN CODE	WIDTH (IN)	HEIGHT (IN)	SHEETING REMARKS	SIGN LEGEND FOR ALL POST LENGTHS AND INSTALLATION DATES SEE ORIGINAL RECORD PLANS	NEW SIGNS		EXISTING SIGNS				EXIST POST		NUMBER OF NEW POSTS	SQUARE STEEL (IN) (LB / FT)			TUBULAR STEEL Ø (IN) (LB / FT)				SIGN FRAME REQUIRED	REMARKS	SIGN DETAIL			
								"A"	"B"	RETAIN	SALVAGE FROM	SALVAGE TO	REMOVE	RETAIN	REMOVE		1.75	2.00	2.50	FOUNDATION	3.00	3.50	4.00			5.00	DETAIL IN SHS	DETAIL ON SHEET NUMBER	DETAIL ON STD SHEET NUMBER
																	1.88	2.42	3.35		7.60	9.00	10.80			14.60			
ROYALTON VT 14							FY-FLUORESCENT YELLOW FYG-FLUORESCENT YELLOW GREEN															"SHS"-STANDARD HIGHWAY SIGNS							
SB	4.725	F	W3-5	36	36			9.00							2	X								INSTALL 350'+/- NORTH OF STANDING STONE PERENNIAL FARM SIGN.	X				
SB	4.650	F	VD-062B	72	16		BUSINESS SIGN			1																			
SB	4.610	F	VD-018	30	18																								
		F	VD-018	30	18			3.75							1													E-128B	
SB	4.520	F	R2-1	24	30																								
		F	R2-1	30	36			7.50							1	X												6	
SB	4.530	F	W10-3L	30	30		LEFT SIDE ROAD W/TRACKS																						
SB	4.323	G	VR-017	24	24																								BRIDGE STREET TH-101
		G	VR-017	24	30			5.00							1	X													
SB	4.320	H	R1-1	24	24																								
		H	R1-1	30	30			6.25							1	X													
SB	4.300	F	R2-1	24	30																								
		F	R2-1	24	30			5.00							1	X												X	
SB	4.267	G	VR-017	24	30			5.00							1	X												BRIDGE STREET FORK TH-5	E-141
SB	4.250	H	R1-1	30	30		STOP																						
SIGN SUMMARY SHEET							SHEET TOTALS	41.50	0.00	1	0	0	0	0	0	0	0	105											
VERMONT AGENCY OF TRANSPORTATION							TOWN TOTALS	973.5	0.0	62.0	9.0	9.0	190	0.0	0.0	152	2280.0												
PROJECT NAME: East Montpelier-Hartford VT14																						PROJECT NUMBER: STPG SIGN(21)							
FILE NAME: Royalton.xls										PLOT DATE: 6/10/2009					DRAWN BY: T. Guazzoni														
PROJECT MANAGER: N. Avery										DESIGNED BY: D. Crosslev					CHECKED BY: S. Menard														
ROYALTON SHEET 25																						SHEET 54 OF 162							

DIRECTION	MILEPOINT	LOCATION CODE (SHEET 2)	SIGN CODE	WIDTH (IN)	HEIGHT (IN)	SHEETING REMARKS	SIGN LEGEND FOR ALL POST LENGTHS AND INSTALLATION DATES SEE ORIGINAL RECORD PLANS	NEW SIGNS		EXISTING SIGNS				EXIST POST		NUMBER OF NEW POSTS	SQUARE STEEL (IN) (LB / FT)			TUBULAR STEEL Ø (IN) (LB / FT)				SIGN FRAME REQUIRED	REMARKS	SIGN DETAIL									
								"A"	"B"	RETAIN	SALVAGE FROM	SALVAGE TO	REMOVE	RETAIN	REMOVE		FOUNDATION	1.75	2.00	2.50	3.00	3.50	4.00			5.00	DETAIL IN SHS	DETAIL ON SHEET NUMBER	DETAIL ON STD SHEET NUMBER						
																		1.88	2.42	3.35	7.60	9.00	10.80			14.60									
ROYALTON VT 14							FY-FLUORESCENT YELLOW FYG-FLUORESCENT YELLOW GREEN															"SHS"-STANDARD HIGHWAY SIGNS													
			G VR-017	24	30		LEGAL LOAD LIMIT 24,000 LBS																												
			H R1-1	30	30			6.25																										X	
SB	4.182		G VR-017	24	30																														
			G VR-017	24	30			5.00																											E-141
SB	4.181		H R1-1	30	30																														
			H R1-1	30	30			6.25																										X	
SB	4.180		F R2-1	24	30																														
			F R2-1	24	30			5.00																										X	
SB	3.980		F VW-268	30	30		NARROW UNDERPASS																												6
SB	3.930		F W1-3L	30	30		LEFT REVERSE TURN																												
			F W13-1	18	18		25 MPH PLAQUE																												
SB	3.890		F W1-3L	30	30			6.25																										X	
			F W13-1	18	18			2.25																										X	
SB	3.840		F VW-268	30	30			6.25																											6
SB	3.840		F W1-6	48	24																														
SIGN SUMMARY SHEET							SHEET TOTALS	37.25	0.00	0	0	0	8	0	0	3	45						PROJECT NAME: East Montpelier-Hartford VT14												
VERMONT AGENCY OF TRANSPORTATION							TOWN TOTALS	973.5	0.0	62.0	9.0	9.0	190	0.0	0.0	152	2280.0						PROJECT NUMBER: STPG SIGN(21)												
								SF	SF	EA	EA	EA	EA	EA	EA	EA	FT						FILE NAME: Royalton.xls		PLOT DATE: 6/10/2009										
																							PROJECT MANAGER: N. Avery		DRAWN BY: T. Guazzoni										
																							DESIGNED BY: D. Crossley		CHECKED BY: S. Menard										
																							ROYALTON SHEET 26		SHEET 55 OF 162										



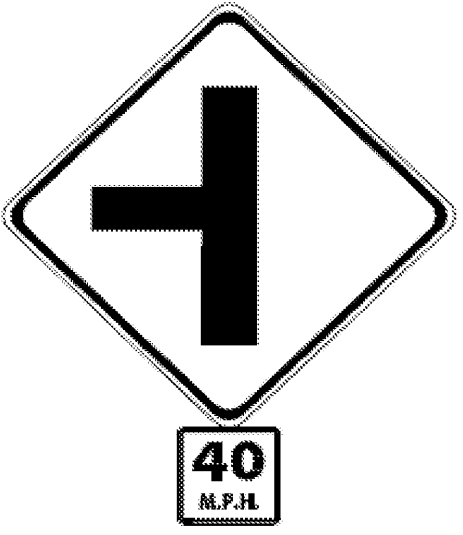

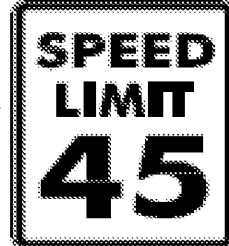
DIRECTION	MILEPOINT	LOCATION CODE (SHEET 2)	SIGN CODE	WIDTH (IN)	HEIGHT (IN)	SHEETING REMARKS	SIGN LEGEND FOR ALL POST LENGTHS AND INSTALLATION DATES SEE ORIGINAL RECORD PLANS	NEW SIGNS		EXISTING SIGNS				EXIST POST		NUMBER OF NEW POSTS	SQUARE STEEL (IN)			TUBULAR STEEL Ø (IN)				SIGN FRAME REQUIRED	REMARKS	SIGN DETAIL			
								"A"	"B"	RETAIN	SALVAGE FROM	SALVAGE TO	REMOVE	RETAIN	REMOVE		1.75	2.00	2.50	FOUNDATION	3.00	3.50	4.00			5.00	DETAIL IN SHS	DETAIL ON SHEET NUMBER	DETAIL ON STD SHEET NUMBER
																	(LB / FT)				(LB / FT)								
ROYALTON VT 14							FY-FLUORESCENT YELLOW FYG-FLUORESCENT YELLOW GREEN															"SHS"-STANDARD HIGHWAY SIGNS							
			F W1-6	48	24			8.00							2	X								X					
SB	3.835	A	OM-3R	12	36								1			X													
		A	OM-3R	12	36	FY		3.00						1		X								X					
SB	3.825	B	OM-3L	12	36								1			X													
		B	OM-3L	12	36	FY		3.00						1		X								X					
SB	3.750	F	R2-1	24	30								1			X													
		F	R2-1	24	30			5.00						1		X								X					
SB	3.640	E	W1-3L	30	30		LEFT REVERSE TURN						1			X													
		E	W13-1	18	18		25 MPH PLAQUE						1																
SB	3.526	F	W1-2R	30	30		RIGHT CURVE				1	1				X	1	X											
		F	W13-1	24	24		35 MPH PLAQUE				1	1																	
SB	3.500	C	UNK	24	30		NO PARKING BETWEEN SIGNS						1			X													
SB	3.310	F	W1-4R	30	30		RIGHT REVERSE CURVE			1						X													
SB	3.300	F	W13-1	24	24		35 MPH			1						X													
SB	3.118	G	VR-023B	24	30		\$500 FINE FOR THROWING TRASH ON HIGHWAYS AND STREAMS			1						X													
SIGN SUMMARY SHEET							SHEET TOTALS	19.00	0.00	3	2	2	6	0	0	6	90												
VERMONT AGENCY OF TRANSPORTATION								SF	SF	EA	EA	EA	EA	EA	EA	EA	FT												
TOWN TOTALS							TOWN TOTALS	973.5	0.0	62.0	9.0	9.0	190	0.0	0.0	152	2280.0												
															PROJECT NAME: East Montpelier-Hartford VT14														
															PROJECT NUMBER: STPG SIGN(21)														
															FILE NAME: Royalton.xls					PLOT DATE: 6/10/2009									
															PROJECT MANAGER: N. Avery					DRAWN BY: T. Guazzoni									
															DESIGNED BY: D. Crossley					CHECKED BY: S. Menard									
															ROYALTON SHEET 27					SHEET 56 OF 162									

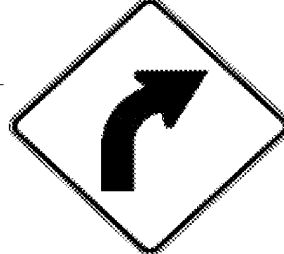



DIRECTION	MILEPOINT	LOCATION CODE (SHEET 2)	SIGN CODE	WIDTH (IN)	HEIGHT (IN)	SHEETING REMARKS	SIGN LEGEND FOR ALL POST LENGTHS AND INSTALLATION DATES SEE ORIGINAL RECORD PLANS	NEW SIGNS		EXISTING SIGNS				EXIST POST		NUMBER OF NEW POSTS	SQUARE STEEL (IN)			TUBULAR STEEL Ø (IN)				SIGN FRAME REQUIRED	REMARKS	SIGN DETAIL			
								"A"	"B"	RETAIN	SALVAGE FROM	SALVAGE TO	REMOVE	RETAIN	REMOVE		1.75	2.00	2.50	FOUNDATION	3.00	3.50	4.00			5.00	DETAIL IN SHS	DETAIL ON SHEET NUMBER	DETAIL ON STD SHEET NUMBER
																	(LB / FT)				(LB / FT)								
ROYALTON VT 14							FY-FLUORESCENT YELLOW FYG-FLUORESCENT YELLOW GREEN															"SHS"-STANDARD HIGHWAY SIGNS							
SB	2.890	F	W1-10R	30	30		MODIFIED RIGHT CURVE			1						X													
SB	2.820	C	R1-1	30	30		STOP																						
SB	2.750	F	VD-062B	72	16		BUSINESS SIGN			1						X													
		F	VD-062AL	72	16		BUSINESS SIGN			1																			
		F	VD-062B	72	16		BUSINESS SIGN			1																			
SB	2.695	F	W3-5	36	36		SPEED REDUCTION SPEED LIMIT 35			1						X													
SB	2.610	F	VW-054L	30	30		HIDDEN DRIVE LEFT																						
		F	VW-202	30	30		TRUCKS ENTERING																						
SB	2.590	F	R2-1	24	30																								
		F	R2-1	30	36					7.50																			6
SB	2.520	F	VD-018	30	18			3.75																					
		F	VD-018	30	18					3.75																			
SB	2.484	F	M2-1S	21	15		JCT			1						X													
		F	M1-5	30	24		VERMONT 110			1																			
SB	2.443	F	W11-2YG	30	30		PEDESTRIAN SYMBOL			1						X													
		F	W16-9	24	10		AHEAD			1																			
SIGN SUMMARY SHEET							SHEET TOTALS	15.00 11.25	0.00	9	0	0	5 4	0	0	1	15						PROJECT NAME: East Montpelier-Hartford VT14 PROJECT NUMBER: STPG SIGN(21)						
VERMONT AGENCY OF TRANSPORTATION							TOWN TOTALS	973.5	0.0	62.0	9.0	9.0	190	0.0	0.0	152	2280.0						FILE NAME: Royalton.xls PROJECT MANAGER: N. Avery DESIGNED BY: D. Crosslev ROYALTON SHEET 28	PLOT DATE: 6/10/2009 DRAWN BY: T. Guazzoni CHECKED BY: S. Menard SHEET 57 OF 162					



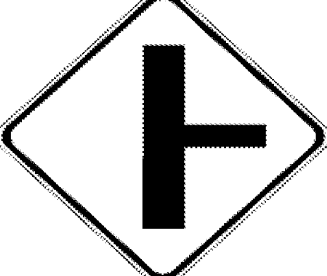
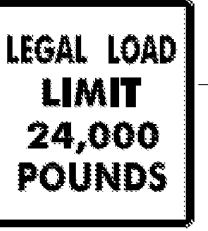



DIRECTION	MILEPOINT	LOCATION CODE (SHEET 2)	SIGN CODE	WIDTH (IN)	HEIGHT (IN)	SHEETING REMARKS	SIGN LEGEND	NEW SIGNS		EXISTING SIGNS				EXIST POST		NUMBER OF NEW POSTS	SQUARE STEEL (IN)			TUBULAR STEEL Ø (IN)				SIGN FRAME REQUIRED	REMARKS	SIGN DETAIL				
								"A"	"B"	RETAIN	SALVAGE FROM	SALVAGE TO	REMOVE	RETAIN	REMOVE		1.75	2.00	2.50	3.00	3.50	4.00	5.00			DETAIL IN SHS	DETAIL ON SHEET NUMBER	DETAIL ON STD SHEET NUMBER		
																	(LB / FT)			(LB / FT)										
ROYALTON VT 14							FY-FLUORESCENT YELLOW FYG-FLUORESCENT YELLOW GREEN															"SHS"-STANDARD HIGHWAY SIGNS								
SB	2.276	F	D2-1	72	10																									
		F	D2-1	72	12			6.00																	5					
		F	M3-3S	24	12	SOUTH						1														INSTALL ON LEFT POST				
		F	M1-5	24	24	VERMONT 14						1														INSTALL ON LEFT POST				
SB	2.048	F	R2-1	24	30		SPEED LIMIT 50			1																				
SB	1.660	F	R2-5A	24	30		REDUCED SPEED AHEAD					1																		
SB	1.610	F	VD-062B	72	16		BUSINESS SIGN			1																				
SB	1.560	F	VW-060	30	30							1																		
		F	VW-060	30	30			6.25	1																	E-154				
SB	1.520	F	R2-1	24	30							1																		
		F	R2-1	30	36			7.50																	6					
SB	1.460	F	W2-2L	30	30							1																		
		F	W13-1	18	18							1																		
		F	W2-2L	30	30			6.25																	X					
		F	W13-1	18	18			2.25																	X					
SIGN SUMMARY SHEET							SHEET TOTALS	28.25	0.00	3	0	2	6	0	0	4	60						PROJECT NAME: East Montpelier-Hartford VT14							
							SF SF EA EA EA EA EA EA EA EA								FT							PROJECT NUMBER: STPG SIGN(21)								
VERMONT AGENCY OF TRANSPORTATION							TOWN TOTALS	973.5	0.0	62.0	9.0	9.0	190	0.0	0.0	152	2280.0						FILE NAME: Royalton.xls							
																								PLOT DATE: 6/10/2009						
																									DRAWN BY: T. Guazzoni					
																										DESIGNED BY: D. Crosslev				
																										CHECKED BY: S. Menard				
																										ROYALTON SHEET 30				
																										SHEET 59 OF 162				



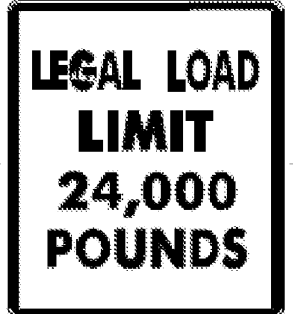

DIRECTION	MILEPOINT	LOCATION CODE (SHEET 2)	SIGN CODE	WIDTH (IN)	HEIGHT (IN)	SHEETING REMARKS	SIGN LEGEND	NEW SIGNS		EXISTING SIGNS				EXIST POST		NUMBER OF NEW POSTS	SQUARE STEEL (IN)			TUBULAR STEEL Ø (IN)				SIGN FRAME REQUIRED	REMARKS	SIGN DETAIL				
								"A"	"B"	RETAIN	SALVAGE FROM	SALVAGE TO	REMOVE	RETAIN	REMOVE		1.75	2.00	2.50	FOUNDATION	3.00	3.50	4.00			5.00	DETAIL IN SHS	DETAIL ON SHEET NUMBER	DETAIL ON STD SHEET NUMBER	
																	(LB / FT)				(LB / FT)									
ROYALTON VT 14							FY-FLUORESCENT YELLOW FYG-FLUORESCENT YELLOW GREEN															"SHS"-STANDARD HIGHWAY SIGNS								
SB	1.300	F	R2-1	24	30																									
		F	R2-1	24	30			5.00																	X					
SB	1.130	F	R2-1	24	30																									
		F	R2-1	24	30			5.00																	X					
SB	0.960	F	W1-2R	30	30																									
		F	W1-2R	30	30			6.25																						
SIGN SUMMARY SHEET							SHEET TOTALS	16.25	0.00	0	0	0	3	0	0	0	0								PROJECT NAME: East Montpelier-Hartford VT14					
							SF	SF	EA	EA	EA	EA	EA	EA	EA	EA	EA	EA	EA	EA	EA	EA	EA	EA	PROJECT NUMBER: STPG SIGN(21)					
VERMONT AGENCY OF TRANSPORTATION							TOWN TOTALS	973.5	0.0	62.0	9.0	9.0	190	0.0	0.0	152				2280.0						FILE NAME: Royalton.xls				
																									PLOT DATE: 6/10/2009					
																									DRAWN BY: T. Guazzoni					
																										DESIGNED BY: D. Crosslev				
																										CHECKED BY: S. Menard				
																										ROYALTON SHEET 31				
																										SHEET 60 OF 162				





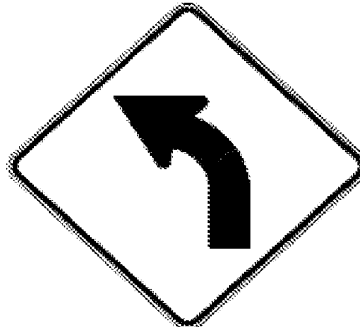

DIRECTION	MILEPOINT	LOCATION CODE (SHEET 2)	SIGN CODE	WIDTH (IN)	HEIGHT (IN)	SHEETING REMARKS	SIGN LEGEND FOR ALL POST LENGTHS AND INSTALLATION DATES SEE ORIGINAL RECORD PLANS	NEW SIGNS		EXISTING SIGNS				EXIST POST		NUMBER OF NEW POSTS	SQUARE STEEL (IN)			TUBULAR STEEL Ø (IN)				SIGN FRAME REQUIRED	REMARKS	SIGN DETAIL			
								"A"	"B"	RETAIN	SALVAGE FROM	SALVAGE TO	REMOVE	RETAIN	REMOVE		1.75	2.00	2.50	FOUNDATION	3.00	3.50	4.00			5.00	DETAIL IN SHS	DETAIL ON SHEET NUMBER	DETAIL ON STD SHEET NUMBER
																	(LB / FT)				(LB / FT)								
BETHEL VT 14							FY-FLUORESCENT YELLOW FYG-FLUORESCENT YELLOW GREEN															"SHS"-STANDARD HIGHWAY SIGNS							
NB	0.000	C	VD-024	72	10			5.00										X								E-128B			
NB	0.120	A	W1-4L	30	30																								
NB	0.190	A	W1-4L	30	30			6.25										X							X	INSTALL 425' +/- NORT OF ORIGINAL SIGN LOCATION			
NB	0.400	A	VD-018	30	18																								
		A	VD-018	30	18			3.75										X								E-128B			
NB	0.570	A	S3-1	30	30		SCHOOL BUS STOP AHEAD																						
NB	0.585	C	VR-017	24	24																								
		C	VR-017	24	24			4.00 5.00										X								E-141			
NB	0.590	D	R1-1	24	24																								
		D	R1-1	30	30			6.25										X						X	INSTALL CLOSER TO ROUTE 14 IN ISLAND				
NB	0.595	D	R1-1	30	30			6.25										X						X	INSTALL AT NORMAL LOCATION				
NB	0.600	A	W11-2	30	30																								
		A	W11-2	30	30	FYG		6.25										X						X					
		A	W16-9	24	12	FYG		2.00																X					
NB	0.720	A	M3-1	24	12																								
SIGN SUMMARY SHEET							SHEET TOTALS	39.75 40.75	0.00	0	0	0	9 7	0	0	8	120												
VERMONT AGENCY OF TRANSPORTATION							TOWN TOTALS	99.8	0.0	0.0	0.0	0.0	20	0.0	0.0	17	255.0												
PROJECT NAME: Hartford-East Montpelier VT14																					SIGN DETAIL								
PROJECT NUMBER: STPG SIGN(21)																					SIGN DETAIL								
FILE NAME: Bethel.xls																		PLOT DATE: 6/10/2009											
PROJECT MANAGER: N. Avery																		DRAWN BY: T. Guazzoni											
DESIGNED BY: D. Crossley																		CHECKED BY: S. Menard											
BETHEL SHEET 1																		SHEET 61 OF 162											

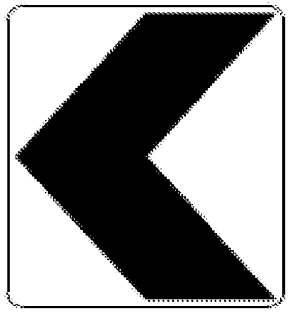
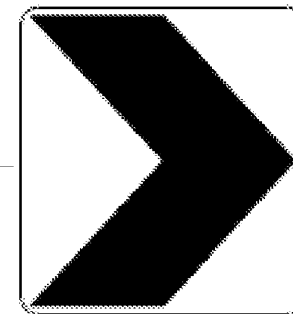
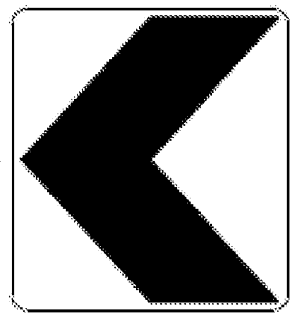
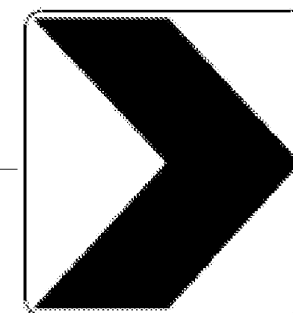

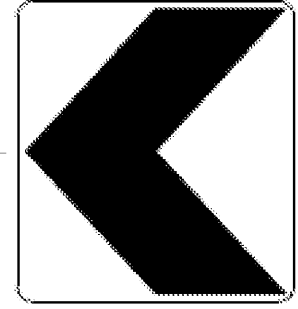
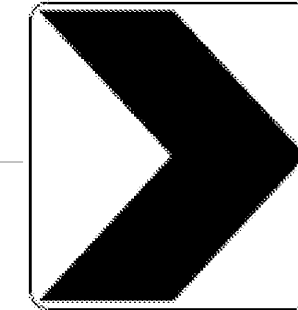
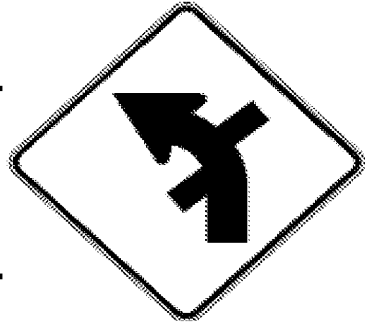

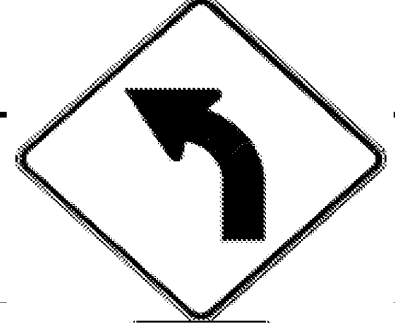

DIRECTION	MILEPOINT	LOCATION CODE (SHEET 2)	SIGN CODE	WIDTH (IN)	HEIGHT (IN)	SHEETING REMARKS	SIGN LEGEND	NEW SIGNS		EXISTING SIGNS				EXIST POST		NUMBER OF NEW POSTS	SQUARE STEEL (IN)			TUBULAR STEEL Ø (IN)				SIGN FRAME REQUIRED	REMARKS	SIGN DETAIL			
								"A"	"B"	RETAIN	SALVAGE FROM	SALVAGE TO	REMOVE	RETAIN	REMOVE		1.75	2.00	2.50	FOUNDATION	3.00	3.50	4.00			5.00	DETAIL IN SHS	DETAIL ON SHEET NUMBER	DETAIL ON STD SHEET NUMBER
																	(LB / FT)				(LB / FT)								
BETHEL VT 14							FY-FLUORESCENT YELLOW FYG-FLUORESCENT YELLOW GREEN															"SHS"-STANDARD HIGHWAY SIGNS							
			A M1-5A	24	24							1																	
			A M3-1	24	12			2.00							1		X						GREEN ON WHITE SHEETING	X					
			A M1-5A	24	24			4.00																	E-136B				
NB	0.838		A S3-1	30	30							1																	
			A S3-1	30	30			6.25							1		X							X					
SB	0.820		F VD-018	30	18							1																	
			F VD-018	30	18			3.75							1		X								E-128B				
SB	0.800		F S3-1	30	30		SCHOOL BUS STOP AHEAD					1																	
			F W11-2	30	30	FYG		6.25							1		X							X					
			F W16-9	24	12	FYG		2.00																X					
SB	0.760		F W2-1Mf	30	30		SIDE ROAD RIGHT					1																	
			F S3-1	30	30		SCHOOL BUS STOP AHEAD					1																	
			F W2-2Ma R	30	30			6.25							1		X								6				
SB	0.696		G VR-017	24	30							1					X						FACTORY HILL RD TH- 3						
			G VR-017	24	30			5.00																	E-141				
SIGN SUMMARY SHEET							SHEET TOTALS	35.50	0.00	0	0	0	7	0	0	5		75					PROJECT NAME: Hartford-East Montpelier VT14						
							SF SF			EA	EA	EA	EA	EA	EA	EA		FT				PROJECT NUMBER: STPG SIGN(21)							
VERMONT AGENCY OF TRANSPORTATION							TOWN TOTALS	99.8	0.0	0.0	0.0	0.0	20	0.0	0.0	17		255.0				FILE NAME: Bethel.xls	PLOT DATE: 6/10/2009						
																					PROJECT MANAGER: N. Avery	DRAWN BY: T. Guazzoni							
																					DESIGNED BY: D. Crosslev	CHECKED BY: S. Menard							
																					BETHEL SHEET 2	SHEET 62 OF 162							

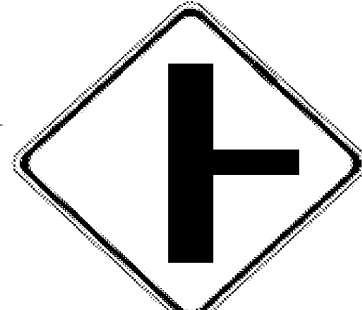

DIRECTION	MILEPOINT	LOCATION CODE (SHEET 2)	SIGN CODE	WIDTH (IN)	HEIGHT (IN)	SHEETING REMARKS	SIGN LEGEND	NEW SIGNS		EXISTING SIGNS				EXIST POST		NUMBER OF NEW POSTS	SQUARE STEEL (IN)			TUBULAR STEEL Ø (IN)				SIGN FRAME REQUIRED	REMARKS	SIGN DETAIL				
								"A"	"B"	RETAIN	SALVAGE FROM	SALVAGE TO	REMOVE	RETAIN	REMOVE		1.75	2.00	2.50	FOUNDATION	3.00	3.50	4.00			5.00	DETAIL IN SHS	DETAIL ON SHEET NUMBER	DETAIL ON STD SHEET NUMBER	
																	(LB / FT)				(LB / FT)									
BETHEL VT 14							FY-FLUORESCENT YELLOW FYG-FLUORESCENT YELLOW GREEN															"SHS"-STANDARD HIGHWAY SIGNS								
SB	0.688	H	R1-1	24	24																		FACTORY HILL RD TH- 3							
		H	R1-1	30	30			6.25																X						
SB	0.680	F	M3-3	24	12																		GREEN ON WHITE SHEETING							
		F	M1-5	24	24																									
		F	M3-3	24	12			2.00																X						
		F	M1-5	24	24			4.00																		E-136B				
SB	0.630	F	R2-1	24	30																	SPEED LIMIT 50								
		F	R2-1	24	30			5.00															X							
SB	0.395	F	VW-133L	30	30																	HIDDEN DRIVES LEFT								
		F	VW-133L	30	30			6.25															INSTALL 160' +/- SOUTH OF ORIGINAL SIGN LOCATION			E-154				
SB	0.000	G	VD-024	60	7.5																									
SIGN SUMMARY SHEET							SHEET TOTALS	23.50	0.00	0	0	0	6	0	0	4	60								PROJECT NAME: Hartford-East Montpelier VT14					
								SF	SF	EA	EA	EA	EA	EA	EA	EA	EA	EA	EA	FT							PROJECT NUMBER: STPG SIGN(21)			
							VERMONT AGENCY OF TRANSPORTATION	TOWN TOTALS	99.8	0.0	0.0	0.0	0.0	20	0.0	0.0	17	255.0									FILE NAME: Bethel.xls	PLOT DATE: 6/10/2009		
																					PROJECT MANAGER: N. Avery	DRAWN BY: T. Guazzoni								
																					DESIGNED BY: D. Crosslev	CHECKED BY: S. Menard								
																					BETHEL SHEET 3	SHEET 63 OF 162								





DIRECTION	MILEPOINT	LOCATION CODE (SHEET 2)	SIGN CODE	WIDTH (IN)	HEIGHT (IN)	SHEETING REMARKS	SIGN LEGEND FOR ALL POST LENGTHS AND INSTALLATION DATES SEE ORIGINAL RECORD PLANS	NEW SIGNS		EXISTING SIGNS				EXIST POST		NUMBER OF NEW POSTS	SQUARE STEEL (IN) (LB / FT)			TUBULAR STEEL Ø (IN) (LB / FT)				SIGN FRAME REQUIRED	REMARKS	SIGN DETAIL										
								"A"	"B"	RETAIN	SALVAGE FROM	SALVAGE TO	REMOVE	RETAIN	REMOVE		1.75	2.00	2.50	FOUNDATION	3.00	3.50	4.00			5.00	DETAIL IN SHS	DETAIL ON SHEET NUMBER	DETAIL ON STD SHEET NUMBER							
																	1.88	2.42	3.35		7.60	9.00	10.80			14.60										
RANDOLPH VT 14							FY-FLUORESCENT YELLOW FYG-FLUORESCENT YELLOW GREEN															"SHS"-STANDARD HIGHWAY SIGNS														
NB	0.000	C	VD-025	60	7.5																															
		C	VD-024	60	7.5																															
		C	VD-025	72	10			0.84																												4
		C	VD-024	72	10			5.00																												4
NB	0.075 0.750	C	VR-017	24	30																															
		C	VR-017	24	30			5.00																												E-141
NB	0.085	D	R1-1	30	30																															
		D	R1-1	30	30			6.25																												X
NB	0.130	A	R2-1	24	30			5.00																												X
NB	0.880	A	W5-2	30	30		NARROW BRIDGE 																													
NB	0.920	A	W5-2	30	30			6.25																												X
NB	0.990	B	OM-3L	12	36																															
		B	OM-3L	12	36			3.00																												X
NB	1.050	A	OM-3R	12	36																															
SIGN SUMMARY SHEET							SHEET TOTALS	36.34 35.50	0.00	0	0	0	8 7	0	0	7	105						PROJECT NAME: Hartford-East Montpelier VT14 PROJECT NUMBER: STPG SIGN(25)													
VERMONT AGENCY OF TRANSPORTATION							TOWN TOTALS	771.4	0.0	19.0	5.0	5.0	155	0.0	0.0	130	1950.0						FILE NAME: Randolph.xls PROJECT MANAGER: N. Avery DESIGNED BY: D. Crossley RANDOLPH SHEET 1													
																						PLOT DATE: 6/18/2009 DRAWN BY: I. Shea CHECKED BY: S. Menard SHEET 64 OF 162														

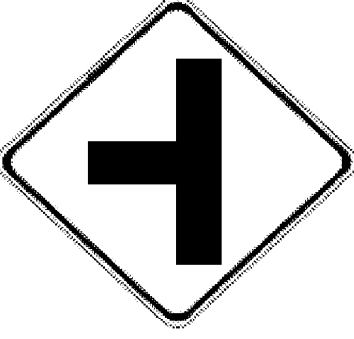



DIRECTION	MILEPOINT	LOCATION CODE (SHEET 2)	SIGN CODE	WIDTH (IN)	HEIGHT (IN)	SHEETING REMARKS	SIGN LEGEND FOR ALL POST LENGTHS AND INSTALLATION DATES SEE ORIGINAL RECORD PLANS	NEW SIGNS		EXISTING SIGNS				EXIST POST		NUMBER OF NEW POSTS	SQUARE STEEL (IN)			TUBULAR STEEL Ø (IN)				SIGN FRAME REQUIRED	REMARKS	SIGN DETAIL			
								"A"	"B"	RETAIN	SALVAGE FROM	SALVAGE TO	REMOVE	RETAIN	REMOVE		1.75	2.00	2.50	FOUNDATION	3.00	3.50	4.00			5.00	DETAIL IN SHS	DETAIL ON SHEET NUMBER	DETAIL ON STD SHEET NUMBER
																	(LB / FT)				(LB / FT)								
RANDOLPH VT 14							FY-FLUORESCENT YELLOW FYG-FLUORESCENT YELLOW GREEN															"SHS"-STANDARD HIGHWAY SIGNS							
			A OM-3R	12	36			3.00							1	X								X					
NB	1.280		A VD-018	30	18																								
			A VD-018	30	18			3.75							1	X									E-128B				
NB	1.390		A W1-2L	30	30		LEFT CURVE																						
			A W13-1	18	18		35 MPH PLAQUE																						
NB	1.450		A W1-2L	30	30			6.25							1	X								X	INSTALL 300' +/- NORTH OF ORIGINAL SIGN LOCATION				
			A W13-1	18	18			2.25																X					
NB	1.480		A W1-8L	18	24																								
			A W1-8L	24	30			5.00							1	X							X						
NB	1.480		B W1-8R	18	24																								
			B W1-8R	24	30			5.00							1	X							X						
NB	1.490		A W1-8L	18	24																								
			A W1-8L	24	30			5.00							1	X							X						
NB	1.490		B W1-8R	18	24																								
			B W1-8R	24	30			5.00							1	X							X						
SIGN SUMMARY SHEET							SHEET TOTALS	35.25	0.00	0	0	0	8 7	0	0	7	105												
VERMONT AGENCY OF TRANSPORTATION								SF	SF	EA	EA	EA	EA	EA	EA	EA	FT												
							TOWN TOTALS	771.4	0.0	19.0	5.0	5.0	155	0.0	0.0	130	1950.0												
															PROJECT NAME: Hartford-East Montpelier VT14														
															PROJECT NUMBER: STPG SIGN(25)														
															FILE NAME: Randolph.xls					PLOT DATE: 6/18/2009									
															PROJECT MANAGER: N. Avery					DRAWN BY: I. Shea									
															DESIGNED BY: D. Crossley					CHECKED BY: S. Menard									
															RANDOLPH SHEET 2					SHEET 65 OF 162									

DIRECTION	MILEPOINT	LOCATION CODE (SHEET 2)	SIGN CODE	WIDTH (IN)	HEIGHT (IN)	SHEETING REMARKS	SIGN LEGEND	NEW SIGNS		EXISTING SIGNS				EXIST POST		NUMBER OF NEW POSTS	SQUARE STEEL (IN)			TUBULAR STEEL Ø (IN)				SIGN FRAME REQUIRED	REMARKS	SIGN DETAIL		
								"A"	"B"	RETAIN	SALVAGE FROM	SALVAGE TO	REMOVE	RETAIN	REMOVE		1.75	2.00	2.50	3.00	3.50	4.00	5.00			DETAIL IN SHS	DETAIL ON SHEET NUMBER	DETAIL ON STD SHEET NUMBER
																	(LB / FT)			(LB / FT)								
RANDOLPH VT 14							FY-FLUORESCENT YELLOW FYG-FLUORESCENT YELLOW GREEN															"SHS"-STANDARD HIGHWAY SIGNS						
NB	1.495	A	W1-8L	18	24																							
		A	W1-8L	24	30			5.00																X				
NB	1.495	B	W1-8R	18	24																							
		B	W1-8R	24	30			5.00																X				
NB	1.920	A	W2-1Mg	30	30		LEFT CURVE MODIFIED																					
																												
NB	2.030	A	W1-2Mk L	30	30			6.25																	6			
																												
NB	2.129	C	VR-017	24	24																							
		C	VR-017	24	30			5.00																	E-141			
NB	2.137	D	R1-1	24	24																							
		D	R1-1	30	30			6.25																X				
NB	2.560	A	W1-2 L	30	30		LEFT CURVE																					
		A	W13-1	18	18		40 MPH PLAQUE																					
																												
NB	2.630	A	W1-2 L	30	30			6.25																X				
		A	W13-1	18	18			2.25																X				
NB	2.660	A	W1-6L	48	24			8.00																X				
SIGN SUMMARY SHEET							SHEET TOTALS	44.00	0.00	0	0	0	7	0	0	8	120							PROJECT NAME: Hartford-East Montpelier VT14				
								SF	SF	EA	EA	EA	EA	EA	EA	EA	FT							PROJECT NUMBER: STPG SIGN(25)				
VERMONT AGENCY OF TRANSPORTATION							TOWN TOTALS	771.4	0.0	19.0	5.0	5.0	155	0.0	0.0	130	1950.0							FILE NAME: Randolph.xls				
																								PLOT DATE: 6/18/2009				
																								DRAWN BY: I. Shea				
																								DESIGNED BY: D. Crosslev				
																								CHECKED BY: S. Menard				
																								SHEET 66 OF 162				

DIRECTION	MILEPOINT	LOCATION CODE (SHEET 2)	SIGN CODE	WIDTH (IN)	HEIGHT (IN)	SHEETING REMARKS	SIGN LEGEND	NEW SIGNS		EXISTING SIGNS				EXIST POST		NUMBER OF NEW POSTS	SQUARE STEEL (IN)			TUBULAR STEEL Ø (IN)				SIGN FRAME REQUIRED	REMARKS	SIGN DETAIL			
								"A"	"B"	RETAIN	SALVAGE FROM	SALVAGE TO	REMOVE	RETAIN	REMOVE		1.75	2.00	2.50	FOUNDATION	3.00	3.50	4.00			5.00	DETAIL IN SHS	DETAIL ON SHEET NUMBER	DETAIL ON STD SHEET NUMBER
																	(LB / FT)				(LB / FT)								
RANDOLPH VT 14							FY-FLUORESCENT YELLOW FYG-FLUORESCENT YELLOW GREEN															"SHS"-STANDARD HIGHWAY SIGNS							
NB	2.670	B	W1-6L	48	24			8.00							2		X								INSTALL 50'+/- NORTH OF PREVIOUS SIGN	X			
NB	3.140	A	W2-2Ma R	30	30							1																	
		A	W5-2	30	30							1																	
		A	W2-2Ma R	30	30			6.25							2												6		
		A	W5-2	30	30			6.25									X							X		X			
NB	3.254	C	VR-017	24	24							1																	
		C	VR-017	24	30				5.00							1		X											E-141
NB	3.255	D	R1-1	24	24							1																	
		D	R1-1	30	30			6.25							1		X									X			
NB	3.262	D	R1-1	24	24							1																	
		D	R1-1	30	30			6.25							1		X									X			
NB	3.270	A	OM-3R	12	36							1																	
		A	OM-3R	12	36			3.00							1		X									X			
NB	3.280	B	OM-3L	12	36							1																	
		B	OM-3L	12	36			3.00							1		X									X			
SIGN SUMMARY SHEET							SHEET TOTALS	44.00	0.00	0	0	0	7	0	0	9		135								PROJECT NAME: Hartford-East Montpelier VT14			
								SF	SF	EA	EA	EA	EA	EA	EA	EA		FT								PROJECT NUMBER: STPG SIGN(25)			
VERMONT AGENCY OF TRANSPORTATION							TOWN TOTALS	771.4	0.0	19.0	5.0	5.0	155	0.0	0.0	130		1950.0								FILE NAME: Randolph.xls			
																										PLOT DATE: 6/18/2009			
																										DRAWN BY: I. Shea			
																										DESIGNED BY: D. Crosslev			
																										CHECKED BY: S. Menard			
																										SHEET 67 OF 162			

DIRECTION	MILEPOINT	LOCATION CODE (SHEET 2)	SIGN CODE	WIDTH (IN)	HEIGHT (IN)	SHEETING REMARKS	SIGN LEGEND FOR ALL POST LENGTHS AND INSTALLATION DATES SEE ORIGINAL RECORD PLANS	NEW SIGNS		EXISTING SIGNS				EXIST POST		NUMBER OF NEW POSTS	SQUARE STEEL (IN)			TUBULAR STEEL Ø (IN)				SIGN FRAME REQUIRED	REMARKS	SIGN DETAIL									
								"A"	"B"	RETAIN	SALVAGE FROM	SALVAGE TO	REMOVE	RETAIN	REMOVE		1.75	2.00	2.50	FOUNDATION	3.00	3.50	4.00			5.00	DETAIL IN SHS	DETAIL ON SHEET NUMBER	DETAIL ON STD SHEET NUMBER						
																	(LB / FT)				(LB / FT)														
RANDOLPH VT 14							FY-FLUORESCENT YELLOW FYG-FLUORESCENT YELLOW GREEN																"SHS"-STANDARD HIGHWAY SIGNS												
NB	3.320	A	W1-4R	30	30		RIGHT REVERSE CURVE																												
NB	3.440	A	VW-060	30	30		HIDDEN DRIVES																												
NB	3.460	A	W11-5	30	30		FARM MACHINERY SYMBOL																												
		A	W7-3A	24	18		NEXT 1 MILE																												
NB	3.482	A	W11-5	30	30		FARM MACHINERY SYMBOL																												
		A	W7-3A	24	18		NEXT 1 MILE																												
NB	3.500	A	VW-060	30	30		HIDDEN DRIVES																												
NB	3.600	A	W2-2L	30	30																														
		A	W2-2L	30	30																														
NB	3.775	A	W1-4R	30	30		RIGHT REVERSE CURVE																												
NB	3.974	A	W3-5	36	36		SPEED REDUCTION 40 MPH																												
NB	4.055	A	R2-1	24	30																														
		A	R2-1	30	36																														
NB	4.190	A	VD-018	30	18																														
		A	VD-018	30	18																														
SIGN SUMMARY SHEET							SHEET TOTALS	33.00 23.75	0.00	2	0	0	5	0	0	5	75																		
VERMONT AGENCY OF TRANSPORTATION							TOWN TOTALS	771.4	0.0	19.0	5.0	5.0	155	0.0	0.0	130	1950.0																		
PROJECT NAME: Hartford-East Montpelier VT14																					PROJECT NUMBER: STPG SIGN(25)					FILE NAME: Randolph.xls					PLOT DATE: 6/18/2009				
PROJECT MANAGER: N. Avery																					DRAWN BY: I. Shea					DESIGNED BY: D. Crossley					CHECKED BY: S. Menard				
RANDOLPH SHEET 5																					SHEET 68					OF 162									

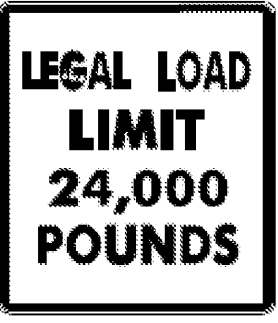

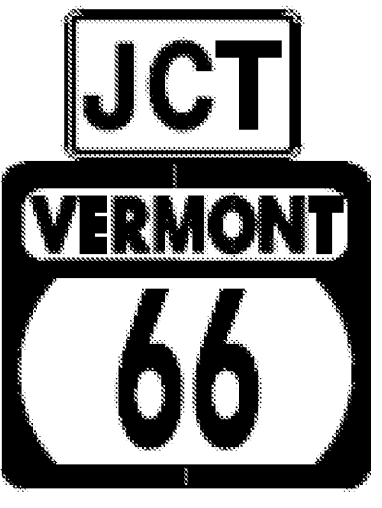



DIRECTION	MILEPOINT	LOCATION CODE (SHEET 2)	SIGN CODE	WIDTH (IN)	HEIGHT (IN)	SHEETING REMARKS	SIGN LEGEND FOR ALL POST LENGTHS AND INSTALLATION DATES SEE ORIGINAL RECORD PLANS	NEW SIGNS		EXISTING SIGNS				EXIST POST		NUMBER OF NEW POSTS	SQUARE STEEL (IN) (LB / FT)			TUBULAR STEEL Ø (IN) (LB / FT)				SIGN FRAME REQUIRED	REMARKS	SIGN DETAIL			
								"A"	"B"	RETAIN	SALVAGE FROM	SALVAGE TO	REMOVE	RETAIN	REMOVE		1.75	2.00	2.50	FOUNDATION	3.00	3.50	4.00			5.00	DETAIL IN SHS	DETAIL ON SHEET NUMBER	DETAIL ON STD SHEET NUMBER
																	1.88	2.42	3.35		7.60	9.00	10.80			14.60			
RANDOLPH VT 14							FY-FLUORESCENT YELLOW FYG-FLUORESCENT YELLOW GREEN															"SHS"-STANDARD HIGHWAY SIGNS							
NB	4.242	A	S1-1YG	30	30		SCHOOL SYMBOL			1																			
		A	W16-9YG	24	12		AHEAD			1																			
NB	4.277	A	R2-1	30	36		SPEED LIMIT 35			1																			
NB	4.310	A	W11-6H	30	30							1																	
		A	W11-6H	30	30			6.25							1			X									E-153		
NB	4.405	A	W2-2MR	30	30		MODIFIED RIGHT SIDE ROAD			1																			
		A	W16-8A	24	18		TUNBRIDGE ROAD			1																			
NB	4.460	A	W5-2	30	30																								
		A	W5-2	30	30			6.25							1			X								X			
NB	4.490	C	VR-017	24	24																								
		C	VR-017	24	30			5.00							1			X									E-141		
NB	4.495	D	R1-1	24	24																								
		D	R1-1	30	30			6.25							1			X								X			
NB	4.500	D	R1-1	24	24							1																	
		D	R1-1	30	30			6.25							1			X								X			
SIGN SUMMARY SHEET							SHEET TOTALS		30.00	0.00	5	0	0	5	0	0	5	75							PROJECT NAME: Hartford-East Montpelier VT14				
VERMONT AGENCY OF TRANSPORTATION							TOWN TOTALS		SF	SF	EA	EA	EA	EA	EA	EA	EA	FT							PROJECT NUMBER: STPG SIGN(25)				
									771.4	0.0	19.0	5.0	5.0	155	0.0	0.0	130	1950.0						FILE NAME: Randolph.xls					
																								PLOT DATE: 6/18/2009					
																								DRAWN BY: I. Shea					
																								DESIGNED BY: D. Crossley					
																								CHECKED BY: S. Menard					
																								SHEET 69 OF 162					







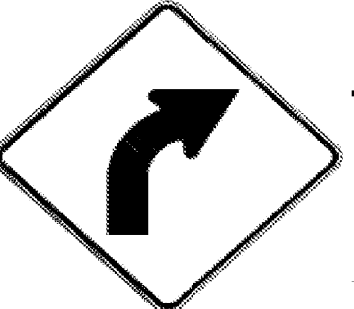



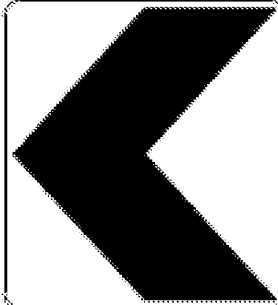

DIRECTION	MILEPOINT	LOCATION CODE (SHEET 2)	SIGN CODE	WIDTH (IN)	HEIGHT (IN)	SHEETING REMARKS	SIGN LEGEND	NEW SIGNS		EXISTING SIGNS				EXIST POST		NUMBER OF NEW POSTS	SQUARE STEEL (IN)			TUBULAR STEEL Ø (IN)				SIGN FRAME REQUIRED	REMARKS	SIGN DETAIL			
								"A"	"B"	RETAIN	SALVAGE FROM	SALVAGE TO	REMOVE	RETAIN	REMOVE		1.75	2.00	2.50	FOUNDATION	3.00	3.50	4.00			5.00	DETAIL IN SHS	DETAIL ON SHEET NUMBER	DETAIL ON STD SHEET NUMBER
																	(LB / FT)				(LB / FT)								
RANDOLPH VT 14							FY-FLUORESCENT YELLOW FYG-FLUORESCENT YELLOW GREEN															"SHS"-STANDARD HIGHWAY SIGNS							
NB	4.573	A	D1-1A	72	12			6.00								2	X									5			
		A	D1-1A	72	12			6.00																		5			
NB	4.666	C	VR-017	24	24																								
		C	VR-017	24	30			5.00								1	X									E-141			
NB	4.674	D	R1-1	24	24																								
		D	R1-1	30	30			6.25								1	X							X					
NB	4.690	A	M3-1	24	12																								
		A	M3-1	24	24																								
		A	M3-1	24	12			2.00								1	X												
		A	M3-1	24	24			4.00																					
NB	4.750	A	R2-1	24	30		SPEED LIMIT 35																						
																1													
NB	4.820	A	M2-1	21	15			2.19																					
		A	M1-5	24	24			4.00									X							X		E-136B			
NB	4.860	A	M2-1	21	15		JCT																						
		A	M1-5	24	24		VERMONT 66																						
SIGN SUMMARY SHEET							SHEET TOTALS	35.44	0.00	1	0	0	6	0	0	6	90					PROJECT NAME: Hartford-East Montpelier VT14							
							SF	SF	EA	EA	EA	EA	EA	EA	EA	EA	FT					PROJECT NUMBER: STPG SIGN(25)							
VERMONT AGENCY OF TRANSPORTATION							TOWN TOTALS	771.4	0.0	19.0	5.0	5.0	155	0.0	0.0	130	1950.0					FILE NAME: Randolph.xls	PLOT DATE: 6/18/2009						
																					PROJECT MANAGER: N. Avery	DRAWN BY: I. Shea							
																					DESIGNED BY: D. Crosslev	CHECKED BY: S. Menard							
																					RANDOLPH SHEET 7	SHEET 70 OF 162							







DIRECTION	MILEPOINT	LOCATION CODE (SHEET 2)	SIGN CODE	WIDTH (IN)	HEIGHT (IN)	SHEETING REMARKS	SIGN LEGEND	NEW SIGNS		EXISTING SIGNS				EXIST POST		NUMBER OF NEW POSTS	SQUARE STEEL (IN)			TUBULAR STEEL Ø (IN)				SIGN FRAME REQUIRED	REMARKS	SIGN DETAIL			
								"A"	"B"	RETAIN	SALVAGE FROM	SALVAGE TO	REMOVE	RETAIN	REMOVE		1.75	2.00	2.50	FOUNDATION	3.00	3.50	4.00			5.00	DETAIL IN SHS	DETAIL ON SHEET NUMBER	DETAIL ON STD SHEET NUMBER
																	(LB / FT)				(LB / FT)								
RANDOLPH VT 14							FY-FLUORESCENT YELLOW FYG-FLUORESCENT YELLOW GREEN															"SHS"-STANDARD HIGHWAY SIGNS							
NB	4.890	A	D1-1A	72	10																								
		A	D1-1A	72	10																								
		A	D1-1A	72	10																								
		A	D1-1A	72	10																								
		A	D1-1A	72	12			6.00						2			X									5			
		A	D1-1A	72	12			6.00																			5		
		A	D1-1A	72	12			6.00																			5		
		A	D1-1A	72	12			6.00																			5		
NB	4.920	A	M3-4	24	12																								
		A	M1-5	24	24																								
		A	M6-1 L	21	15																								
		A	M4-5	24	12																								
		A	M1-1	24	24																								
		A	M6-1 L	21	15																								
		A	M3-1	24	12																								
SIGN SUMMARY SHEET							SHEET TOTALS	24.00	0.00	0	0	0	11	0	0	2	30							PROJECT NAME: Hartford-East Montpelier VT14					
								SF	SF	EA	EA	EA	EA	EA	EA	EA	FT							PROJECT NUMBER: STPG SIGN(25)					
VERMONT AGENCY OF TRANSPORTATION							TOWN TOTALS	771.4	0.0	19.0	5.0	5.0	155	0.0	0.0	130	1950.0							FILE NAME: Randolph.xls	PLOT DATE: 6/18/2009				
																								PROJECT MANAGER: N. Avery	DRAWN BY: I. Shea				
																								DESIGNED BY: D. Crosslev	CHECKED BY: S. Menard				
																								RANDOLPH SHEET 8	SHEET 71 OF 162				







DIRECTION	MILEPOINT	LOCATION CODE (SHEET 2)	SIGN CODE	WIDTH (IN)	HEIGHT (IN)	SHEETING REMARKS	SIGN LEGEND	NEW SIGNS		EXISTING SIGNS				EXIST POST		NUMBER OF NEW POSTS	SQUARE STEEL (IN)			TUBULAR STEEL Ø (IN)				SIGN FRAME REQUIRED	REMARKS	SIGN DETAIL		
								"A"	"B"	RETAIN	SALVAGE FROM	SALVAGE TO	REMOVE	RETAIN	REMOVE		1.75	2.00	2.50	FOUNDATION						DETAIL IN SHS	DETAIL ON SHEET NUMBER	DETAIL ON STD SHEET NUMBER
																	(LB / FT)			3.00	3.50	4.00	5.00					
RANDOLPH VT 14							FY-FLUORESCENT YELLOW FYG-FLUORESCENT YELLOW GREEN															"SHS"-STANDARD HIGHWAY SIGNS						
			A M1-5	24	24						1																	
			A M6-3	21	15							1																
			A M3-4	24	12				2.00													3A	GREEN ON WHITE SHEETING	X	7			
			A M1-5	24	24				4.00																E-136B			
			A M6-1 L	21	15				2.19															X				
			A M4-5	24	12				2.00															X				
			A M1-1	24	24				4.00															X				
			A M6-1 L	21	15				2.19															X				
			A M3-1	24	12				2.00															X				
			A M1-5	24	24				4.00																E-136B			
			A M6-3	21	15			2.19															X					
NB	4.925		C M3-1	24	12							1	X															
			C M1-5	24	24																							
			C M6-1 L	21	15																							
			C M3-3	24	12																							
SIGN SUMMARY SHEET							SHEET TOTALS	24.57	0.00	0	0	0	6	0	0	0		0						PROJECT NAME: Hartford-East Montpelier VT14 PROJECT NUMBER: STPG SIGN(25)				
VERMONT AGENCY OF TRANSPORTATION							TOWN TOTALS	771.4	0.0	19.0	5.0	5.0	155	0.0	0.0	130		1950.0					FILE NAME: Randolph.xls PROJECT MANAGER: N. Avery DESIGNED BY: D. Crosslev RANDOLPH SHEET 9	PLOT DATE: 6/18/2009 DRAWN BY: I. Shea CHECKED BY: S. Menard SHEET 72 OF 162				



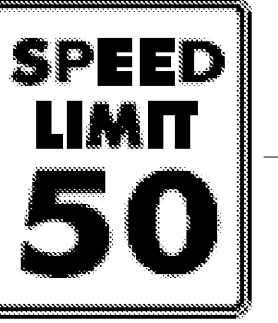

DIRECTION	MILEPOINT	LOCATION CODE (SHEET 2)	SIGN CODE	WIDTH (IN)	HEIGHT (IN)	SHEETING REMARKS	SIGN LEGEND FOR ALL POST LENGTHS AND INSTALLATION DATES SEE ORIGINAL RECORD PLANS	NEW SIGNS		EXISTING SIGNS				EXIST POST		NUMBER OF NEW POSTS	SQUARE STEEL (IN) (LB / FT)			TUBULAR STEEL Ø (IN) (LB / FT)				SIGN FRAME REQUIRED	REMARKS	SIGN DETAIL			
								"A"	"B"	RETAIN	SALVAGE FROM	SALVAGE TO	REMOVE	RETAIN	REMOVE		1.75	2.00	2.50	FOUNDATION	3.00	3.50	4.00			5.00	DETAIL IN SHS	DETAIL ON SHEET NUMBER	DETAIL ON STD SHEET NUMBER
RANDOLPH VT 14							FY-FLUORESCENT YELLOW FYG-FLUORESCENT YELLOW GREEN															"SHS"-STANDARD HIGHWAY SIGNS							
		C	M1-5	24	24																								
		C	M6-1 R	21	15																								
		C	M3-1	24	12			2.00														#2	GREEN ON WHITE SHEETING	X	7				
		C	M1-5	24	24			4.00																	E-136B				
		C	M6-1 L	21	15			2.19															GREEN ON WHITE SHEETING	X					
		C	M3-3	24	12			2.00															GREEN ON WHITE SHEETING	X					
		C	M1-5	24	24			4.00																	E-136B				
		C	M6-1 R	21	15			2.19															GREEN ON WHITE SHEETING	X					
NB	4.970	A	M3-1	24	12																								
		A	M1-5	24	24																								
		A	M3-1	24	12			2.00															GREEN ON WHITE SHEETING	X					
		A	M1-5	24	24			4.00																	E-136B				
NB	5.007	A	R2-1	24	30																	SPEED LIMIT 35 MPH							
NB	5.166	A	R2-1	24	30																	SPEED LIMIT 35 MPH							
NB	5.295	A	W5-2	30	30																	NARROW BRIDGE							
SIGN SUMMARY SHEET							SHEET TOTALS	22.38	0.00	2	0	0	5	0	0	3	0						PROJECT NAME: Hartford-East Montpelier VT14 PROJECT NUMBER: STPG SIGN(25)						
VERMONT AGENCY OF TRANSPORTATION							TOWN TOTALS	771.4	0.0	19.0	5.0	5.0	155	0.0	0.0	130	1950.0					FILE NAME: Randolph.xls PLOT DATE: 6/18/2009 PROJECT MANAGER: N. Avery DRAWN BY: I. Shea DESIGNED BY: D. Crossley CHECKED BY: S. Menard RANDOLPH SHEET 10 SHEET 73 OF 162							

DIRECTION	MILEPOINT	LOCATION CODE (SHEET 2)	SIGN CODE	WIDTH (IN)	HEIGHT (IN)	SHEETING REMARKS	SIGN LEGEND FOR ALL POST LENGTHS AND INSTALLATION DATES SEE ORIGINAL RECORD PLANS	NEW SIGNS		EXISTING SIGNS				EXIST POST		NUMBER OF NEW POSTS	SQUARE STEEL (IN) (LB / FT)			TUBULAR STEEL Ø (IN) (LB / FT)				SIGN FRAME REQUIRED	REMARKS	SIGN DETAIL			
								"A"	"B"	RETAIN	SALVAGE FROM	SALVAGE TO	REMOVE	RETAIN	REMOVE		1.75	2.00	2.50	FOUNDATION	3.00	3.50	4.00			5.00	DETAIL IN SHS	DETAIL ON SHEET NUMBER	DETAIL ON STD SHEET NUMBER
RANDOLPH VT 14							FY-FLUORESCENT YELLOW FYG-FLUORESCENT YELLOW GREEN																"SHS"-STANDARD HIGHWAY SIGNS						
NB	5.346	A	R2-1	24	30		SPEED LIMIT 50 MPH			1																			
NB	5.380	A	W5-2	30	30			6.25							1	X									INSTALL 150'+/- NORTH OF SPEED LIMIT 50	X			
NB	5.415	A	OM-3R	12	36		RIGHT OBJECT MARKER				1						X												
NB	5.410	A	OM-3R	12	36		RIGHT OBJECT MARKER					1						X											
NB	5.420	B	OM-3L	12	36		LEFT OBJECT MARKER				1	1					X												
NB	5.900	A	W11-6	30	30		SNOWMOBILE SYMBOL						1				X												
NB	6.290	A	W5-2	30	30			6.25							1			X							INSTALL 150' NORTH OF DRIVEWAY #1334	X			
NB	6.365	A	OM-3R	12	36								1				X												
		A	OM-3R	12	36			3.00							1			X							X				
NB	6.385	B	OM-3L	12	36			3.00						1				X							INSTALL AT NORTH END OF BRIDGE 38	X			
NB	6.670	A	W1-2R	30	30		RIGHT CURVE						1				X												
		A	W13-1	18	18		35 MPH PLAQUE						1																
NB	6.690	A	W1-2R	30	30			6.25							1			X							INSTALL 130' +/- NORTH OF ORIGINAL SIGN LOCATION	X			
		A	W13-1	18	18			2.25																	X				
NB	6.698	C	VR-017	24	24																								
SIGN SUMMARY SHEET							SHEET TOTALS		27.00	0.00	1	2	2	5	0	0	7	105							PROJECT NAME: Hartford-East Montpelier VT14				
VERMONT AGENCY OF TRANSPORTATION									SF	SF	EA	EA	EA	EA	EA	EA	EA	FT							PROJECT NUMBER: STPG SIGN(25)				
							TOWN TOTALS		771.4	0.0	19.0	5.0	5.0	155	0.0	0.0	130	1950.0							FILE NAME: Randolph.xls	PLOT DATE: 6/18/2009			
																									PROJECT MANAGER: N. Avery	DRAWN BY: I. Shea			
																									DESIGNED BY: D. Crosslev	CHECKED BY: S. Menard			
																									RANDOLPH SHEET 11	SHEET 74 OF 162			

DIRECTION	MILEPOINT	LOCATION CODE (SHEET 2)	SIGN CODE	WIDTH (IN)	HEIGHT (IN)	SHEETING REMARKS	SIGN LEGEND	NEW SIGNS		EXISTING SIGNS				EXIST POST		NUMBER OF NEW POSTS	SQUARE STEEL (IN)			TUBULAR STEEL Ø (IN)				SIGN FRAME REQUIRED	REMARKS	SIGN DETAIL			
								"A"	"B"	RETAIN	SALVAGE FROM	SALVAGE TO	REMOVE	RETAIN	REMOVE		1.75	2.00	2.50	FOUNDATION	3.00	3.50	4.00			5.00	DETAIL IN SHS	DETAIL ON SHEET NUMBER	DETAIL ON STD SHEET NUMBER
																	(LB / FT)				(LB / FT)								
RANDOLPH VT 14							FY-FLUORESCENT YELLOW FYG-FLUORESCENT YELLOW GREEN																"SHS"-STANDARD HIGHWAY SIGNS						
		C	VR-017	24	30			5.00							1	X												E-141	
NB	6.706	D	R1-1	24	24									1		X													
		D	R1-1	30	30			6.25							1		X								X				
NB	6.960	A	W1-8L	24	30			5.00							1		X								X			INSTALL AT CURVE APEX - FIRST CURVE PAST BRIDGE	
NB	6.961	B	W1-8R	24	30			5.00							1		X								X			INSTALL AT CURVE APEX - FIRST CURVE PAST BRIDGE	
NB	7.108	A	W5-2	30	30		NARROW BRIDGE							1		X													
		A	S3-1	30	30		SCHOOL BUS STOP AHEAD							1															
		A	W3-5	36	36			9.00							2		X								X				
NB	7.160	A	R2-5A	24	30		REDUCED SPEED AHEAD							1		X													
		A	W5-2	30	30			6.25							2		X								X				
		A	S3-1	30	30			6.25																	X				
NB	7.200	A	VD-018	30	18									1		X													
		A	VD-018	30	18			3.75							1		X											E-128B	
NB	7.230	A	R2-1	24	30									1		X													
		A	R2-1	30	36			7.50							1		X										6		
SIGN SUMMARY SHEET							SHEET TOTALS	54.00	0.00	0	0	0	6	0	0	10	150								PROJECT NAME: Hartford-East Montpelier VT14 PROJECT NUMBER: STPG SIGN(25)				
VERMONT AGENCY OF TRANSPORTATION							TOWN TOTALS	771.4	0.0	19.0	5.0	5.0	155	0.0	0.0	130	1950.0								FILE NAME: Randolph.xls PROJECT MANAGER: N. Avery DESIGNED BY: D. Crosslev RANDOLPH SHEET 12				
																								PLOT DATE: 6/18/2009 DRAWN BY: I. Shea CHECKED BY: S. Menard SHEET 75 OF 162					

DIRECTION	MILEPOINT	LOCATION CODE (SHEET 2)	SIGN CODE	WIDTH (IN)	HEIGHT (IN)	SHEETING REMARKS	SIGN LEGEND	NEW SIGNS		EXISTING SIGNS				EXIST POST		NUMBER OF NEW POSTS	SQUARE STEEL (IN)			TUBULAR STEEL Ø (IN)				SIGN FRAME REQUIRED	REMARKS	SIGN DETAIL						
								"A"	"B"	RETAIN	SALVAGE FROM	SALVAGE TO	REMOVE	RETAIN	REMOVE		1.75	2.00	2.50	FOUNDATION	3.00	3.50	4.00			5.00	DETAIL IN SHS	DETAIL ON SHEET NUMBER	DETAIL ON STD SHEET NUMBER			
																	(LB / FT)				(LB / FT)											
RANDOLPH VT 14							FY-FLUORESCENT YELLOW FYG-FLUORESCENT YELLOW GREEN															"SHS"-STANDARD HIGHWAY SIGNS										
NB	7.245	A	OM-3R	12	36																											
		A	OM-3R	12	36	FY		3.00												X					X							
NB	7.255	B	OM-3L	12	36																											
		B	OM-3L	12	36	FY		3.00												X					X							
NB	7.558	A	VS3-4	30	30																											
		A	VS3-4	30	30			6.25												X								5				
NB	7.600	A	R2-1	24	30																											
		A	R2-1	24	30			5.00												X					X							
SB	7.690	F	R2-5A	24	30		REDUCED SPEED AHEAD																									
		F	W3-5	36	36																											
		F	W3-5	36	36			9.00												X					X							
SB	7.640	F	VD-018	30	18																											
		F	VD-018	30	18			3.75												X					X				E-128B			
SB	7.620	F	R2-1	24	30																											
		F	R2-1	30	36			7.50												X					X			6				
SB	7.380	F	W5-2	30	30		NARROW BRIDGE																									
		F	W5-2	30	30																											
SIGN SUMMARY SHEET							SHEET TOTALS	37.50	0.00	0	0	0	8	0	0	8	120															
							SF	SF	EA	EA	EA	EA	EA	EA	EA	EA	FT															
VERMONT AGENCY OF TRANSPORTATION							TOWN TOTALS	771.4	0.0	19.0	5.0	5.0	155	0.0	0.0	130	1950.0															
												PROJECT NAME: Hartford-East Montpelier VT14										PROJECT NUMBER: STPG SIGN(25)										
												FILE NAME: Randolph.xls										PLOT DATE: 6/18/2009										
												PROJECT MANAGER: N. Avery										DRAWN BY: I. Shea										
												DESIGNED BY: D. Crosslev										CHECKED BY: S. Menard										
												RANDOLPH SHEET 13										SHEET 76 OF 162										





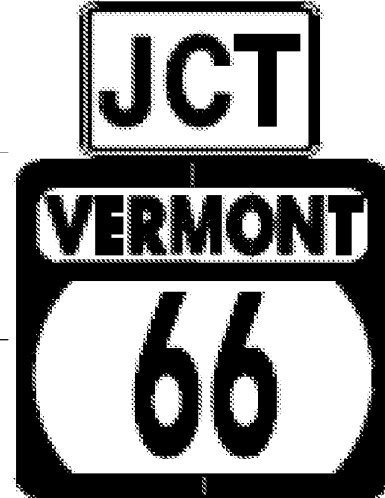
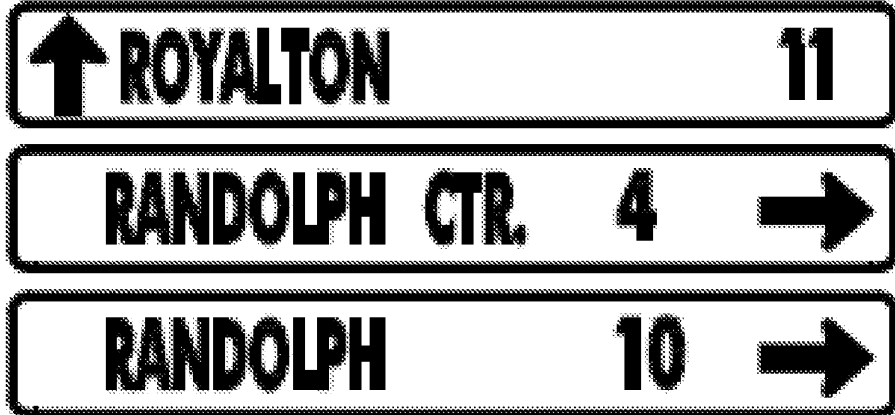

DIRECTION	MILEPOINT	LOCATION CODE (SHEET 2)	SIGN CODE	WIDTH (IN)	HEIGHT (IN)	SHEETING REMARKS	SIGN LEGEND	NEW SIGNS		EXISTING SIGNS				EXIST POST		NUMBER OF NEW POSTS	SQUARE STEEL (IN)			TUBULAR STEEL Ø (IN)				SIGN FRAME REQUIRED	REMARKS	SIGN DETAIL			
								"A"	"B"	RETAIN	SALVAGE FROM	SALVAGE TO	REMOVE	RETAIN	REMOVE		1.75	2.00	2.50	FOUNDATION	3.00	3.50	4.00			5.00	DETAIL IN SHS	DETAIL ON SHEET NUMBER	DETAIL ON STD SHEET NUMBER
																	(LB / FT)				(LB / FT)								
RANDOLPH VT 14							FY-FLUORESCENT YELLOW FYG-FLUORESCENT YELLOW GREEN															"SHS"-STANDARD HIGHWAY SIGNS							
SB	7.332	G	VR-017	24	24																								
		G	VR-017	24	30			5.00											X						E-141				
SB	7.328	H	R1-1	30	30			6.25											X					X					
SB	7.324	H	R1-1	24	24																								
		H	R1-1	30	30			6.25											X					X					
SB	7.310	F	W5-2	30	30			6.25											X					X					
																													
SB	7.255	F	OM-3R	12	36			3.00											X					X					
		F	OM-3R	12	36																								
SB	7.245	E	OM-3L	12	36			3.00											X					X					
		E	OM-3L	12	36																								
SB	7.230	F	R2-1	24	30																								
		F	R2-1	24	30			5.00											X					X					
SB	6.490	F	W5-2	30	30		NARROW BRIDGE																						
		F	S3-1	30	30		SCHOOL BUS STOP AHEAD																						
		F	S3-1	30	30			6.25											X					X					
SIGN SUMMARY SHEET							SHEET TOTALS	41.00	0.00	0	0	0	7	0	0	8	120							PROJECT NAME: Hartford-East Montpelier VT14					
							SF	SF	EA	EA	EA	EA	EA	EA	EA	EA	FT							PROJECT NUMBER: STPG SIGN(25)					
VERMONT AGENCY OF TRANSPORTATION							TOWN TOTALS	771.4	0.0	19.0	5.0	5.0	155	0.0	0.0	130	1950.0							FILE NAME: Randolph.xls					
																								PLOT DATE: 6/18/2009					
																									DRAWN BY: I. Shea				
																									DESIGNED BY: D. Crosslev				
																										CHECKED BY: S. Menard			
																										SHEET 77 OF 162			





DIRECTION	MILEPOINT	LOCATION CODE (SHEET 2)	SIGN CODE	WIDTH (IN)	HEIGHT (IN)	SHEETING REMARKS	SIGN LEGEND	NEW SIGNS		EXISTING SIGNS				EXIST POST		NUMBER OF NEW POSTS	SQUARE STEEL (IN)			TUBULAR STEEL Ø (IN)				SIGN FRAME REQUIRED	REMARKS	SIGN DETAIL			
								"A"	"B"	RETAIN	SALVAGE FROM	SALVAGE TO	REMOVE	RETAIN	REMOVE		1.75	2.00	2.50	FOUNDATION	3.00	3.50	4.00			5.00	DETAIL IN SHS	DETAIL ON SHEET NUMBER	DETAIL ON STD SHEET NUMBER
																	(LB / FT)				(LB / FT)								
RANDOLPH VT 14							FY-FLUORESCENT YELLOW FYG-FLUORESCENT YELLOW GREEN															"SHS"-STANDARD HIGHWAY SIGNS							
SB	6.440	F	W5-2	30	30			6.25							1	X								INSTALL 250' +/- SOUTH OF ORIGINAL SIGN LOCATION	X				
SB	6.385	F	OM-3R	12	36																								
		F	OM-3R	12	36			3.00							1	X										X			
SB	6.365	E	OM-3L	12	36																								
		E	OM-3L	12	36			3.00							1	X										X			
SB	5.520	F	W5-2	30	30		NARROW BRIDGE 																						
SB	5.500	F	W5-2	30	30			6.25							1	X								INSTALL 100' +/- SOUTH OF ORIGINAL LOCATION	X				
SB	5.471	F	W3-5	36	36		SPEED LIMIT 35 AHEAD			1						X													
SB	5.420	F	OM-3R	12	36		RIGHT OBJECT MARKER			1						X													
SB	5.410	E	OM-3L	12	36		LEFT OBJECT MARKER			1						X													
SB	5.346	F	R2-1	30	36		SPEED LIMIT 35			1						X													
SB	5.312	F	VW-054	30	30		HIDDEN DRIVES RIGHT				1						X												
SB	5.282	F	VW-054	30	30		HIDDEN DRIVES RIGHT					1			1	X								INSTALL SIGN 150' +/- SOUTH OF ORIGINAL LOCATION					
SB	5.166	F	R2-1	24	30		SPEED LIMIT 35			1						X													
SB	5.000	F	M2-1	21	15												X												
SIGN SUMMARY SHEET							SHEET TOTALS	18.50	0.00	5	1	1	4	0	0	5	75							PROJECT NAME: Hartford-East Montpelier VT14					
								SF	SF	EA	EA	EA	EA	EA	EA	EA	FT						PROJECT NUMBER: STPG SIGN(25)						
VERMONT AGENCY OF TRANSPORTATION							TOWN TOTALS	771.4	0.0	19.0	5.0	5.0	155	0.0	0.0	130	1950.0							FILE NAME: Randolph.xls	PLOT DATE: 6/18/2009				
																							PROJECT MANAGER: N. Avery	DRAWN BY: I. Shea					
																							DESIGNED BY: D. Crosslev	CHECKED BY: S. Menard					
																							RANDOLPH SHEET 15	SHEET 78 OF 162					





DIRECTION	MILEPOINT	LOCATION CODE (SHEET 2)	SIGN CODE	WIDTH (IN)	HEIGHT (IN)	SHEETING REMARKS	SIGN LEGEND	NEW SIGNS		EXISTING SIGNS				EXIST POST		NUMBER OF NEW POSTS	SQUARE STEEL (IN)			TUBULAR STEEL Ø (IN)				SIGN FRAME REQUIRED	REMARKS	SIGN DETAIL			
								"A"	"B"	RETAIN	SALVAGE FROM	SALVAGE TO	REMOVE	RETAIN	REMOVE		1.75	2.00	2.50	FOUNDATION	3.00	3.50	4.00			5.00	DETAIL IN SHS	DETAIL ON SHEET NUMBER	DETAIL ON STD SHEET NUMBER
																	(LB / FT)				(LB / FT)								
RANDOLPH VT 14							FY-FLUORESCENT YELLOW FYG-FLUORESCENT YELLOW GREEN															"SHS"-STANDARD HIGHWAY SIGNS							
			F M1-5	24	24																								
			F M2-1	21	15			2.19								1				X					GREEN ON WHITE SHEETING	X			
			F M1-5	24	24			4.00																				E-136B	
SB	4.970		F D1-1A	72	10																								
			F D1-1A	72	10																								
			F D1-1A	72	10																								
			F D1-1A	72	12			6.00							2				X									5	
			F D1-1A	72	12			6.00																				5	
			F D1-1A	72	12			6.00																				5	
SB	4.930		F M3-3	24	12																								
			F M1-5	24	24																								
			F M6-3	21	15																								
			F M3-4	24	12																								
			F M1-5	24	24																								
			F M6-1	21	15																								
SIGN SUMMARY SHEET							SHEET TOTALS	24.19	0.00	0	0	0	10 7	0	0	3	45												
VERMONT AGENCY OF TRANSPORTATION							TOWN TOTALS	771.4	0.0	19.0	5.0	5.0	155	0.0	0.0	130	1950.0												

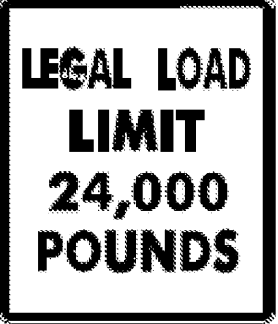



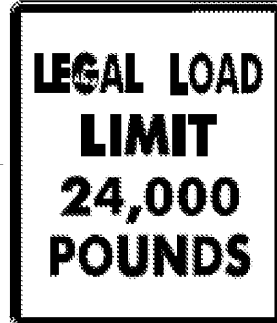

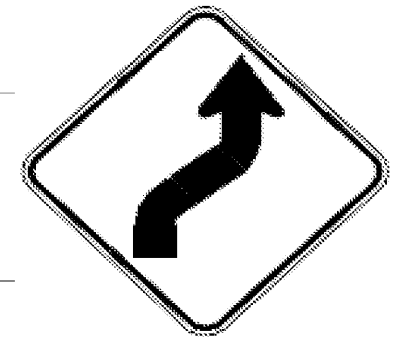
PROJECT NAME: **Hartford-East Montpelier VT14**
PROJECT NUMBER: **STPG SIGN(25)**
FILE NAME: **Randolph.xls** PLOT DATE: **6/18/2009**
PROJECT MANAGER: **N. Avery** DRAWN BY: **I. Shea**
DESIGNED BY: **D. Crossley** CHECKED BY: **S. Menard**
RANDOLPH SHEET 16 SHEET **79** OF **162**

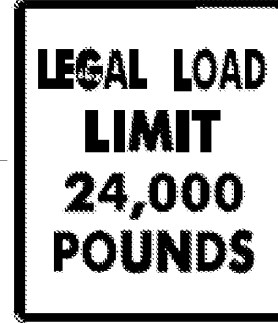
DIRECTION	MILEPOINT	LOCATION CODE (SHEET 2)	SIGN CODE	WIDTH (IN)	HEIGHT (IN)	SHEETING REMARKS	SIGN LEGEND	NEW SIGNS		EXISTING SIGNS				EXIST POST		NUMBER OF NEW POSTS	SQUARE STEEL (IN)			TUBULAR STEEL Ø (IN)				SIGN FRAME REQUIRED	REMARKS	SIGN DETAIL			
								"A"	"B"	RETAIN	SALVAGE FROM	SALVAGE TO	REMOVE	RETAIN	REMOVE		1.75	2.00	2.50	FOUNDATION						DETAIL IN SHS	DETAIL ON SHEET NUMBER	DETAIL ON STD SHEET NUMBER	
																	(LB / FT)			3.00	3.50	4.00	5.00						(LB / FT)
																	1.88	2.42	3.35				7.60	9.00	10.80	14.60			
RANDOLPH VT 14							FY-FLUORESCENT YELLOW FYG-FLUORESCENT YELLOW GREEN															"SHS"-STANDARD HIGHWAY SIGNS							
			F M4-5	24	12																								
			F M1-1	24	24																								
			F M6-1	21	15																								
			F M3-3	24	12							2.00											GREEN ON WHITE SHEETING	X					
			F M1-5	24	24							4.00													E-136B				
			F M6-3	21	15							2.19												GREEN ON WHITE SHEETING	X				
			F M3-4	24	12							2.00												GREEN ON WHITE SHEETING	X				
			F M1-5	24	24							4.00														E-136B			
			F M6-1	21	15							2.19													GREEN ON WHITE SHEETING	X			
			F M4-5	24	12							2.00													WHITE ON BLUE SHEETING	X			
			F M1-1	24	24							4.00														X			
			F M6-1	21	15							2.19													WHITE ON BLUE SHEETING	X			
SB	4.910		F M3-3	24	12																								
			F M1-5	24	24																								
			F M3-3	24	12							2.00														X			
SIGN SUMMARY SHEET							SHEET TOTALS	26.57	0.00	0	0	0	5	0	0	1	15								PROJECT NAME: Hartford-East Montpelier VT14				
VERMONT AGENCY OF TRANSPORTATION								SF	SF	EA	EA	EA	EA	EA	EA	EA	FT								PROJECT NUMBER: STPG SIGN(25)				
							TOWN TOTALS	771.4	0.0	19.0	5.0	5.0	155	0.0	0.0	130	1950.0								FILE NAME: Randolph.xls	PLOT DATE: 6/18/2009			
																								DESIGNED BY: D. Crosslev	DRAWN BY: I. Shea				
																								CHECKED BY: S. Menard	SHEET 80 OF 162				

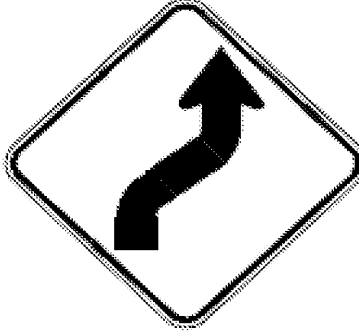
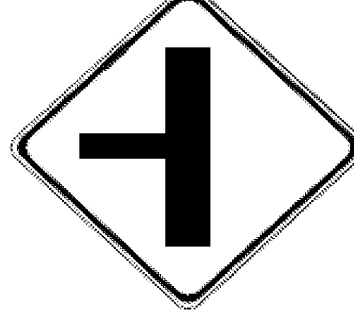



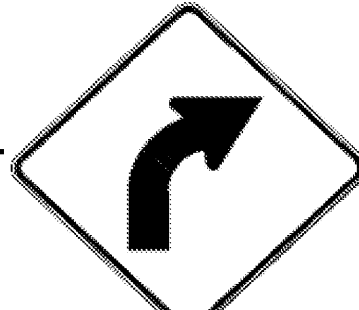

DIRECTION	MILEPOINT	LOCATION CODE (SHEET 2)	SIGN CODE	WIDTH (IN)	HEIGHT (IN)	SHEETING REMARKS	SIGN LEGEND FOR ALL POST LENGTHS AND INSTALLATION DATES SEE ORIGINAL RECORD PLANS	NEW SIGNS		EXISTING SIGNS				EXIST POST		NUMBER OF NEW POSTS	SQUARE STEEL (IN) (LB / FT)			TUBULAR STEEL Ø (IN) (LB / FT)				SIGN FRAME REQUIRED	REMARKS	SIGN DETAIL										
								"A"	"B"	RETAIN	SALVAGE FROM	SALVAGE TO	REMOVE	RETAIN	REMOVE		1.75	2.00	2.50	FOUNDATION	3.00	3.50	4.00			5.00	DETAIL IN SHS	DETAIL ON SHEET NUMBER	DETAIL ON STD SHEET NUMBER							
																	1.88	2.42	3.35		7.60	9.00	10.80			14.60										
RANDOLPH VT 14							FY-FLUORESCENT YELLOW FYG-FLUORESCENT YELLOW GREEN															"SHS"-STANDARD HIGHWAY SIGNS														
			F M1-5	24	24			4.00																					E-136B							
SB	4.890		F R2-1	30	36		SPEED LIMIT 35			1																										
SB	4.740		F D1-1A	54	7.5							1																								
			F D1-1A	54	7.5							1																								
			F D1-1A	72	12			6.00						2			X												5							
			F D1-1A	72	12			6.00																					5							
SB	4.690		F W5-2	30	30		NARROW BRIDGE						1				X																			
SB	4.640		F M3-3	24	12							1																								
			F M1-5	24	24							1																								
			F M3-3	24	12			2.00						1			X																			
			F M1-5	24	24			4.00																					E-136B							
SB	4.620		F W5-2	30	30			6.25						1			X																			
SB	4.600		F R2-1	24	30			5.00				1					X																			
SB	4.590		F OM-3R	12	36																															
			F OM-3R	12	36			3.00						1			X																			
SIGN SUMMARY SHEET							SHEET TOTALS	36.25	0.00	1	0	0	7 6	0	0	6	90																			
VERMONT AGENCY OF TRANSPORTATION							TOWN TOTALS	771.4	0.0	19.0	5.0	5.0	155	0.0	0.0	130	1950.0																			
																					PROJECT NAME: Hartford-East Montpelier VT14		PROJECT NUMBER: STPG SIGN(25)		FILE NAME: Randolph.xls		PLOT DATE: 6/18/2009		DESIGNED BY: D. Crossley		DRAWN BY: I. Shea		CHECKED BY: S. Menard		SHEET 81 OF 162	



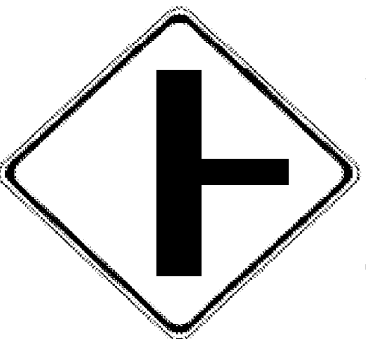
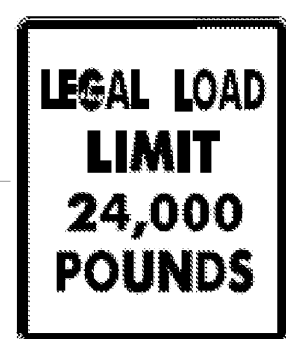

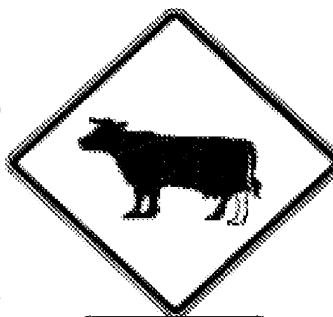
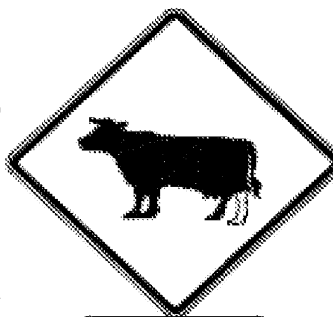

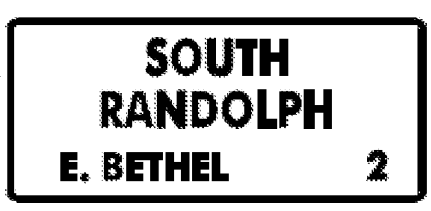
DIRECTION	MILEPOINT	LOCATION CODE (SHEET 2)	SIGN CODE	WIDTH (IN)	HEIGHT (IN)	SHEETING REMARKS	SIGN LEGEND	NEW SIGNS		EXISTING SIGNS				EXIST POST		NUMBER OF NEW POSTS	SQUARE STEEL (IN)			TUBULAR STEEL Ø (IN)				SIGN FRAME REQUIRED	REMARKS	SIGN DETAIL			
								"A"	"B"	RETAIN	SALVAGE FROM	SALVAGE TO	REMOVE	RETAIN	REMOVE		1.75	2.00	2.50	FOUNDATION	3.00	3.50	4.00			5.00	DETAIL IN SHS	DETAIL ON SHEET NUMBER	DETAIL ON STD SHEET NUMBER
																	(LB / FT)				(LB / FT)								
RANDOLPH VT 14							FY-FLUORESCENT YELLOW FYG-FLUORESCENT YELLOW GREEN															"SHS"-STANDARD HIGHWAY SIGNS							
SB	4.576	E	OM-3L	12	36																								
		E	OM-3L	12	36			3.00											X						X				
SB	4.520	F	W11-6H	30	30																								
		F	W11-6H	30	30			6.25											X							6			
SB	4.462	F	S1-1YG	30	30		SCHOOL SYMBOL																						
		F	W16-9YG	24	12		AHEAD																						
SB	4.343	F	W11-5	30	30		FARM MACHINERY SYMBOL																						
		F	W7-3A	24	18		NEXT 1 MILE																						
SB	4.299	F	VR-017	24	30																								
		F	VR-017	24	30			5.00											X							E-141			
SB	4.291	F	R1-1	30	30																								
		F	R1-1	30	30			6.25											X						X				
SB	4.227	F	R2-1	24	30		STOP																						
		F	VR-017	24	30																								
		F	VR-017	24	30			5.00											X							E-141			
SIGN SUMMARY SHEET							SHEET TOTALS	25.50	0.00	1	0	0	9	0	0	5	75												
VERMONT AGENCY OF TRANSPORTATION							TOWN TOTALS	771.4	0.0	19.0	5.0	5.0	155	0.0	0.0	130	1950.0												
								SF	SF	EA	EA	EA	EA	EA	EA	EA	FT												
																		PROJECT NAME: Hartford-East Montpelier VT14 PROJECT NUMBER: STPG SIGN(25) FILE NAME: Randolph.xls PLOT DATE: 6/18/2009 PROJECT MANAGER: N. Avery DRAWN BY: I. Shea DESIGNED BY: D. Crosslev CHECKED BY: S. Menard RANDOLPH SHEET 19 SHEET 82 OF 162											

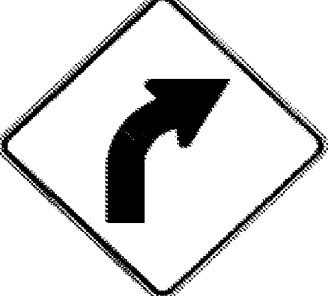

DIRECTION	MILEPOINT	LOCATION CODE (SHEET 2)	SIGN CODE	WIDTH (IN)	HEIGHT (IN)	SHEETING REMARKS	SIGN LEGEND	NEW SIGNS		EXISTING SIGNS				EXIST POST		NUMBER OF NEW POSTS	SQUARE STEEL (IN)			TUBULAR STEEL Ø (IN)				SIGN FRAME REQUIRED	REMARKS	SIGN DETAIL						
								"A"	"B"	RETAIN	SALVAGE FROM	SALVAGE TO	REMOVE	RETAIN	REMOVE		1.75	2.00	2.50	3.00	3.50	4.00	5.00			DETAIL IN SHS	DETAIL ON SHEET NUMBER	DETAIL ON STD SHEET NUMBER				
																	(LB / FT)			(LB / FT)												
																	1.88	2.42	3.35	FOUNDATION	7.60	9.00	10.80						14.60			
RANDOLPH VT 14							FY-FLUORESCENT YELLOW FYG-FLUORESCENT YELLOW GREEN															"SHS"-STANDARD HIGHWAY SIGNS										
SB	4.230	F	R1-1	30	30																											
		F	R1-1	30	30			6.25																	X							
SB	4.200	F	W2-2R	30	30		RIGHT SIDE ROAD																									
SB	4.113	G	VR-017	24	24																											
		G	VR-017	24	30			5.00																		E-141						
SB	4.105	H	R1-1	24	24																											
		H	R1-1	30	30			6.25																	X							
SB	4.055	F	R2-1	24	30		SPEED LIMIT 50			1																						
SB	4.020	F	W1-4R	30	30		RIGHT REVERSE CURVE																									
SB	3.980	F	VW-060	30	30		HIDDEN DRIVES																									
		F	W1-4R	30	30			6.25																	X							
		F	VW-060	30	30			6.25																		E-154						
SB	3.696	G	VR-017	24	24																											
		G	VR-017	24	30			5.00																		E-141						
SB	3.688	H	R1-1	24	24																											
SIGN SUMMARY SHEET							SHEET TOTALS	35.00	0.00	1	0	0	8	0	0	6	90								PROJECT NAME: Hartford-East Montpelier VT14							
							SF SF EA EA EA EA EA EA EA EA																				PROJECT NUMBER: STPG SIGN(25)					
VERMONT AGENCY OF TRANSPORTATION							TOWN TOTALS	771.4	0.0	19.0	5.0	5.0	155	0.0	0.0	130	1950.0								FILE NAME: Randolph.xls PLOT DATE: 6/18/2009							
																													PROJECT MANAGER: N. Avery DRAWN BY: I. Shea			
																														DESIGNED BY: D. Crosslev CHECKED BY: S. Menard		
																														RANDOLPH SHEET 20 SHEET 83 OF 162		



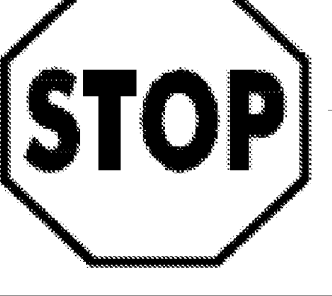
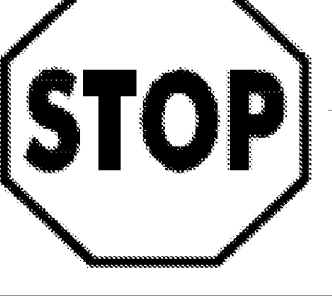

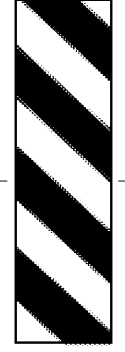
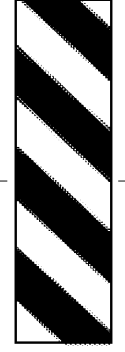

DIRECTION	MILEPOINT	LOCATION CODE (SHEET 2)	SIGN CODE	WIDTH (IN)	HEIGHT (IN)	SHEETING REMARKS	SIGN LEGEND	NEW SIGNS		EXISTING SIGNS				EXIST POST		NUMBER OF NEW POSTS	SQUARE STEEL (IN)			TUBULAR STEEL Ø (IN)				SIGN FRAME REQUIRED	REMARKS	SIGN DETAIL			
								"A"	"B"	RETAIN	SALVAGE FROM	SALVAGE TO	REMOVE	RETAIN	REMOVE		1.75	2.00	2.50	FOUNDATION	3.00	3.50	4.00			5.00	DETAIL IN SHS	DETAIL ON SHEET NUMBER	DETAIL ON STD SHEET NUMBER
																	(LB / FT)				(LB / FT)								
RANDOLPH VT 14							FY-FLUORESCENT YELLOW FYG-FLUORESCENT YELLOW GREEN															"SHS"-STANDARD HIGHWAY SIGNS							
		H	R1-1	30	30			6.25							1	X								X					
SB	3.650	F	W1-4R	30	30		RIGHT REVERSE CURVE						1		X														
SB	3.560	F	W1-4R	30	30			6.25							1	X									INSTALL 475' +/- SOUTH OF ORIGINAL LOCATION	X			
SB	3.380	F	W2-2mAL	30	30		SIDE ROAD LEFT						1		X														
		F	W5-2	30	30		NARROW BRIDGE						1																
SB	3.330	F	W2-2MaL	30	30			6.25							2	X									INSTALL 250'+/- SOUTH OF ORIGINAL LOCATION		6		
		F	W5-2	30	30			6.25																	X				
SB	3.269	F	OM-3R	12	36								1		X														
		F	OM-3R	12	36			3.00							1	X									X				
SB	3.261	E	OM-3L	12	36								1		X														
		E	OM-3L	12	36			3.00							1	X									X				
SB	2.780	F	W1-2R	30	30		RIGHT CURVE						1		X														
		F	W13-1	18	18		40 MPH PLAQUE						1																
SB	2.775	F	W1-2R	30	30			6.25							1	X									INSTALL 260'+/- SOUTH OF ORIGINAL LOCATION	X			
		F	W13-1	18	18			2.25																	X				
SIGN SUMMARY SHEET							SHEET TOTALS	39.50	0.00	0	0	0	7	0	0	7	105												
VERMONT AGENCY OF TRANSPORTATION							TOWN TOTALS	771.4	0.0	19.0	5.0	5.0	155	0.0	0.0	130	1950.0												
								SF	SF	EA	EA	EA	EA	EA	EA	EA	FT												

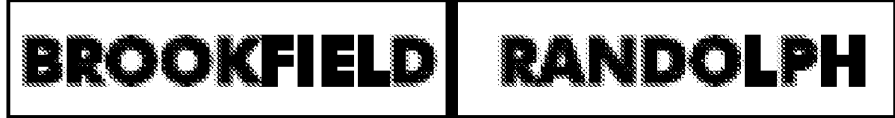
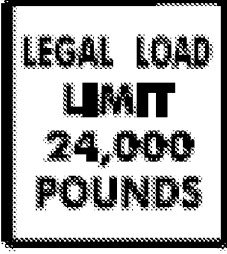

PROJECT NAME: **Hartford-East Montpelier VT14**
PROJECT NUMBER: **STPG SIGN(25)**
FILE NAME: **Randolph.xls** PLOT DATE: **6/18/2009**
PROJECT MANAGER: **N. Avery** DRAWN BY: **I. Shea**
DESIGNED BY: **D. Crosslev** CHECKED BY: **S. Menard**
RANDOLPH SHEET 21 SHEET **84** OF **162**

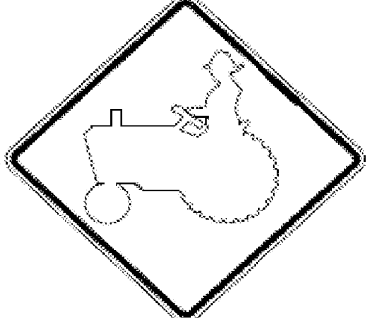
DIRECTION	MILEPOINT	LOCATION CODE (SHEET 2)	SIGN CODE	WIDTH (IN)	HEIGHT (IN)	SHEETING REMARKS	SIGN LEGEND FOR ALL POST LENGTHS AND INSTALLATION DATES SEE ORIGINAL RECORD PLANS	NEW SIGNS		EXISTING SIGNS				EXIST POST		NUMBER OF NEW POSTS	SQUARE STEEL (IN) (LB / FT)			TUBULAR STEEL Ø (IN) (LB / FT)				SIGN FRAME REQUIRED	REMARKS	SIGN DETAIL			
								"A"	"B"	RETAIN	SALVAGE FROM	SALVAGE TO	REMOVE	RETAIN	REMOVE		FOUNDATION	1.75	2.00	2.50	3.00	3.50	4.00			5.00	DETAIL IN SHS	DETAIL ON SHEET NUMBER	DETAIL ON STD SHEET NUMBER
																		1.88	2.42	3.35	7.60	9.00	10.80			14.60			
RANDOLPH VT 14							FY-FLUORESCENT YELLOW FYG-FLUORESCENT YELLOW GREEN															"SHS"-STANDARD HIGHWAY SIGNS							
SB	2.691	F	OM-3R	12	36			3.00							1	X							END OF STONE RET. WALL						
SB	2.137	F	W11-4	30	30		CATTLE SYMBOL 																						
		F	W16-2	24	18		700 FEET																						
		F	W2-2MaR	30	30			6.25							1	X									6				
SB	2.081	G	VR-017	24	24																		DAVIS RD TH-72						
		G	VR-017	24	30			5.00							1	X										E-141			
SB	2.077	H	R1-1	24	24																		DAVIS RD TH-72						
		H	R1-1	30	30			6.25							1	X								X					
	2.070	F	W11-4	30	30			6.25							1	X							INSTALL 100'+/- SOUTH OF DAVIS RD	X					
		F	W16-2	24	18			3.00																X					
SB	1.620	F	W1-2R	30	30		RIGHT CURVE																						
		F	W13-1	18	18		35 MPH PLAQUE																						
SB	1.580	F	VW-054R	30	30		HIDDEN DRIVE RIGHT																						
		F	VD-018	30	18			3.75							1	X										E-128B			
SB	1.550	F	VD-018	30	18		SOUTH RANDOLPH E. BETHEL 2																						
		F	VW-054R	30	30			6.25							1	X										E-154			
SIGN SUMMARY SHEET							SHEET TOTALS	39.75 36.75	0.00	0	0	0	6 8	0	0	7 6	90					PROJECT NAME: Hartford-East Montpelier VT14 PROJECT NUMBER: STPG SIGN(25)							
VERMONT AGENCY OF TRANSPORTATION							TOWN TOTALS	771.4	0.0	19.0	5.0	5.0	155	0.0	0.0	130	1950.0					FILE NAME: Randolph.xls PROJECT MANAGER: N. Avery DESIGNED BY: D. Crosslev RANDOLPH SHEET 22	PLOT DATE: 6/18/2009 DRAWN BY: I. Shea CHECKED BY: S. Menard SHEET 85 OF 162						







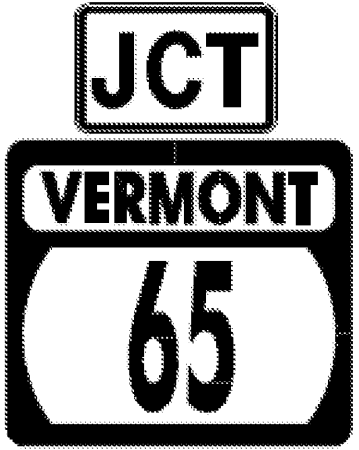
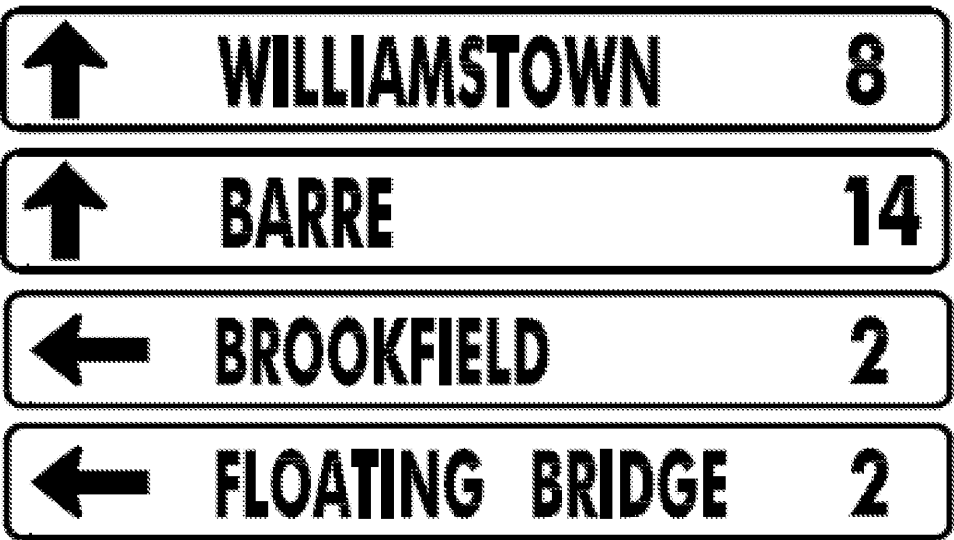

DIRECTION	MILEPOINT	LOCATION CODE (SHEET 2)	SIGN CODE	WIDTH (IN)	HEIGHT (IN)	SHEETING REMARKS	SIGN LEGEND FOR ALL POST LENGTHS AND INSTALLATION DATES SEE ORIGINAL RECORD PLANS	NEW SIGNS		EXISTING SIGNS				EXIST POST		NUMBER OF NEW POSTS	SQUARE STEEL (IN)			TUBULAR STEEL Ø (IN)				SIGN FRAME REQUIRED	REMARKS	SIGN DETAIL			
								"A"	"B"	RETAIN	SALVAGE FROM	SALVAGE TO	REMOVE	RETAIN	REMOVE		1.75	2.00	2.50	FOUNDATION	3.00	3.50	4.00			5.00	DETAIL IN SHS	DETAIL ON SHEET NUMBER	DETAIL ON STD SHEET NUMBER
																	(LB / FT)				(LB / FT)								
RANDOLPH VT 14							FY-FLUORESCENT YELLOW FYG-FLUORESCENT YELLOW GREEN															"SHS"-STANDARD HIGHWAY SIGNS							
SB	1.500	F	W1-2R	30	30			6.25							1		X							INSTALL 150' +/- SOUTH OF PREVIOUS SIGN	X				
		F	W13-1	18	18			2.25																	X				
SB	1.440	F	W2-2R	30	30		RIGHT SIDE ROAD								1														
SB	1.370	G	VR-017	24	24																			SOUTH RANDOLPH RD TH-71					
		G	VR-017	24	30			5.00							1		X										E-141		
SB	1.363	H	R1-1	30	30			6.25							1		X							INSTALL IN ISLAND	X				
SB	1.355	H	R1-1	24	24																								
		H	R1-1	30	30			6.25							1		X									X			
SB	1.310	F	VW-054R	30	30		HIDDEN DRIVE RIGHT																						
SB	1.280	F	M3-3	24	12		SOUTH																						
		F	M1-5	24	24		VERMONT 14																						
		F	VW-054R	30	30			6.25							1												E-154		
SB	1.120	F	W5-2	30	30		NARROW BRIDGE 																						
SB	1.080	F	W5-2	30	30			6.25							1		X							INSTALL 200' SOUTH OF ORIGINAL SIGN LOCATION	X				
SB	0.998	F	OM-3R	12	36																								
SIGN SUMMARY SHEET							SHEET TOTALS	38.50	0.00	0	0	0	8.00	0	0	6		90						PROJECT NAME: Hartford-East Montpelier VT14					
VERMONT AGENCY OF TRANSPORTATION								SF	SF	EA	EA	EA	EA	EA	EA	EA		FT						PROJECT NUMBER: STPG SIGN(25)					
							TOWN TOTALS	771.4	0.0	19.0	5.0	5.0	155	0.0	0.0	130		1950.0					FILE NAME: Randolph.xls	PLOT DATE: 6/18/2009					
																							PROJECT MANAGER: N. Avery	DRAWN BY: I. Shea					
																							DESIGNED BY: D. Crossley	CHECKED BY: S. Menard					
																							RANDOLPH SHEET 23	SHEET 86	OF 162				

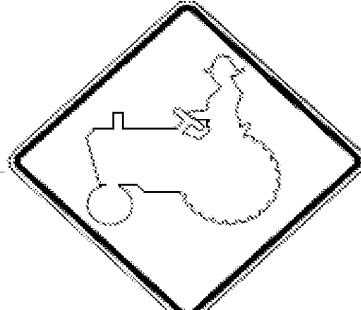



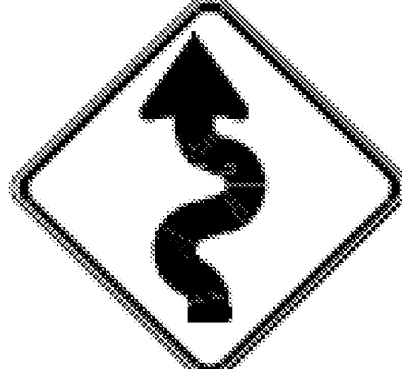
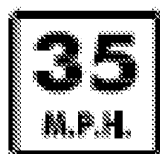

DIRECTION	MILEPOINT	LOCATION CODE (SHEET 2)	SIGN CODE	WIDTH (IN)	HEIGHT (IN)	SHEETING REMARKS	SIGN LEGEND	NEW SIGNS		EXISTING SIGNS			EXIST POST		NUMBER OF NEW POSTS	SQUARE STEEL (IN)			TUBULAR STEEL Ø (IN)				SIGN FRAME REQUIRED	REMARKS	SIGN DETAIL																
								"A"	"B"	RETAIN	SALVAGE FROM	SALVAGE TO	REMOVE	RETAIN		REMOVE	1.75	2.00	2.50	3.00	3.50	4.00			5.00	DETAIL IN SHS	DETAIL ON SHEET NUMBER	DETAIL ON STD SHEET NUMBER													
																	(LB / FT)			(LB / FT)																					
							FY-FLUORESCENT YELLOW FYG-FLUORESCENT YELLOW GREEN																"SHS"-STANDARD HIGHWAY SIGNS																		
			F OM-3R	12	36			3.00						1	X										X																
SB	0.990		E OM-3L	12	36							1																													
			E OM-3L	12	36			3.00						1	X										X																
SB	0.340		H R1-1	30	30			6.25						1	X										X																
SIGN SUMMARY SHEET								SHEET TOTALS		12.25	0.00	0	0	0	1	0	0	3	45																						
VERMONT AGENCY OF TRANSPORTATION								SF	SF	EA	EA	EA	EA	EA	EA	EA	EA	EA	EA	EA	EA	EA	EA	EA	EA	EA	EA														
TOWN TOTALS								771.4	0.0	19.0	5.0	5.0	155	0.0	0.0	130	1950.0																								
																				PROJECT NAME: Hartford-East Montpelier VT14		PLOT DATE: 6/18/2009																			
																				PROJECT NUMBER: STPG SIGN(25)		DRAWN BY: I. Shea																			
																				FILE NAME: Randolph.xls		DESIGNED BY: D. Crosslev																			
																				PROJECT MANAGER: N. Avery		CHECKED BY: S. Menard																			
																				RANDOLPH SHEET 24		SHEET 87 OF 162																			



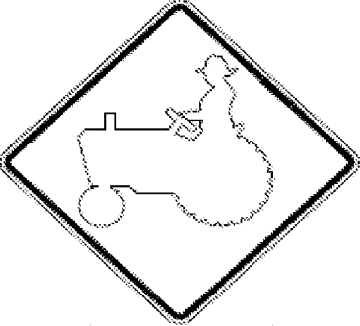

DIRECTION	MILEPOINT	LOCATION CODE (SHEET 2)	SIGN CODE	WIDTH (IN)	HEIGHT (IN)	SHEETING REMARKS	SIGN LEGEND FOR ALL POST LENGTHS AND INSTALLATION DATES SEE ORIGINAL RECORD PLANS	NEW SIGNS		EXISTING SIGNS				EXIST POST		NUMBER OF NEW POSTS	SQUARE STEEL (IN)			TUBULAR STEEL Ø (IN)				SIGN FRAME REQUIRED	REMARKS	SIGN DETAIL				
								"A"	"B"	RETAIN	SALVAGE FROM	SALVAGE TO	REMOVE	RETAIN	REMOVE		1.75	2.00	2.50	FOUNDATION	3.00	3.50	4.00			5.00	DETAIL IN SHS	DETAIL ON SHEET NUMBER	DETAIL ON STD SHEET NUMBER	
																	(LB / FT)				(LB / FT)									
BROOKFIELD VT 14							FY-FLUORESCENT YELLOW FYG-FLUORESCENT YELLOW GREEN															"SHS"-STANDARD HIGHWAY SIGNS								
NB	0.000	C	VD-024	72	10			0.84																2 MM PLAQUES @ 0.42 SF EA=0.84 SF		4				
NB	0.926	C	VR-017	24	30			5.00							1										MONTGOMERY RD TH54					
NB	0.934	D	R1-1	30	30			6.25							1															
		A	W14-2	30	30		NO OUTLET																							
NB	1.050	A	W11-5	30	30																									
		A	W7-3A	24	18																									
		A	W11-5	30	30			6.25							1												X			
		A	W7-3A	24	18			3.00																			X			
NB	2.920	A	OM-1	18	18		OBJECT MARKER																					REMOVED MM PLAQUE		
NB	3.100	A	R2-5A	24	30		REDUCED SPEED AHEAD																							
		A	VD-018	30	18			3.75							1														E-128B	
NB	3.230	A	R2-1	24	30																									
		A	R2-1	30	36			7.50							1														6	
NB	3.310	A	VD-062A	72	16		BUSINESS SIGN			1																				
NB	3.430	C	VR-017	24	24																								EAST HILL RD TH-9	
SIGN SUMMARY SHEET							SHEET TOTALS	37.59 36.75	0.00	1	0	0	8 7	0	0	7 6		90												
VERMONT AGENCY OF TRANSPORTATION							TOWN TOTALS	332.4	0.0	2.0	0.0	0.0	50	0.0	0.0	49		735.0												
PROJECT NAME: Hartford-East Montpelier VT14																					PROJECT NUMBER: STPG SIGN(21)									
FILE NAME: Brookfield.xls															PLOT DATE: 6/10/2009															
PROJECT MANAGER: N. Avery															DRAWN BY: T. Guazzoni															
DESIGNED BY: D. Crosslev															CHECKED BY: S. Menard															
BROOKFIELD SHEET 1																					SHEET 88 OF 162									

DIRECTION	MILEPOINT	LOCATION CODE (SHEET 2)	SIGN CODE	WIDTH (IN)	HEIGHT (IN)	SHEETING REMARKS	SIGN LEGEND	NEW SIGNS		EXISTING SIGNS				EXIST POST		NUMBER OF NEW POSTS	SQUARE STEEL (IN)			TUBULAR STEEL Ø (IN)				SIGN FRAME REQUIRED	REMARKS	SIGN DETAIL			
								"A"	"B"	RETAIN	SALVAGE FROM	SALVAGE TO	REMOVE	RETAIN	REMOVE		1.75	2.00	2.50	FOUNDATION	3.00	3.50	4.00			5.00	DETAIL IN SHS	DETAIL ON SHEET NUMBER	DETAIL ON STD SHEET NUMBER
																	(LB / FT)				(LB / FT)								
BROOKFIELD VT 14							FY-FLUORESCENT YELLOW FYG-FLUORESCENT YELLOW GREEN															"SHS"-STANDARD HIGHWAY SIGNS							
		C	VR-017	24	30			5.00								1	X								E-141				
NB	3.430	D	R1-1	24	24								1																
		D	R1-1	30	30			6.25								1	X							X					
NB	3.470	A	M2-1	21	15								1																
		A	M1-5	24	24																								
		A	M2-1	21	15				2.19									X						X	GREEN ON WHITE SHEETING				
		A	M1-5	24	24				4.00																E-136B				
NB	3.560	A	D1-1A	72	12			6.00									2	X								5			
		A	D1-1A	72	12				6.00																5				
		A	D1-1A	72	12				6.00																5				
		A	D1-1A	72	12				6.00																5				
NB	3.640	A	M3-4	24	12								1																
		A	M1-6	24	24								1																
		A	M6-1	21	15								1																
		A	M3-1	24	12								1																
SIGN SUMMARY SHEET							SHEET TOTALS	41.44	0.00	0	0	0	7	0	0	5		75											
VERMONT AGENCY OF TRANSPORTATION								SF	SF	EA	EA	EA	EA	EA	EA	EA		FT											
TOWN TOTALS							332.4	0.0	2.0	0.0	0.0	50	0.0	0.0	49		735.0												
							PROJECT NAME: Hartford-East Montpelier VT14															PROJECT NUMBER: STPG SIGN(21)							
							FILE NAME: Brookfield.xls															PLOT DATE: 6/10/2009							
							PROJECT MANAGER: N. Avery															DRAWN BY: T. Guazzoni							
							DESIGNED BY: D. Crosslev															CHECKED BY: S. Menard							
							BROOKFIELD SHEET 2															SHEET 89 OF 162							







DIRECTION	MILEPOINT	LOCATION CODE (SHEET 2)	SIGN CODE	WIDTH (IN)	HEIGHT (IN)	SHEETING REMARKS	SIGN LEGEND	NEW SIGNS		EXISTING SIGNS				EXIST POST		NUMBER OF NEW POSTS	SQUARE STEEL (IN)			TUBULAR STEEL Ø (IN)				SIGN FRAME REQUIRED	REMARKS	SIGN DETAIL										
								"A"	"B"	RETAIN	SALVAGE FROM	SALVAGE TO	REMOVE	RETAIN	REMOVE		1.75	2.00	2.50	3.00	3.50	4.00	5.00			DETAIL IN SHS	DETAIL ON SHEET NUMBER	DETAIL ON STD SHEET NUMBER								
								(LB / FT)							FOUNDATION		(LB / FT)																			
BROOKFIELD VT 14							FY-FLUORESCENT YELLOW FYG-FLUORESCENT YELLOW GREEN															"SHS"-STANDARD HIGHWAY SIGNS														
			A	M1-6	24	24							1																							
			A	M6-3	21	15																														
			A	M3-4	24	12									2	X																				
			A	M1-5	24	24		4.00																												E-136B
			A	M6-1	21	15		2.19																												
			A	M3-1	24	12		2.00																												
			A	M1-5	24	24		4.00																												E-136B
			A	M6-3	21	15		2.19																												
NB	3.650		C	W1-7	48	24							1																							
			C	W1-7	48	24		8.00																												X
NB	3.677		A	M3-1	24	12							1																							
			A	M1-5	24	24																														
			A	M3-1	24	12		2.00																												
			A	M1-5	24	24		4.00																												
NB	3.764		A	R2-1	24	30		5.00																												
							SIGN SUMMARY SHEET	SHEET TOTALS		35.38	0.00	0	0	0	5	0	0	6	90						PROJECT NAME: Hartford-East Montpelier VT14 PROJECT NUMBER: STPG SIGN(21)											
							VERMONT AGENCY OF TRANSPORTATION	SF	SF	EA	EA	EA	EA	EA	EA	EA	EA	FT						FILE NAME: Brookfield.xls PROJECT MANAGER: N. Avery DESIGNED BY: D. Crosslev BROOKFIELD SHEET 3												
							TOWN TOTALS	332.4	0.0	2.0	0.0	0.0	50	0.0	0.0	49	735.0							PLOT DATE: 6/10/2009 DRAWN BY: T. Guazzoni CHECKED BY: S. Menard SHEET 90 OF 162												

DIRECTION	MILEPOINT	LOCATION CODE (SHEET 2)	SIGN CODE	WIDTH (IN)	HEIGHT (IN)	SHEETING REMARKS	SIGN LEGEND	NEW SIGNS		EXISTING SIGNS				EXIST POST		NUMBER OF NEW POSTS	SQUARE STEEL (IN)			TUBULAR STEEL Ø (IN)				SIGN FRAME REQUIRED	REMARKS	SIGN DETAIL			
								"A"	"B"	RETAIN	SALVAGE FROM	SALVAGE TO	REMOVE	RETAIN	REMOVE		1.75	2.00	2.50	FOUNDATION	3.00	3.50	4.00			5.00	DETAIL IN SHS	DETAIL ON SHEET NUMBER	DETAIL ON STD SHEET NUMBER
																	(LB / FT)				(LB / FT)								
BROOKFIELD VT 14							FY-FLUORESCENT YELLOW FYG-FLUORESCENT YELLOW GREEN															"SHS"-STANDARD HIGHWAY SIGNS							
NB	3.800	A	W11-5	30	30			6.25							1	X							INSTALL OPPOSITE SB ALLIS STATE PARK SIGN	X					
		A	W7-3A	24	18			3.00																X					
NB	5.019	C	VR-017	24	30																		TAYLOR HILL RD TH-15			E-141			
		C	VR-017	24	30			5.00							1	X													
NB	5.027	D	R1-1	30	30																								
		D	R1-1	30	30			6.25							1	X								X					
NB	5.745	A	S3-1	30	30																								
		A	VW-054R	30	30																								
		A	S3-1	30	30			6.25							2	X								X					
		A	VW-054R	30	30			6.25																		E-154			
NB	6.050	A	VW-347 H	30	30																								
		A	VW-347 H	30	30			6.25							1	X										6			
NB	6.120	A	W1-5L	36	36			9.00							2	X							INSTALL 350'+/- NORTH OF PREVIOUS SIGN AT BEGINNING OF LEFT CURVE	X					
		A	W13-1	24	24			4.00															INSTALL ON LEFT POST	X					
		A	W7-3A	24	18			3.00															INSTALL ON RIGHT POST	X					
SIGN SUMMARY SHEET							SHEET TOTALS	55.25	0.00	0	0	0	5	0	0	8	120						PROJECT NAME: Hartford-East Montpelier VT14						
							SF	SF	EA	EA	EA	EA	EA	EA	EA	EA	FT					PROJECT NUMBER: STPG SIGN(21)							
VERMONT AGENCY OF TRANSPORTATION							TOWN TOTALS	332.4	0.0	2.0	0.0	0.0	50	0.0	0.0	49	735.0					FILE NAME: Brookfield.xls	PLOT DATE: 6/10/2009						
																				PROJECT MANAGER: N. Avery	DRAWN BY: T. Guazzoni								
																				DESIGNED BY: D. Crosslev	CHECKED BY: S. Menard								
																				BROOKFIELD SHEET 4	SHEET 91 OF 162								



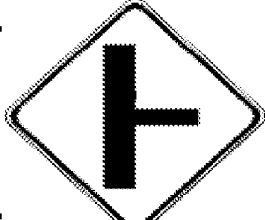
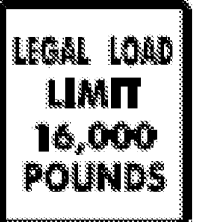

DIRECTION	MILEPOINT	LOCATION CODE (SHEET 2)	SIGN CODE	WIDTH (IN)	HEIGHT (IN)	SHEETING REMARKS	SIGN LEGEND FOR ALL POST LENGTHS AND INSTALLATION DATES SEE ORIGINAL RECORD PLANS	NEW SIGNS		EXISTING SIGNS				EXIST POST		NUMBER OF NEW POSTS	SQUARE STEEL (IN)			TUBULAR STEEL Ø (IN)				SIGN FRAME REQUIRED	REMARKS	SIGN DETAIL							
								"A"	"B"	RETAIN	SALVAGE FROM	SALVAGE TO	REMOVE	RETAIN	REMOVE		1.75	2.00	2.50	FOUNDATION	3.00	3.50	4.00			5.00	DETAIL IN SHS	DETAIL ON SHEET NUMBER	DETAIL ON STD SHEET NUMBER				
																	(LB / FT)				(LB / FT)												
BROOKFIELD VT 14							FY-FLUORESCENT YELLOW FYG-FLUORESCENT YELLOW GREEN															"SHS"-STANDARD HIGHWAY SIGNS											
NB	6.570	A	W1-2R	30	30		CURVE RIGHT																										
		A	W13-1	24	24		35 MPH PLAQUE																										
SB	5.940	F	VW-054L	30	30		HIDDEN DRIVE LEFT																										
SB	5.930	F	VW-054L	30	30										1		X												INSTALL 100' +/- SOUTH OF ORIGINAL LOCATION			E-154	
SB	4.395	G	VR-017	24	30																								TWIN POND RD TH-12			E-141	
SB	4.380	H	R1-1	30	30																									X			
SB	3.880	F	M2-1	21	15																												
		F	M1-5	24	24																												
		F	M2-1	21	15																												
		F	M1-5	24	24																												
SB	3.870	F	W11-5	30	30																									INSTALL 200' SOUTH OF ROUTE MARKER ASSEMBLY			X
		F	W7-3A	24	18																										X		
SB	3.800	F	VD-062A	72	16		BUSINESS SIGN			1																							
SB	3.780	F	VD-018	30	18																										E-128B		
SB	3.764	F	R2-1	24	30																												
SIGN SUMMARY SHEET							SHEET TOTALS	42.94 36.69	0.00	1	0	0	6	0	0	6	90								PROJECT NAME:	Hartford-East Montpelier VT14							
								SF	SF	EA	EA	EA	EA	EA	EA	EA	FT								PROJECT NUMBER:	STPG SIGN(21)							
							TOWN TOTALS	332.4	0.0	2.0	0.0	0.0	50	0.0	0.0	49	735.0								FILE NAME:	Brookfield.xls							
VERMONT AGENCY OF TRANSPORTATION																									DESIGNED BY:	D. Crossley							
																									PLOT DATE:	6/10/2009							
																										DRAWN BY:	T. Guazzoni						
																										CHECKED BY:	S. Menard						
																										SHEET	92 OF 162						





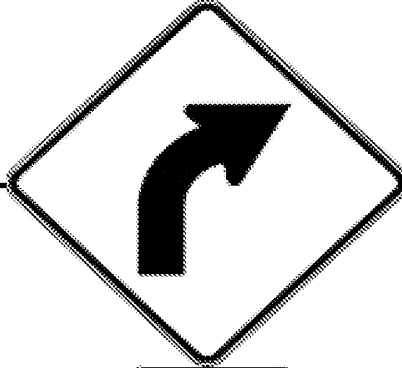

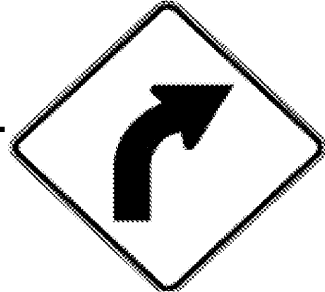
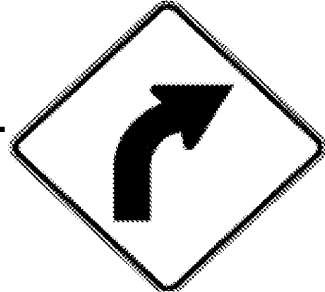
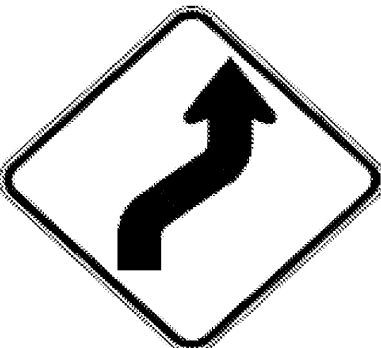
DIRECTION	MILEPOINT	LOCATION CODE (SHEET 2)	SIGN CODE	WIDTH (IN)	HEIGHT (IN)	SHEETING REMARKS	SIGN LEGEND	NEW SIGNS		EXISTING SIGNS				EXIST POST		NUMBER OF NEW POSTS	SQUARE STEEL (IN)			TUBULAR STEEL Ø (IN)				SIGN FRAME REQUIRED	REMARKS	SIGN DETAIL			
								"A"	"B"	RETAIN	SALVAGE FROM	SALVAGE TO	REMOVE	RETAIN	REMOVE		1.75	2.00	2.50	FOUNDATION	3.00	3.50	4.00			5.00	DETAIL IN SHS	DETAIL ON SHEET NUMBER	DETAIL ON STD SHEET NUMBER
																	(LB / FT)				(LB / FT)								
BROOKFIELD VT 14							FY-FLUORESCENT YELLOW FYG-FLUORESCENT YELLOW GREEN															"SHS"-STANDARD HIGHWAY SIGNS							
			F R2-1	30	36			7.50							1	X										6			
SB	3.722		F D1-1A	72	10																								
			F D1-1A	72	10																								
			F D1-1A	72	10																								
			F D1-1G	72	10																								
			F D1-1A	72	12			6.00							2	X													
			F D1-1A	72	12			6.00																					
			F D1-1A	72	12			6.00																					
			F D1-1G	72	12			6.00																					
SB	3.696		F M3-3	24	12																								
			F M1-5	24	24																								
			F M6-3	21	15																								
			F M3-4	24	12																								
			F M1-5	24	24																								
			F M6-1	21	15																								
SIGN SUMMARY SHEET							SHEET TOTALS	31.50	0.00	0	0	0	10	0	0	3	45						PROJECT NAME: Hartford-East Montpelier VT14						
							SF	SF	EA	EA	EA	EA	EA	EA	EA	EA	FT						PROJECT NUMBER: STPG SIGN(21)						
VERMONT AGENCY OF TRANSPORTATION							TOWN TOTALS	332.4	0.0	2.0	0.0	0.0	50	0.0	0.0	49	735.0						FILE NAME: Brookfield.xls						
																							PLOT DATE: 6/10/2009						
																							DRAWN BY: T. Guazzoni						
																							DESIGNED BY: D. Crosslev						
																							CHECKED BY: S. Menard						
																							SHEET 93 OF 162						

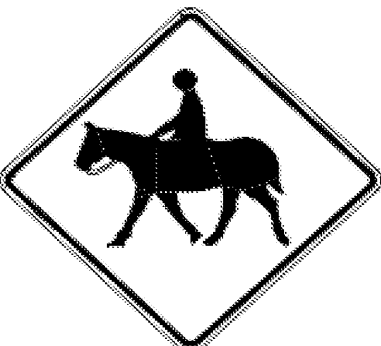



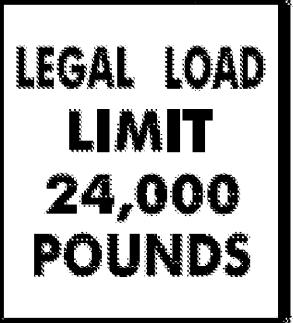

DIRECTION	MILEPOINT	LOCATION CODE (SHEET 2)	SIGN CODE	WIDTH (IN)	HEIGHT (IN)	SHEETING REMARKS	SIGN LEGEND	NEW SIGNS		EXISTING SIGNS				EXIST POST		NUMBER OF NEW POSTS	SQUARE STEEL (IN)			TUBULAR STEEL Ø (IN)				SIGN FRAME REQUIRED	REMARKS	SIGN DETAIL			
								"A"	"B"	RETAIN	SALVAGE FROM	SALVAGE TO	REMOVE	RETAIN	REMOVE		1.75	2.00	2.50	3.00	3.50	4.00	5.00			DETAIL IN SHS	DETAIL ON SHEET NUMBER	DETAIL ON STD SHEET NUMBER	
																	(LB / FT)			(LB / FT)									
BROOKFIELD VT 14							FY-FLUORESCENT YELLOW FYG-FLUORESCENT YELLOW GREEN															"SHS"-STANDARD HIGHWAY SIGNS							
			F M3-3	24	12			2.00								2	X						2	GREEN ON WHITE SHEETING	X				
			F M1-5	24	24			4.00																		E-136B			
			F M6-3	21	15			2.19																GREEN ON WHITE SHEETING	X				
			F M3-4	24	12			2.00																GREEN ON WHITE SHEETING	X				
			F M1-5	24	24			4.00																		E-136B			
			F M6-1	21	15			2.19																GREEN ON WHITE SHEETING	X				
SB	3.640		F W11-8	30	30							1		X															
			F W11-8	30	30			6.25								1	X								X				
SB	3.580		G VR-017	24	30										1	X							FIRE DEPT LN TH-71			E-141			
SB	3.573		G VR-017	24	24		LEGAL LOAD LIMIT 24,000 LBS					1		X															
			H R1-1	24	24							1																	
			H R1-1	30	30			6.25								1	X								X				
SB	3.567		H R1-1	30	30			6.25								1	X								X				
SB	3.535		F M3-3S	24	12							1		X															
			F M1-5	24	24							1																	
SIGN SUMMARY SHEET							SHEET TOTALS	40.13	0.00	0	0	0	5	0	0	6	90							PROJECT NAME: Hartford-East Montpelier VT14					
							SF SF EA EA EA EA EA EA EA EA								FT									PROJECT NUMBER: STPG SIGN(21)					
VERMONT AGENCY OF TRANSPORTATION							TOWN TOTALS	332.4	0.0	2.0	0.0	0.0	50	0.0	0.0	49	735.0								FILE NAME: Brookfield.xls				
																									PLOT DATE: 6/10/2009				
																										PROJECT MANAGER: N. Avery			
																										DRAWN BY: T. Guazzoni			
																										DESIGNED BY: D. Crosslev			
																											CHECKED BY: S. Menard		
																											SHEET 94 OF 162		

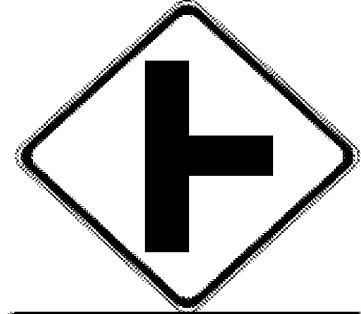

DIRECTION	MILEPOINT	LOCATION CODE (SHEET 2)	SIGN CODE	WIDTH (IN)	HEIGHT (IN)	SHEETING REMARKS	SIGN LEGEND FY-FLUORESCENT YELLOW FYG-FLUORESCENT YELLOW GREEN FOR ALL POST LENGTHS AND INSTALLATION DATES SEE ORIGINAL RECORD PLANS	NEW SIGNS		EXISTING SIGNS				EXIST POST		NUMBER OF NEW POSTS	SQUARE STEEL (IN)			TUBULAR STEEL Ø (IN)				SIGN FRAME REQUIRED	REMARKS	SIGN DETAIL			
								"A"	"B"	RETAIN	SALVAGE FROM	SALVAGE TO	REMOVE	RETAIN	REMOVE		1.75	2.00	2.50	FOUNDATION	3.00	3.50	4.00			5.00	DETAIL IN SHS	DETAIL ON SHEET NUMBER	DETAIL ON STD SHEET NUMBER
																	(LB / FT)				(LB / FT)								
BROOKFIELD VT 14																					"SHS"-STANDARD HIGHWAY SIGNS								
		F	M3-3S	24	12			2.00						1	X							GREEN ON WHITE SHEETING	X						
		F	M1-5	24	24			4.00																	E-136B				
SB	3.490	F	W11-5	30	30			6.25						1	X								X						
		F	W7-3A	24	18			3.00																X					
SB	3.230	F	R2-1	24	30																								
		F	R2-1	24	30			5.00						1	X								X						
SB	2.916	G	VR-017	24	24																								
		G	VR-017	24	30			5.00						1	X										E-141				
SB	2.908	H	R1-1	24	24																								
		H	R1-1	30	30			6.25							1	X							X						
SB	2.400	F	W2-2R	30	30	RIGHT SIDE ROAD								1	X														
SB	2.370	F	W2-2MaR	30	30			6.25						1	X									6					
SB	2.235	G	VR-017	24	30			5.00																					
								5.00																					
SB	2.231	H	R1-1	30	30			6.25						1	X								X						
SB	2.227	H	R1-1	30	30			6.25						1	X									X					
SIGN SUMMARY SHEET							SHEET TOTALS	60.25	0.00	0	0	0	4	0	0	11	135					PROJECT NAME: Hartford-East Montpelier VT14							
								55.25									FT				PROJECT NUMBER: STPG SIGN(21)								
								SF	SF	EA	EA	EA	EA	EA	EA	EA					FILE NAME: Brookfield.xls								
VERMONT AGENCY OF TRANSPORTATION							TOWN TOTALS	332.4	0.0	2.0	0.0	0.0	50	0.0	0.0	49	735.0					PROJECT MANAGER: N. Avery							
																					DESIGNED BY: D. Crosslev								
																					BROOKFIELD SHEET 8								
																					PLOT DATE: 6/10/2009								
																					DRAWN BY: T. Guazzoni								
																					CHECKED BY: S. Menard								
																					SHEET 95				OF 162				

DIRECTION	MILEPOINT	LOCATION CODE (SHEET 2)	SIGN CODE	WIDTH (IN)	HEIGHT (IN)	SHEETING REMARKS	SIGN LEGEND FOR ALL POST LENGTHS AND INSTALLATION DATES SEE ORIGINAL RECORD PLANS	NEW SIGNS		EXISTING SIGNS				EXIST POST		NUMBER OF NEW POSTS	SQUARE STEEL (IN)			TUBULAR STEEL Ø (IN)				SIGN FRAME REQUIRED	REMARKS	SIGN DETAIL			
								"A"	"B"	RETAIN	SALVAGE FROM	SALVAGE TO	REMOVE	RETAIN	REMOVE		1.75	2.00	2.50	FOUNDATION	3.00	3.50	4.00			5.00	DETAIL IN SHS	DETAIL ON SHEET NUMBER	DETAIL ON STD SHEET NUMBER
																	(LB / FT)				(LB / FT)								
BROOKFIELD VT 14							FY-FLUORESCENT YELLOW FYG-FLUORESCENT YELLOW GREEN															"SHS"-STANDARD HIGHWAY SIGNS							
SB	0.000	G	VD-024	60	7.5	TOWN LINE SIGN					43		X										2 MM PLAQUES SEE NB, PAGE 88						
SIGN SUMMARY SHEET							SHEET TOTALS	0.00	0.00	0	0	0	43	0	0	0								PROJECT NAME: Hartford-East Montpelier VT14 PROJECT NUMBER: STPG SIGN(21)					
VERMONT AGENCY OF TRANSPORTATION							TOWN TOTALS	332.4	0.0	2.0	0.0	0.0	50	0.0	0.0	49				735.0				FILE NAME: Brookfield.xls PROJECT MANAGER: N. Avery DESIGNED BY: D. Crossley BROOKFIELD SHEET 9	PLOT DATE: 6/10/2009 DRAWN BY: T. Guazzoni CHECKED BY: S. Menard SHEET 96 OF 162				

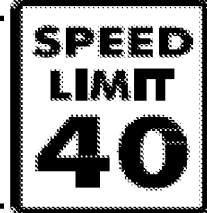

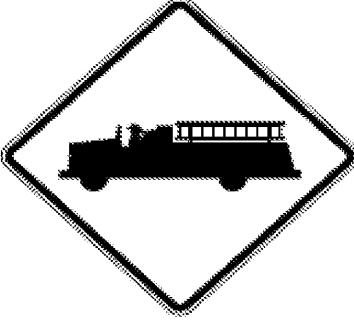

DIRECTION	MILEPOINT	LOCATION CODE (SHEET 2)	SIGN CODE	WIDTH (IN)	HEIGHT (IN)	SHEETING REMARKS	SIGN LEGEND	NEW SIGNS		EXISTING SIGNS				EXIST POST		NUMBER OF NEW POSTS	SQUARE STEEL (IN)			TUBULAR STEEL Ø (IN)				SIGN FRAME REQUIRED	REMARKS	SIGN DETAIL								
								"A"	"B"	RETAIN	SALVAGE FROM	SALVAGE TO	REMOVE	RETAIN	REMOVE		1.75	2.00	2.50	FOUNDATION	3.00	3.50	4.00			5.00	DETAIL IN SHS	DETAIL ON SHEET NUMBER	DETAIL ON STD SHEET NUMBER					
																	(LB / FT)				(LB / FT)													
WILLIAMSTOWN VT 14							FY-FLUORESCENT YELLOW FYG-FLUORESCENT YELLOW GREEN															"SHS"-STANDARD HIGHWAY SIGNS												
NB	0.000	A	W1-5	30	30		WINDING RD																											
		A	W13-1	18	18		35 MPH PLAQUE																											
NB	0.000 TO 0.340	A		6	8		36 WHITE DELINEATORS	12.00										X										INSTALL BACK TO BACK AT 100' SPACING, STARTING ACROSS FROM TOWN LINE SIGN		5				
NB	0.785	A	W1-2R	30	30		CURVE RIGHT																											
		A	W13-1	24	24		40 MPH PLAQUE																											
NB	0.870	A	W1-2R	30	30	FY	 	6.25											X										INSTALL 450 FT +/- NORTH OF EXISTING (TO BE REMOVED)	X				
		A	W13-1	24	24	FY			4.00																							X		
NB	1.210	A	W1-2L	30	30	FY		6.25											X												INSTALL ACROSS FROM SB GUARDRAIL TERMINUS	X		
NB	1.445	A	W1-4R	30	30		REVERSE CURVE																											
		A	W13-1	24	24		PLAQUE																											
NB	1.520	A	W1-4R	30	30		 	6.25												X											INSTALL 80 FT +/- NORTH OF GRAVEL DRIVE	X		
		A	W13-1	24	24				4.00																							X		
NB	1.860	A	W11-2	30	30		PEDESTRIAN																											
		A	W11-7	30	30			6.25												X												X		
NB	1.950	A	W11-7	30	30																													
SIGN SUMMARY SHEET							SHEET TOTALS	45.00	0.00	0	0	0	8	0	0	22	330																	
VERMONT AGENCY OF TRANSPORTATION								SF	SF	EA	EA	EA	EA	EA	EA	EA	FT																	
							TOWN TOTALS	501.1	0.0	67.0	0.0	0.0	94	0.0	0.0	109	1635.0																	
																						PROJECT NAME:	Hartford-East Montpelier VT14											
																						PROJECT NUMBER:	SIGN STPG(21)											
																						FILE NAME:	Williamstown.xls											
																						PROJECT MANAGER:	N. Avery											
																						DESIGNED BY:	A. Gamble											
																						WILLIAMSTOWN SHEET	1											
																						PLOT DATE:	6/18/2009											
																						DRAWN BY:	T. Guazzoni											
																						CHECKED BY:	S. Menard											
																						SHEET	97 OF 162											

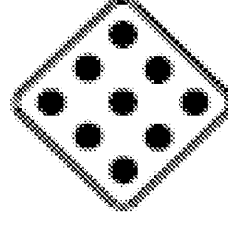



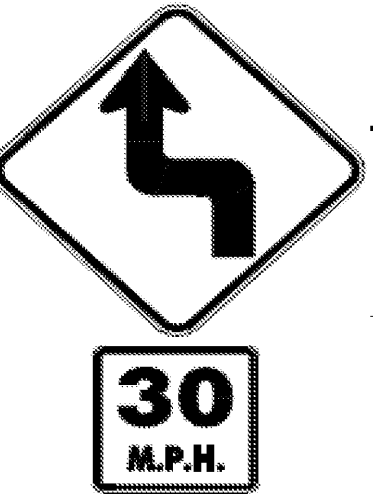

DIRECTION	MILEPOINT	LOCATION CODE (SHEET 2)	SIGN CODE	WIDTH (IN)	HEIGHT (IN)	SHEETING REMARKS	SIGN LEGEND	NEW SIGNS		EXISTING SIGNS				EXIST POST		NUMBER OF NEW POSTS	SQUARE STEEL (IN)			TUBULAR STEEL Ø (IN)				SIGN FRAME REQUIRED	REMARKS	SIGN DETAIL		
								"A"	"B"	RETAIN	SALVAGE FROM	SALVAGE TO	REMOVE	RETAIN	REMOVE		1.75	2.00	2.50	FOUNDATION						DETAIL IN SHS	DETAIL ON SHEET NUMBER	DETAIL ON STD SHEET NUMBER
																				3.00	3.50	4.00	5.00					
(LB / FT)																1.88	2.42	3.35	7.60	9.00	10.80	14.60						
WILLIAMSTOWN VT 14							FY-FLUORESCENT YELLOW FYG-FLUORESCENT YELLOW GREEN															"SHS"-STANDARD HIGHWAY SIGNS						
			A	W11-2	30	30	FYG		6.25										X					X				
NB	2.195		A	VW-054	30	30	HIDDEN DRIVE RIGHT							1			X						REMOVE AND DO NOT REPLACE HIDDEN DRIVE SIGN					
			A	W11A-2	30	30								1														
			A	W16-2	24	18								1														
			A	W11-2	30	30	FYG		6.25											X					X			
			A	W16-2	24	18	FYG		3.00															X				
NB	3.365		C	VR-017	24	24								1			X											
			C	VR-017	24	30			5.00										X						TH-3, CHELSEA RD		E-141	
NB	3.375		D	R1-1	24	24								1			X											
			D	R1-1	30	30			6.25										X						TH-3, CHELSEA RD		X	
NB	3.390		A	M3-1	24	12			2.00											X						INSTALL 25 FT +/- NORTH OF CHELSEA RD. GREEN ON WHITE		X
			A	M1-5	24	24			4.00																		E-136B	
NB	3.405		A	VW-054R	30	30	HIDDEN DRIVE RIGHT							1			X											
NB	3.425		A	W1-4R	30	30			6.25											X						INSTALL 100 FT +/- NORTH OF EXISTING HIDDEN DRIVE SIGN (TO BE REMOVED)		X
			A	VW-054	30	30			6.25																		E-154	
SIGN SUMMARY SHEET							SHEET TOTALS	45.25	0.00	0	0	0	6	0	0	7	105							PROJECT NAME: Hartford-East Montpelier VT14				
								SF	SF	EA	EA	EA	EA	EA	EA	EA	FT							PROJECT NUMBER: SIGN STPG(21)				
VERMONT AGENCY OF TRANSPORTATION							TOWN TOTALS	501.1	0.0	67.0	0.0	0.0	94	0.0	0.0	109	1635.0						FILE NAME: Williamstown.xls	PLOT DATE: 6/18/2009				
																						PROJECT MANAGER: N. Avery	DRAWN BY: T. Guazzoni					
																						DESIGNED BY: A. Gamble	CHECKED BY: S. Menard					
																						WILLIAMSTOWN SHEET 2	SHEET 98 OF 162					

DIRECTION	MILEPOINT	LOCATION CODE (SHEET 2)	SIGN CODE	WIDTH (IN)	HEIGHT (IN)	SHEETING REMARKS	SIGN LEGEND	NEW SIGNS		EXISTING SIGNS				EXIST POST		NUMBER OF NEW POSTS	SQUARE STEEL (IN)			TUBULAR STEEL Ø (IN)				SIGN FRAME REQUIRED	REMARKS	SIGN DETAIL			
								"A"	"B"	RETAIN	SALVAGE FROM	SALVAGE TO	REMOVE	RETAIN	REMOVE		1.75	2.00	2.50	FOUNDATION	3.00	3.50	4.00			5.00	DETAIL IN SHS	DETAIL ON SHEET NUMBER	DETAIL ON STD SHEET NUMBER
																	(LB / FT)				(LB / FT)								
WILLIAMSTOWN VT 14							FY-FLUORESCENT YELLOW FYG-FLUORESCENT YELLOW GREEN															"SHS"-STANDARD HIGHWAY SIGNS							
NB	3.640	A	R2-5A	24	30		REDUCED SPEED AHEAD 						1		X														
		A	W3-5	36	36			9.00								2		X								X			
NB	3.690	A	VD-018	30	18								1		X														
		A	VD-018	30	18			3.75								1		X											E-128B
NB	3.760	A	VW-202	30	30		TRUCKS ENTERING (TEXT) 						1		X														
		A	W2-2aL	30	30			6.25								1		X											6
		A	W16-8	30	8			1.67																					7
NB	3.800	A	R2-1	30	36			7.50								1		X											INSTALL 10 FT SOUTH OF UTILITY POLE
NB	3.910	A	R2-1	24	30		SPEED LIMIT 40					1			X														
NB	3.980	A	W11-2	30	30		PEDESTRIAN					1			X														
		A	W16-4	24	18		NEXT 700 FT 						1																
		A	W16-4	24	18	FYG		3.00																		X			
NB	4.020	A	R2-5A	24	30		REDUCED SPEED AHEAD						1		X														
NB	4.066	C	VR-017	24	30		LEGAL LOAD LIMIT 24000 LBS					1			X													BUSINESS CTR RD TH-99	
	4.074	D	R1-1	30	30		STOP					1			X														
SIGN SUMMARY SHEET							SHEET TOTALS	31.17	0.00	4	0	0	5	0	0	5	75							PROJECT NAME: Hartford-East Montpelier VT14					
								SF	SF	EA	EA	EA	EA	EA	EA	EA	FT							PROJECT NUMBER: SIGN STPG(21)					
VERMONT AGENCY OF TRANSPORTATION							TOWN TOTALS	501.1	0.0	67.0	0.0	0.0	94	0.0	0.0	109	1635.0							FILE NAME: Williamstown.xls					
																								PLOT DATE: 6/18/2009					
																								DRAWN BY: T. Guazzoni					
																								DESIGNED BY: A. Gamble					
																								CHECKED BY: S. Menard					
																								SHEET 99 OF 162					

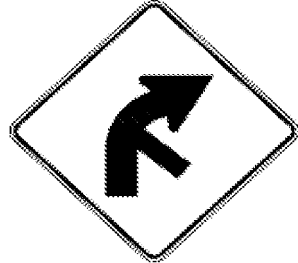

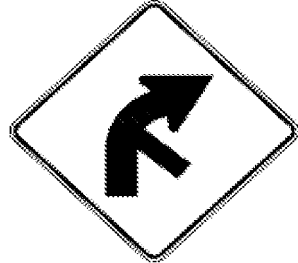
DIRECTION	MILEPOINT	LOCATION CODE (SHEET 2)	SIGN CODE	WIDTH (IN)	HEIGHT (IN)	SHEETING REMARKS	SIGN LEGEND	NEW SIGNS		EXISTING SIGNS				EXIST POST		NUMBER OF NEW POSTS	SQUARE STEEL (IN)			TUBULAR STEEL Ø (IN)				SIGN FRAME REQUIRED	REMARKS	SIGN DETAIL			
								"A"	"B"	RETAIN	SALVAGE FROM	SALVAGE TO	REMOVE	RETAIN	REMOVE		1.75	2.00	2.50	FOUNDATION	3.00	3.50	4.00			5.00	DETAIL IN SHS	DETAIL ON SHEET NUMBER	DETAIL ON STD SHEET NUMBER
																	(LB / FT)				(LB / FT)								
WILLIAMSTOWN VT 14							FY-FLUORESCENT YELLOW FYG-FLUORESCENT YELLOW GREEN															"SHS"-STANDARD HIGHWAY SIGNS							
NB	4.150	A	R2-1	24	30																								
		A	R2-1	30	36			7.50																	6				
NB	4.190	A	W11A-2	30	30	PEDESTRIAN																							
NB	4.310	A	W11-8	30	30																								
		A	W11-8	30	30			6.25																	X				
NB	4.370	A	R2-1	24	30																								
		A	R2-1	24	30			5.00																	X				
NB	4.400	A	M2-1	21	15																								
		A	M1-5	24	24																								
		A	M2-1	21	15			2.19																	X				
		A	M1-5	24	24			4.00																		E-136B			
NB	4.409	C	OM1-1	18	18																								
		C	OM1-1	18	18			2.25																	X				
NB	4.410	C	VR-017	24	24	LEGAL LOAD LIMIT 24000 LBS				1															TH-72, DEPOT ST				
NB	4.415	D	R1-1	24	24	STOP				1															TH-72, DEPOT ST				
SIGN SUMMARY SHEET							SHEET TOTALS		27.19	0.00	2	0	0	7	0	0	5	75					PROJECT NAME: Hartford-East Montpelier VT14						
							SF	SF	EA	EA	EA	EA	EA	EA	EA	EA	EA	FT					PROJECT NUMBER: SIGN STPG(21)						
VERMONT AGENCY OF TRANSPORTATION							TOWN TOTALS		501.1	0.0	67.0	0.0	0.0	94	0.0	0.0	109	1635.0					FILE NAME: Williamstown.xls						
																							PLOT DATE: 6/18/2009						
																							DRAWN BY: T. Guazzoni						
																							DESIGNED BY: A. Gamble						
																							CHECKED BY: S. Menard						
																							SHEET 100 OF 162						







DIRECTION	MILEPOINT	LOCATION CODE (SHEET 2)	SIGN CODE	WIDTH (IN)	HEIGHT (IN)	SHEETING REMARKS	SIGN LEGEND FOR ALL POST LENGTHS AND INSTALLATION DATES SEE ORIGINAL RECORD PLANS	NEW SIGNS		EXISTING SIGNS				EXIST POST		NUMBER OF NEW POSTS	SQUARE STEEL (IN)			TUBULAR STEEL Ø (IN)				SIGN FRAME REQUIRED	REMARKS	SIGN DETAIL			
								"A"	"B"	RETAIN	SALVAGE FROM	SALVAGE TO	REMOVE	RETAIN	REMOVE		1.75	2.00	2.50	FOUNDATION	3.00	3.50	4.00			5.00	DETAIL IN SHS	DETAIL ON SHEET NUMBER	DETAIL ON STD SHEET NUMBER
																	(LB / FT)				(LB / FT)								
WILLIAMSTOWN VT 14							FY-FLUORESCENT YELLOW FYG-FLUORESCENT YELLOW GREEN															"SHS"-STANDARD HIGHWAY SIGNS							
NB	4.440	C	VR-017	24	30		LEGAL LOAD LIMIT 24000 LBS	5.00							1		X							REMOVED EXISTING TH-71, BECKETT ST					
																								REMOVED EXISTING TH-71, BECKETT ST					
NB	4.470	A	D1-1A	72	10		UP ARROW BARRE 6																	RETAIN - ASSEMBLY TO BE REPLACED BY WILLIAMSTOWN BRS0204(4)					
			A	M3-4S	24	12	WEST																						
			A	M1-5	24	24	VT 64																						
			A	M6-11	21	15	LEFT ARROW																						
			A	M4-5I	24	12	TO																						
			A	M1-1	24	24	I-89																						
			A	M6-1S	21	15	LEFT ARROW																						
			A	M3-1S	24	12	NORTH																						
			A	M1-5	24	24	VT 14																						
			A	M6-3S	21	15	UP ARROW																						
NB	4.480	C	D1-1	72	10		<--- SOUTH BARRE																	RETAIN - ASSEMBLY TO BE REPLACED BY WILLIAMSTOWN BRS0204(4)					
			D1-1	72	10		BROOKFIELD ---.																						
			M3-1	24	12		NORTH																						
SIGN SUMMARY SHEET							SHEET TOTALS	11.25	0.00	13	0	0	2	30										PROJECT NAME: Hartford-East Montpelier VT14					
VERMONT AGENCY OF TRANSPORTATION							TOWN TOTALS	501.1	0.0	67.0	0.0	0.0	94	0.0	0.0	109	1635.0							PROJECT NUMBER: SIGN STPG(21)					
								SF	SF	EA	EA	EA	EA	EA	EA	EA	EA	EA	EA	EA	EA	EA	EA	FILE NAME: Williamstown.xls					
																								PROJECT MANAGER: N. Avery					
																								DESIGNED BY: A. Gamble					
																								WILLIAMSTOWN SHEET 5					
																								PLOT DATE: 6/18/2009					
																								DRAWN BY: T. Guazzoni					
																								CHECKED BY: S. Menard					
																								SHEET 101	OF	162			

DIRECTION	MILEPOINT	LOCATION CODE (SHEET 2)	SIGN CODE	WIDTH (IN)	HEIGHT (IN)	SHEETING REMARKS	SIGN LEGEND	NEW SIGNS		EXISTING SIGNS				EXIST POST		NUMBER OF NEW POSTS	SQUARE STEEL (IN)			TUBULAR STEEL Ø (IN)				SIGN FRAME REQUIRED	REMARKS	SIGN DETAIL			
								"A"	"B"	RETAIN	SALVAGE FROM	SALVAGE TO	REMOVE	RETAIN	REMOVE		1.75	2.00	2.50	FOUNDATION	3.00	3.50	4.00			5.00	DETAIL IN SHS	DETAIL ON SHEET NUMBER	DETAIL ON STD SHEET NUMBER
																	(LB / FT)				(LB / FT)								
WILLIAMSTOWN VT 14							FY-FLUORESCENT YELLOW FYG-FLUORESCENT YELLOW GREEN															"SHS"-STANDARD HIGHWAY SIGNS							
			A	M1-5	24	24																							
			A	M3-1	24	12			2.00												X					X			
			A	M1-5	24	24			4.00																		E-136B		
NB	4.585		A	R2-1	24	30																							
			A	R2-1	24	30			5.00												X					X			
NB	4.715		A	W1-3L	30	30	REVERSE TURN																						
			A	W13-1	18	18	30 MPH PLAQUE																						
																													
NB	4.780		A	W1-3L	30	30			6.25												X					X			
			A	W13-1	18	18		2.25																	X				
NB	4.790		C	VR-017	24	24	LEGAL LOAD LIMIT 24000 LBS			1																TH 25, CIRCLE ST			
NB	4.800		D	R1-1	24	24	STOP			1																TH 25, CIRCLE ST			
NB	4.900		A	R2-1	24	30																							
			A	R2-1	24	30			5.00												X					X			
NB	5.380		C	VR-017	24	30	LEGAL LOAD LIMIT 24000 LBS			1																TH-12, BROCKWAY RD			
NB	5.390		D	R1-1	30	30	STOP			1																TH-12, BROCKWAY RD			
SIGN SUMMARY SHEET							SHEET TOTALS	24.50	0.00	4	0	0	5	0	0	4	60							PROJECT NAME: Hartford-East Montpelier VT14					
VERMONT AGENCY OF TRANSPORTATION							TOWN TOTALS	501.1	0.0	67.0	0.0	0.0	94	0.0	0.0	109	1635.0							PROJECT NUMBER: SIGN STPG(21)					
																							FILE NAME: Williamstown.xls PLOT DATE: 6/18/2009						
																								PROJECT MANAGER: N. Avery DRAWN BY: T. Guazzoni					
																								DESIGNED BY: A. Gamble CHECKED BY: S. Menard					
																									WILLIAMSTOWN SHEET 7 SHEET 103 OF 162				

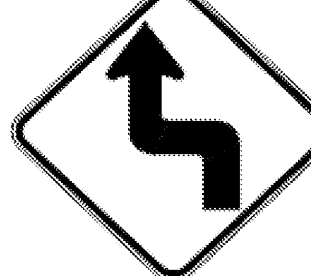

DIRECTION	MILEPOINT	LOCATION CODE (SHEET 2)	SIGN CODE	WIDTH (IN)	HEIGHT (IN)	SHEETING REMARKS	SIGN LEGEND	NEW SIGNS		EXISTING SIGNS				EXIST POST		NUMBER OF NEW POSTS	SQUARE STEEL (IN)			TUBULAR STEEL Ø (IN)				SIGN FRAME REQUIRED	REMARKS	SIGN DETAIL						
								"A"	"B"	RETAIN	SALVAGE FROM	SALVAGE TO	REMOVE	RETAIN	REMOVE		1.75	2.00	2.50	FOUNDATION	3.00	3.50	4.00			5.00	DETAIL IN SHS	DETAIL ON SHEET NUMBER	DETAIL ON STD SHEET NUMBER			
																	(LB / FT)				(LB / FT)											
WILLIAMSTOWN VT 14							FY-FLUORESCENT YELLOW FYG-FLUORESCENT YELLOW GREEN															"SHS"-STANDARD HIGHWAY SIGNS										
NB	5.650	C	VR-023B	30	30		\$500 FINE/TRASH																			GRAVEL PULLOUT						
NB	6.090	C	VR-017	24	30		LEGAL LOAD LIMIT 24000 LBS			1																	TH-89, HULBERT RD					
NB	6.100	D	R1-1	30	30		STOP			1																	TH-89, HULBERT RD					
NB	6.410	C	VR-017	24	30		LEGAL LOAD LIMIT 24000 LBS			1																	TH-75, FARNHAM RD					
NB	6.420	D	R1-1	30	30		STOP			1																	TH-75, FARNHAM RD					
NB	6.550	A	W11-10	30	30		TRUCK ENTERING SYMBOL			1																	ASSEMBLY HAS SOLAR FLASHING BEACON ATTACHED					
		A	S4-4M	24	10		WHEN FLASHING (YELLOW BKGRND)			1																						
NB	6.670	A	R2-5A	24	30		REDUCED SPEED AHEAD 																									
NB	6.695	A	W3-5	36	36		 	9.00								2		X									INSTALL 20 FT BEYOND PIKE DRIVEWAY, 10 FT SOUTH OF UTILITY POLE	X				
NB	6.725	A	W1-2MbR	30	30			6.25									2		X								INSTALL 200 FT +/- NORTH OF SPEED REDUCTION WARNING SIGN.			6		
		A	S3-1	30	30			6.25																		X						
NB	6.740	A	S3-1	30	30		SCHOOL BUS STOP AHEAD																									
NB	6.750	A	W2-2R	30	30		SIDE ROAD RIGHT																									
NB	6.805	A	R2-1	24	30																											
		A	R2-1	24	30			5.00											X													
SIGN SUMMARY SHEET							SHEET TOTALS	26.50	0.00	6	0	0	5	0	0	5	75															
VERMONT AGENCY OF TRANSPORTATION								SF	SF	EA	EA	EA	EA	EA	EA	EA	FT															
TOWN TOTALS							501.1	0.0	67.0	0.0	0.0	94	0.0	0.0	109	1635.0																





PROJECT NAME: **Hartford-East Montpelier VT14**
PROJECT NUMBER: **SIGN STPG(21)**
FILE NAME: **Williamstown.xls**
PROJECT MANAGER: **N. Avery**
DESIGNED BY: **A. Gamble**
WILLIAMSTOWN SHEET 8
PLOT DATE: **6/18/2009**
DRAWN BY: **T. Guazzoni**
CHECKED BY: **S. Menard**
SHEET **104** OF **162**



DIRECTION	MILEPOINT	LOCATION CODE (SHEET 2)	SIGN CODE	WIDTH (IN)	HEIGHT (IN)	SHEETING REMARKS	SIGN LEGEND FOR ALL POST LENGTHS AND INSTALLATION DATES SEE ORIGINAL RECORD PLANS	NEW SIGNS		EXISTING SIGNS				EXIST POST		NUMBER OF NEW POSTS	SQUARE STEEL (IN)			TUBULAR STEEL Ø (IN)				SIGN FRAME REQUIRED	REMARKS	SIGN DETAIL			
								"A"	"B"	RETAIN	SALVAGE FROM	SALVAGE TO	REMOVE	RETAIN	REMOVE		1.75	2.00	2.50	FOUNDATION	3.00	3.50	4.00			5.00	DETAIL IN SHS	DETAIL ON SHEET NUMBER	DETAIL ON STD SHEET NUMBER
																	(LB / FT)				(LB / FT)								
WILLIAMSTOWN VT 14							FY-FLUORESCENT YELLOW FYG-FLUORESCENT YELLOW GREEN															"SHS"-STANDARD HIGHWAY SIGNS							
SB	6.820	F	R2-1	24	30																								
		F	R2-1	24	30			5.00																X					
SB	6.700	G	W1-7	36	18	DOUBLE ARROW			1																				
SB	5.795	G	VR-017	24	30	LEGAL LOAD LIMIT 24000 LBS			1																				
SB	5.785	H	R1-1	30	30	STOP			1																				
SB	5.730	F	VW-059	30	30	HIDDEN DRIVE																							
		F	VW-054	30	30			6.25																		E-154			
SB	5.350	F	VW-054	30	30	HIDDEN DRIVE LEFT																							
SB	5.320	G	VR-017	24	30	LEGAL LOAD LIMIT 24000 LBS		5.00	1																				
SB	5.315	H	R1-1	30	30	STOP																							
SB	5.310	F	VW-054	30	30			6.25																		E-154			
SB	5.200	G	VR-017	24	30	LEGAL LOAD LIMIT 24000 LBS			1																				
SB	5.190	H	R1-1	30	30	STOP			1																				
SB	5.080	F	R2-5A	30	30	REDUCED SPEED AHEAD																							
SB	5.040	F	W1-5R	30	30	WINDING RD																							
SIGN SUMMARY SHEET							SHEET TOTALS	22.50 17.50	0.00	7	0	0	5	0	0	4 3	45						PROJECT NAME: Hartford-East Montpelier VT14 PROJECT NUMBER: SIGN STPG(21)						
VERMONT AGENCY OF TRANSPORTATION							TOWN TOTALS	501.1	0.0	67.0	0.0	0.0	94	0.0	0.0	109	1635.0						FILE NAME: Williamstown.xls PROJECT MANAGER: N. Avery DESIGNED BY: A. Gamble WILLIAMSTOWN SHEET 9	PLOT DATE: 6/18/2009 DRAWN BY: T. Guazzoni CHECKED BY: S. Menard SHEET 105 OF 162					

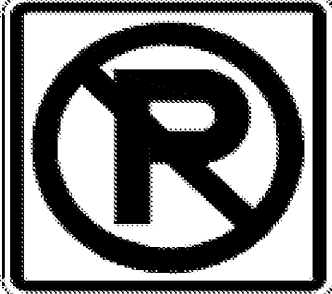

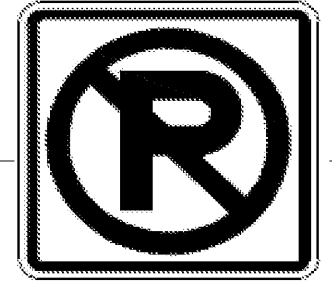



DIRECTION	MILEPOINT	LOCATION CODE (SHEET 2)	SIGN CODE	WIDTH (IN)	HEIGHT (IN)	SHEETING REMARKS	SIGN LEGEND	NEW SIGNS		EXISTING SIGNS				EXIST POST		NUMBER OF NEW POSTS	SQUARE STEEL (IN)			TUBULAR STEEL Ø (IN)				SIGN FRAME REQUIRED	REMARKS	SIGN DETAIL			
								"A"	"B"	RETAIN	SALVAGE FROM	SALVAGE TO	REMOVE	RETAIN	REMOVE		1.75	2.00	2.50	FOUNDATION	3.00	3.50	4.00			5.00	DETAIL IN SHS	DETAIL ON SHEET NUMBER	DETAIL ON STD SHEET NUMBER
																	(LB / FT)				(LB / FT)								
WILLIAMSTOWN VT 14							FY-FLUORESCENT YELLOW FYG-FLUORESCENT YELLOW GREEN															"SHS"-STANDARD HIGHWAY SIGNS							
			F	W13-1	18	18	30 MPH PLAQUE 																						
			F	W3-5	36	36		9.00										X						X					
SB	5.000		F	VD-018	30	18	WILLIAMSTOWN EAST BROOKFIELD 8	3.75										X						INSTALL 200 FT +/- SOUTH OF SPEED REDUCTION WARNING SIGN			E-128B		
SB	4.960		F	VW-054	30	30	  																						
			F	W1-3L	30	30																							
			F	W13-1	18	18																							
			F	VW-054	30	30		6.25											X							E-154			
			F	W1-3L	30	30		6.25																X					
			F	W13-1	18	18		2.25																X	INSTALL PLAQUE ON LEFT POST				
SB	4.920		F	R2-1	24	30																							
			F	R2-1	30	36		7.50											X						6				
SB	4.810		F	R2-1	24	30																							
			F	R2-1	24	30		5.00											X					X					
SB	4.760		F	W1-4R	30	30	REVERSE CURVE																						
			F	W13-1	18	18	30 MPH PLAQUE																						
SIGN SUMMARY SHEET							SHEET TOTALS	40.00	0.00	0	0	0	8	0	0	7	105												
VERMONT AGENCY OF TRANSPORTATION								SF	SF	EA	EA	EA	EA	EA	EA	EA	EA	FT											
							TOWN TOTALS	501.1	0.0	67.0	0.0	0.0	94	0.0	0.0	109	1635.0												
															PROJECT NAME:	Hartford-East Montpelier VT14													
															PROJECT NUMBER:	SIGN STPG(21)													
															FILE NAME:	Williamstown.xls					PLOT DATE:	6/18/2009							
															PROJECT MANAGER:	N. Avery					DRAWN BY:	T. Guazzoni							
															DESIGNED BY:	A. Gamble					CHECKED BY:	S. Menard							
															WILLIAMSTOWN SHEET 10						SHEET	106 OF 162							



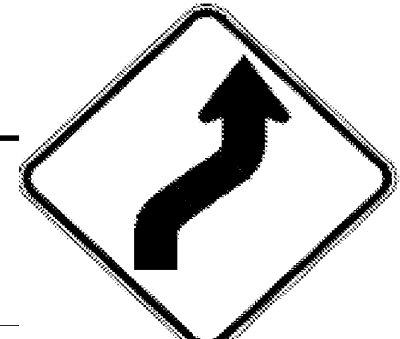

DIRECTION	MILEPOINT	LOCATION CODE (SHEET 2)	SIGN CODE	WIDTH (IN)	HEIGHT (IN)	SHEETING REMARKS	SIGN LEGEND	NEW SIGNS		EXISTING SIGNS				EXIST POST		NUMBER OF NEW POSTS	SQUARE STEEL (IN)			TUBULAR STEEL Ø (IN)				SIGN FRAME REQUIRED	REMARKS	SIGN DETAIL			
								"A"	"B"	RETAIN	SALVAGE FROM	SALVAGE TO	REMOVE	RETAIN	REMOVE		1.75	2.00	2.50	FOUNDATION	3.00	3.50	4.00			5.00	DETAIL IN SHS	DETAIL ON SHEET NUMBER	DETAIL ON STD SHEET NUMBER
																	(LB / FT)				(LB / FT)								
WILLIAMSTOWN VT 14							FY-FLUORESCENT YELLOW FYG-FLUORESCENT YELLOW GREEN															"SHS"-STANDARD HIGHWAY SIGNS							
SB	4.710	G	VR-017	24	30		LEGAL LOAD LIMIT 24,000 LBS			1					X									TH-78, ELM ST					
SB	4.705	H	R1-1	30	30		STOP			1					X									TH-78, ELM ST					
SB	4.700	A	W11-2	30	30		PEDESTRIAN									1													
			W1-4R	30	30			6.25																		X			
SB	4.610	F	M2-1	21	15		JCT																						
			M1-5	24	24		VERMONT 64																						
SB	4.595	F	W11-2	30	30	FYG		6.25																INSTALL 75 FT +/- SOUTH OF JCT VT 64 (TO BE REMOVED)	X				
SB	4.590	F	D1-1	54	7.5		<--- GRANITEVILLE																						
SB	4.570	G	VR-017	24	30		LEGAL LOAD LIMIT 24000			1					X									TH-24, CONSTRUCTION HILL RD					
SB	4.580	H	R1-1	30	30		STOP			1					X									TH-24, CONSTRUCTION HILL RD					
SB	4.575	F	M2-1	21	15		JCT	2.19																					
			M1-5	24	24		VERMONT 64	4.00																		X		E-136B	
SB	4.565	F	W11-8	30	30																								
			W11-8	30	30			6.25																		X			
SB	4.520	F	D1-1A	72	10		UP ARROW E BROOKFIELD 8			1					X									RETAIN - ASSEMBLY TO BE REPLACED BY WILLIAMSTOWN BRS0204(4)					
SIGN SUMMARY SHEET							SHEET TOTALS	24.94	0.00	5	0	0	5	0	0	4	60								PROJECT NAME: Hartford-East Montpelier VT14				
								SF	SF	EA	EA	EA	EA	EA	EA	EA	FT									PROJECT NUMBER: SIGN STPG(21)			
VERMONT AGENCY OF TRANSPORTATION							TOWN TOTALS	501.1	0.0	67.0	0.0	0.0	94	0.0	0.0	109	1635.0									FILE NAME: Williamstown.xls	PLOT DATE: 6/18/2009		
																									PROJECT MANAGER: N. Avery	DRAWN BY: T. Guazzoni			
																									DESIGNED BY: A. Gamble	CHECKED BY: S. Menard			
																									WILLIAMSTOWN SHEET 11	SHEET 107 OF 162			

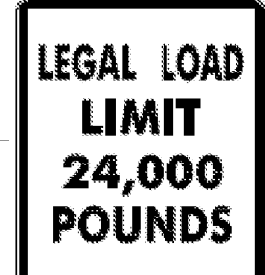

DIRECTION	MILEPOINT	LOCATION CODE (SHEET 2)	SIGN CODE	WIDTH (IN)	HEIGHT (IN)	SHEETING REMARKS	SIGN LEGEND	NEW SIGNS		EXISTING SIGNS				EXIST POST		NUMBER OF NEW POSTS	SQUARE STEEL (IN)			TUBULAR STEEL Ø (IN)				SIGN FRAME REQUIRED	REMARKS	SIGN DETAIL			
								"A"	"B"	RETAIN	SALVAGE FROM	SALVAGE TO	REMOVE	RETAIN	REMOVE		1.75	2.00	2.50	FOUNDATION						DETAIL IN SHS	DETAIL ON SHEET NUMBER	DETAIL ON STD SHEET NUMBER	
																	(LB / FT)			3.00	3.50	4.00	5.00						(LB / FT)
WILLIAMSTOWN VT 14							FY-FLUORESCENT YELLOW FYG-FLUORESCENT YELLOW GREEN														"SHS"-STANDARD HIGHWAY SIGNS								
			F	M3-3S	24	12	SOUTH			1																			
			F	M1-5	24	24	VT 14			1																			
			F	M6-3S	21	15	UP ARROW			1																			
			F	M4-5I	24	12	TO			1																			
			F	M1-1	24	24	I-89			1																			
			F	M6-1	21	15	RIGHT ARROW			1																			
			F	M3-4S	24	12	WEST			1																			
			F	M1-5	24	24	VT 64			1																			
			F	M6-1S	21	15	RIGHT ARROW			1																			
SB	4.510		F	VR-345	24	30	NO PARKING HERE TO CORNER					1		X															
			F	R8-3A	24	24			4.00						1		X						X						
			F	R8-3cM	24	18			3.00															5					
SB	4.470		F	R2-1	24	30						1		X															
			F	R2-1	24	30			5.00						1		X						X						
SB	4.450		F	M3-3	24	12						1		X															
SIGN SUMMARY SHEET							SHEET TOTALS	12.00	0.00	9	0	0	3	0	0	2	30												
							SF	SF	EA	EA	EA	EA	EA	EA	EA	EA	FT												
VERMONT AGENCY OF TRANSPORTATION							TOWN TOTALS	501.1	0.0	67.0	0.0	0.0	94	0.0	0.0	109	1635.0												
																		PROJECT NAME:	Hartford-East Montpelier VT14										
																		PROJECT NUMBER:	SIGN STPG(21)										
																		FILE NAME:	Williamstown.xls					PLOT DATE:	6/18/2009				
																		PROJECT MANAGER:	N. Avery					DRAWN BY:	T. Guazzoni				
																		DESIGNED BY:	A. Gamble					CHECKED BY:	S. Menard				
																		WILLIAMSTOWN SHEET	12					SHEET	108 OF 162				

DIRECTION	MILEPOINT	LOCATION CODE (SHEET 2)	SIGN CODE	WIDTH (IN)	HEIGHT (IN)	SHEETING REMARKS	SIGN LEGEND	NEW SIGNS		EXISTING SIGNS				EXIST POST		NUMBER OF NEW POSTS	SQUARE STEEL (IN)			TUBULAR STEEL Ø (IN)				SIGN FRAME REQUIRED	REMARKS	SIGN DETAIL		
								"A"	"B"	RETAIN	SALVAGE FROM	SALVAGE TO	REMOVE	RETAIN	REMOVE		1.75	2.00	2.50	3.00	3.50	4.00	5.00			DETAIL IN SHS	DETAIL ON SHEET NUMBER	DETAIL ON STD SHEET NUMBER
																	(LB / FT)			(LB / FT)								
WILLIAMSTOWN VT 14							FY-FLUORESCENT YELLOW FYG-FLUORESCENT YELLOW GREEN															"SHS"-STANDARD HIGHWAY SIGNS						
			F M1-5	24	24								1															
			F M3-3	24	12				2.00								1	X									X	
			F M1-5	24	24				4.00																		E-136B	
SB	4.430	G	VR-017	24	30		LEGAL LOAD LIMIT 24000 LBS			1																TH-73, GARDEN ST		
SB	4.420	H	R1-1	30	30		STOP			1																TH-73, GARDEN ST		
SB	4.420	F	R8-3A	24	24		 						1															
			F VR-644P	24	12																							
			F R8-3A	24	24				4.00							1	X										X	
			F VR-644P	24	12				2.00																		RED ON WHITE SHEETING 6	
SB	4.400	F	R8-3A	24	24		 						1															
			F M4-6	24	12																							
			F R8-3A	24	24				4.00							1	X										X	
			F M4-6	24	12				2.00																		RED ON WHITE SHEETING X	
SB	4.360	F	R2-1	24	30								1															
			F R2-1	24	30				5.00							1	X										X	
SIGN SUMMARY SHEET							SHEET TOTALS	23.00	0.00	2	0	0	6	0	0	4	60								PROJECT NAME: Hartford-East Montpelier VT14 PROJECT NUMBER: SIGN STPG(21)			
VERMONT AGENCY OF TRANSPORTATION							TOWN TOTALS	501.1	0.0	67.0	0.0	0.0	94	0.0	0.0	109	1635.0								FILE NAME: Williamstown.xls PROJECT MANAGER: N. Avery DESIGNED BY: A. Gamble WILLIAMSTOWN SHEET 13	PLOT DATE: 6/18/2009 DRAWN BY: T. Guazzoni CHECKED BY: S. Menard SHEET 109 OF 162		

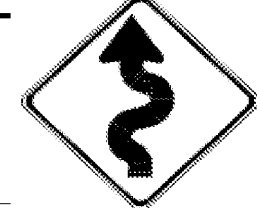
DIRECTION	MILEPOINT	LOCATION CODE (SHEET 2)	SIGN CODE	WIDTH (IN)	HEIGHT (IN)	SHEETING REMARKS	SIGN LEGEND	NEW SIGNS		EXISTING SIGNS				EXIST POST		NUMBER OF NEW POSTS	SQUARE STEEL (IN)			TUBULAR STEEL Ø (IN)				SIGN FRAME REQUIRED	REMARKS	SIGN DETAIL			
								"A"	"B"	RETAIN	SALVAGE FROM	SALVAGE TO	REMOVE	RETAIN	REMOVE		1.75	2.00	2.50	FOUNDATION	3.00	3.50	4.00			5.00	DETAIL IN SHS	DETAIL ON SHEET NUMBER	DETAIL ON STD SHEET NUMBER
																	(LB / FT)				(LB / FT)								
WILLIAMSTOWN VT 14							FY-FLUORESCENT YELLOW FYG-FLUORESCENT YELLOW GREEN															"SHS"-STANDARD HIGHWAY SIGNS							
SB	4.305	G	VR-017	24	30		LEGAL LOAD LIMIT 24000			1				X										TH-39, PLEASANT ST					
SB	4.295	H	R1-1	30	30		STOP			1				X										TH-39, PLEASANT ST					
SB	4.240	F	W11-6H	30	30								1		X														
		F	W11-6H	30	30			6.25								1	X							INSTALL IN CLOSED POSITION			E-153		
SB	4.195	G	VR-017	24	30		LEGAL LOAD LIMIT 24000			1				X										TH-40, SPIDER WEB FARM RD					
SB	4.190	H	R1-1	30	30		STOP			1				X										TH-40, SPIDER WEB FARM RD					
SB	4.150	F	R2-1	24	30								1		X														
		F	R2-1	24	30			5.00								1	X							INSTALL BEHIND SOUTH END OF GUARDRAIL	X				
SB	4.110	F	W11-2YG	30	30		PEDESTRIAN			1				X															
SB	4.110	F	W16-4YG	24	18		NEXT 700 FEET			1																			
SB	4.040	F	R2-1	24	30								1		X														
		F	R2-1	24	30			5.00								1	X									X			
SB	3.990	A	VW-202	30	30		TRUCKS ENTERING (TEXT)							1		X													
SB	3.915	G	VR-017	24	30		LEGAL LOAD LIMIT 24000 LBS			1				X											TH-100, INDUSTRY ST				
SB	3.910	H	R1-1	30	30		STOP			1				X											TH-100, INDUSTRY ST				
SIGN SUMMARY SHEET							SHEET TOTALS	16.25	0.00	8	0	0	4	0	0	3	45							PROJECT NAME: Hartford-East Montpelier VT14					
							SF	SF	EA	EA	EA	EA	EA	EA	EA	EA	FT							PROJECT NUMBER: SIGN STPG(21)					
VERMONT AGENCY OF TRANSPORTATION							TOWN TOTALS	501.1	0.0	67.0	0.0	0.0	94	0.0	0.0	109	1635.0							FILE NAME: Williamstown.xls					
																							PLOT DATE: 6/18/2009						
																							DESIGNED BY: A. Gamble						
																							CHECKED BY: S. Menard						
																							WILLIAMSTOWN SHEET 14						
																							SHEET 110 OF 162						

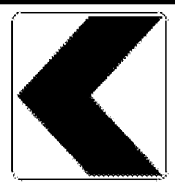
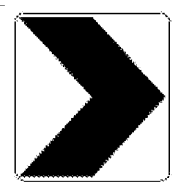
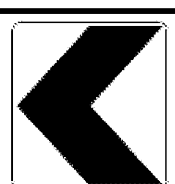
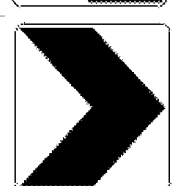
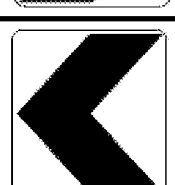
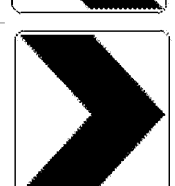

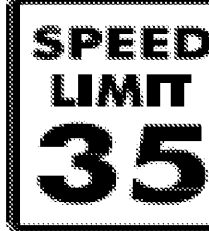

DIRECTION	MILEPOINT	LOCATION CODE (SHEET 2)	SIGN CODE	WIDTH (IN)	HEIGHT (IN)	SHEETING REMARKS	SIGN LEGEND	NEW SIGNS		EXISTING SIGNS				EXIST POST		NUMBER OF NEW POSTS	SQUARE STEEL (IN)			TUBULAR STEEL Ø (IN)				SIGN FRAME REQUIRED	REMARKS	SIGN DETAIL				
								"A"	"B"	RETAIN	SALVAGE FROM	SALVAGE TO	REMOVE	RETAIN	REMOVE		1.75	2.00	2.50	3.00	3.50	4.00	5.00			DETAIL IN SHS	DETAIL ON SHEET NUMBER	DETAIL ON STD SHEET NUMBER		
																	(LB / FT)			(LB / FT)										
WILLIAMSTOWN VT 14							FY-FLUORESCENT YELLOW FYG-FLUORESCENT YELLOW GREEN															"SHS"-STANDARD HIGHWAY SIGNS								
SB	2.050	G	VR-017	24	24																									
		G	VR-017	24	30			5.00																		TH-93, TRIPP RD			E-141	
SB	2.045	H	R1-1	24	24																									
		H	R1-1	30	30			6.25																		TH-93, TRIPP RD	X			
SB	1.990	F	W1-4R	30	30			6.25																		INSTALL 300 FT +/- SOUTH OF TRIPP RD	X			
		F	W13-1	18	18			2.25																			X			
SB	1.890 TO 1.690	F		6	8		20 WHITE DELINEATORS	6.67																		INSTALL B-B AT 100' SPACING, STARTING 500 FT SOUTH OF REV CURVE SIGN			5	
SB	1.270	F	S3-1	30	30																									
		F	S3-1	30	30			6.25																			X			
SB	1.180	F	W1-2L	30	30		CURVE LEFT																							
		F	W13-1	18	18		40 MPH PLAQUE																							
SB	1.155	G	VR-017	24	24																									
		G	VR-017	24	30			5.00																		TH-93, TRIPP RD			E-141	
SB	1.150	H	R1-1	24	24																									
		H	R1-1	30	30			6.25																		TH-93, TRIPP RD	X			
SIGN SUMMARY SHEET							SHEET TOTALS	43.92	0.00	0	0	0	67	0	0	16	240													
VERMONT AGENCY OF TRANSPORTATION							TOWN TOTALS	501.1	0.0	67.0	0.0	0.0	94	0.0	0.0	109	1635.0													
PROJECT NAME: Hartford-East Montpelier VT14																						PROJECT NUMBER: SIGN STPG(21)								
FILE NAME: Williamstown.xls															PLOT DATE: 6/18/2009			DRAWN BY: T. Guazzoni												
PROJECT MANAGER: N. Avery															DESIGNED BY: A. Gamble			CHECKED BY: S. Menard												
WILLIAMSTOWN SHEET 16																						SHEET 112 OF 162								



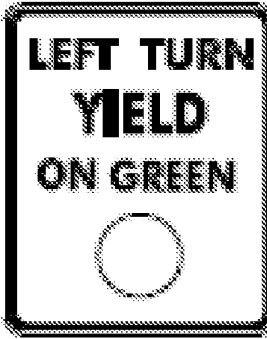
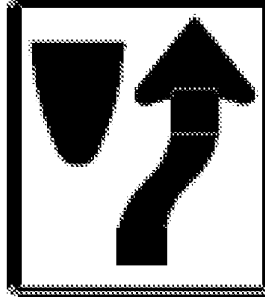
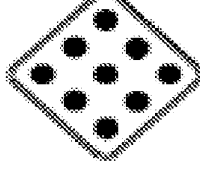

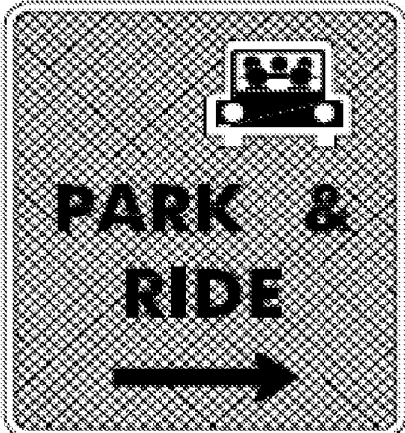
DIRECTION	MILEPOINT	LOCATION CODE (SHEET 2)	SIGN CODE	WIDTH (IN)	HEIGHT (IN)	SHEETING REMARKS	SIGN LEGEND	NEW SIGNS		EXISTING SIGNS				EXIST POST		NUMBER OF NEW POSTS	SQUARE STEEL (IN)			TUBULAR STEEL Ø (IN)				SIGN FRAME REQUIRED	REMARKS	SIGN DETAIL			
								"A"	"B"	RETAIN	SALVAGE FROM	SALVAGE TO	REMOVE	RETAIN	REMOVE		1.75	2.00	2.50	FOUNDATION	3.00	3.50	4.00			5.00	DETAIL IN SHS	DETAIL ON SHEET NUMBER	DETAIL ON STD SHEET NUMBER
																	(LB / FT)				(LB / FT)								
WILLIAMSTOWN VT 14							FY-FLUORESCENT YELLOW FYG-FLUORESCENT YELLOW GREEN															"SHS"-STANDARD HIGHWAY SIGNS							
SB	1.090	F	W1-2L	30	30	FY		6.25							1	X							INSTALL AT SOUTH END OF GRAVEL PULL-OFF	X					
		F	W13-1	18	18	FY			2.25																X				
SB	0.620	F	W1-5L	30	30		WINDING RD																						
		F	W13-1	18	18		40 MPH PLAQUE																						
SB	0.540	F	W1-5L	30	30	FY	 	6.25								1	X							INSTALL ON SOUTH SIDE OF CULVERT BEHIND GUARDRAIL	X				
		F	W7-3A	24	18	FY			3.00																	X			
SB	0.490	F	W1-8	24	30	FY	 	5.00								1	X							INSTALL 300 FT +/- SOUTH OF CULVERT HEADWALL	X				
		E	W1-8	24	30	FY			5.00								1	X							INSTALL ON SEPARATE POST 5 FT SOUTH OF SB FACING SIGN	X			
SB	0.470	F	W1-6	60	48		LEFT ARROW																						
SB	0.450	F	W1-8	24	30	FY	 	5.00								1	X							INSTALL 100 FT +/- SOUTH OF LEFT ARROW (TO BE REMOVED)	X				
		E	W1-8	24	30	FY			5.00								1	X							INSTALL ON SEPARATE POST 5 FT SOUTH OF SB FACING SIGN	X			
SB	0.410	F	W1-8	24	30	FY	 	5.00								1	X							INSTALL 50 FT +/- NORTH OF NB FACING RIGHT ARROW (TO BE REMOVED)	X				
		E	W1-8	24	30	FY			5.00								1	X							INSTALL ON SEPARATE POST 5 FT SOUTH OF SB FACING SIGN	X			
SB	0.400	E	W1-6	60	48		RIGHT ARROW (FACING NB)																						
SB	0.380	F	W1-8	24	30	FY		5.00								1	X						INSTALL 100 FT +/- SOUTH OF NB FACING RIGHT ARROW (TO BE REMOVED)	X					
SIGN SUMMARY SHEET							SHEET TOTALS	52.75	0.00	0	0	0	4	0	0	9	135					PROJECT NAME: Hartford-East Montpelier VT14							
							SF	SF	EA	EA	EA	EA	EA	EA	EA	EA	FT					PROJECT NUMBER: SIGN STPG(21)							
VERMONT AGENCY OF TRANSPORTATION							TOWN TOTALS	501.1	0.0	67.0	0.0	0.0	94	0.0	0.0	109	1635.0					FILE NAME: Williamstown.xls	PLOT DATE: 6/18/2009						
																					PROJECT MANAGER: N. Avery	DRAWN BY: T. Guazzoni							
																					DESIGNED BY: A. Gamble	CHECKED BY: S. Menard							
																					WILLIAMSTOWN SHEET 17	SHEET 113 OF 162							

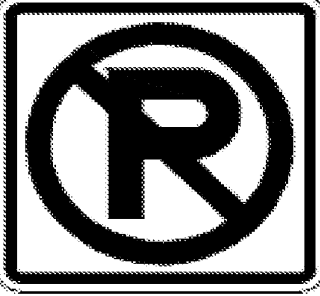



DIRECTION	MILEPOINT	LOCATION CODE (SHEET 2)	SIGN CODE	WIDTH (IN)	HEIGHT (IN)	SHEETING REMARKS	SIGN LEGEND	NEW SIGNS		EXISTING SIGNS				EXIST POST		NUMBER OF NEW POSTS	SQUARE STEEL (IN)			TUBULAR STEEL Ø (IN)				SIGN FRAME REQUIRED	REMARKS	SIGN DETAIL									
								"A"	"B"	RETAIN	SALVAGE FROM	SALVAGE TO	REMOVE	RETAIN	REMOVE		1.75	2.00	2.50	FOUNDATION	3.00	3.50	4.00			5.00	DETAIL IN SHS	DETAIL ON SHEET NUMBER	DETAIL ON STD SHEET NUMBER						
																	(LB / FT)				(LB / FT)														
BARRE TOWN VT 14							FY-FLUORESCENT YELLOW FYG-FLUORESCENT YELLOW GREEN															"SHS"-STANDARD HIGHWAY SIGNS													
NB	0.875	C	VR-017	24	24		LEGAL LOAD LIMIT 24000 LBS			1														TH-60, HOLDEN RD											
NB	0.880	D	R1-1	24	24		STOP			1														TH-60, HOLDEN RD											
NB	1.020	A	R2-1	24	30							1																							
		A	R2-1	24	30				5.00						1		X								X										
NB	1.270	A	R2-5A	24	30		REDUCED SPEED AHEAD						1																						
		A	W3-5	36	36																														
		A	W3-5	36	36				9.00						2		X								X										
NB	1.380	A	VD-062A	72	16		BUSINESS SIGN			1																									
		A	VD-062A	72	16					1																									
NB	1.415	A	R2-1	30	36																														
		A	R2-1	30	36				7.50						1		X								INSTALL 80 FT SOUTH OF EXISTING, AT END OF GRASS ISLAND										
NB	1.450	A	R2-1	24	30		SPEED LIMIT 35						1																						
NB	1.500	C	VR-017	24	30		LEGAL LOAD LIMIT 24000 LBS			1														TH-214, DON CAMP RD											
NB	1.505	D	R1-1	30	30		STOP			1														TH-214, DON CAMP RD											
NB	1.550	A	W3-3	36	36		SIGNAL AHEAD			1																									
NB	1.560	A	VD-066	24	24		GAS/FOOD			1																									
NB	1.585	A	M2-1	21	15								1																						
SIGN SUMMARY SHEET							SHEET TOTALS	21.50	0.00	8	0	0	4	0	0	4	60																		
							SF SF EA EA EA EA EA EA EA EA																												
VERMONT AGENCY OF TRANSPORTATION							TOWN TOTALS	583.8	0.0	48.0	9.0	9.0	115	0.0	0.0	89	1335.0																		
																		PROJECT NAME:	Hartford-East Montpelier VT14																
																		PROJECT NUMBER:	STPG SIGN(21)																
																		FILE NAME:	Barre Town.xls					PLOT DATE:	6/18/2009										
																		PROJECT MANAGER:	N. Avery					DRAWN BY:	T. Guazzoni										
																		DESIGNED BY:	A. Gamble					CHECKED BY:	S. Menard										
																		BARRE TOWN SHEET 2						SHEET	116					OF	162				





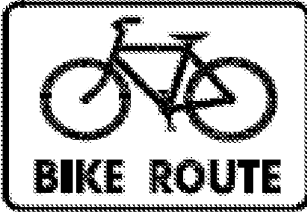
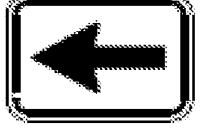
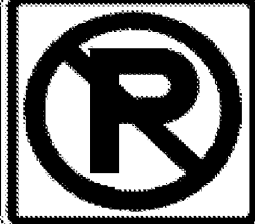

DIRECTION	MILEPOINT	LOCATION CODE (SHEET 2)	SIGN CODE	WIDTH (IN)	HEIGHT (IN)	SHEETING REMARKS	SIGN LEGEND	NEW SIGNS		EXISTING SIGNS				EXIST POST		NUMBER OF NEW POSTS	SQUARE STEEL (IN)			TUBULAR STEEL Ø (IN)				SIGN FRAME REQUIRED	REMARKS	SIGN DETAIL		
								"A"	"B"	RETAIN	SALVAGE FROM	SALVAGE TO	REMOVE	RETAIN	REMOVE		1.75	2.00	2.50	3.00	3.50	4.00	5.00			DETAIL IN SHS	DETAIL ON SHEET NUMBER	DETAIL ON STD SHEET NUMBER
																	(LB / FT)			(LB / FT)								
BARRE TOWN VT 14							FY-FLUORESCENT YELLOW FYG-FLUORESCENT YELLOW GREEN															"SHS"-STANDARD HIGHWAY SIGNS						
			A	M1-5A	24	24							1															
			A	M2-1	21	15		2.19							1	X										X		
			A	M1-5	24	24		4.00																		E-136B		
NB	1.635		A	VR-922L	36	30	LEFT ONLY/THRU-RIGHT				1				X													
NB	1.640		J	R4-7	24	30	KEEP RIGHT SYMBOL				1				X													
			J	OM1-1	12	12	YELLOW CLUSTER				1																	
			K	R3-4	24	24	NO U-TURN (FACING SB)				1																	
			K	OM1-1	12	12	YELLOW CLUSTER (FACING SB)				1																	
NB	1.655		A	D1-1A	54	7.5	UP ARROW BARRE 2						1		X													
			A	D1-1A	54	7.5	UP ARROW E MONTPELIER 5						1															
			A	D1-1A	54	7.5	GRANITEVILLE 3 RIGHT ARROW						1															
			A	M3-4	24	12	WEST						1															
			A	M1-5	24	24	VT 63						1															
			A	M6-1	21	15	LEFT ARROW						1															
			A	M4-5	24	12	TO						1															
SIGN SUMMARY SHEET							SHEET TOTALS	6.19	0.00	5	0	0	8	0	0	1	15							PROJECT NAME: Hartford-East Montpelier VT14				
							SF SF			EA	EA	EA	EA	EA	EA	EA	FT							PROJECT NUMBER: STPG SIGN(21)				
VERMONT AGENCY OF TRANSPORTATION							TOWN TOTALS	583.8	0.0	48.0	9.0	9.0	115	0.0	0.0	89	1335.0							FILE NAME: Barre Town.xls				
																								PLOT DATE: 6/18/2009				
																									DRAWN BY: T. Guazzoni			
																									DESIGNED BY: A. Gamble			
																									CHECKED BY: S. Menard			
																									SHEET 117 OF 162			





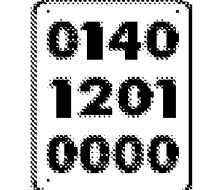
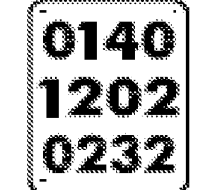

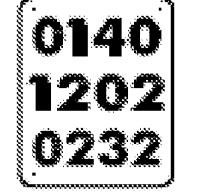
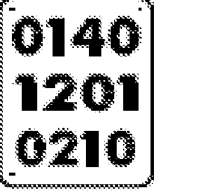
DIRECTION	MILEPOINT	LOCATION CODE (SHEET 2)	SIGN CODE	WIDTH (IN)	HEIGHT (IN)	SHEETING REMARKS	SIGN LEGEND FOR ALL POST LENGTHS AND INSTALLATION DATES SEE ORIGINAL RECORD PLANS	NEW SIGNS		EXISTING SIGNS				EXIST POST		NUMBER OF NEW POSTS	SQUARE STEEL (IN)			TUBULAR STEEL Ø (IN)				SIGN FRAME REQUIRED	REMARKS	SIGN DETAIL																			
								"A"	"B"	RETAIN	SALVAGE FROM	SALVAGE TO	REMOVE	RETAIN	REMOVE		1.75	2.00	2.50	FOUNDATION	3.00	3.50	4.00			5.00	DETAIL IN SHS	DETAIL ON SHEET NUMBER	DETAIL ON STD SHEET NUMBER																
																	(LB / FT)				(LB / FT)																								
BARRE TOWN VT 14							FY-FLUORESCENT YELLOW FYG-FLUORESCENT YELLOW GREEN															"SHS"-STANDARD HIGHWAY SIGNS																							
			A	M1-5	24	24		4.00																				E-136B																	
			A	M6-3	21	15		2.19																																					
NB	1.660	L	R6-1R	36	12		ONE WAY (FACING EAST IN MEDIAN)			1																																			
NB	1.670	K	R4-7	24	30		KEEP RIGHT SYMBOL (MEDIAN FACING SB)			1																																			
			K	OM1-1	12	12	YELLOW CLUSTER (MEDIAN FACING SB)			1																																			
NB	1.680	C	VR-017	24	30		LEGAL LOAD LIMIT 24000 LBS			1																		TH-4, MIDDLE RD																	
NB	1.685	M	R10-12	24	30								1																																
			M	R10-12	24	30			5.00																				INSTALL ON SPAN WIRE NEXT TO LEFT TURN SIGNAL																
NB	1.687	C	R4-7	24	30		 																																						
			C	OM1-1	12	12																																							
			C	R4-7	24	30			5.00			4	4				1			X									INSTALL ON MIDDLE RD MEDIAN FACING EB (VT 63)																
			C	OM1-1	12	12		1.00																																					
NB	1.705	A	M3-1	24	12		NORTH																																						
			A	M1-5	24	24	VT 14																																						
			A	M4-5	24	12	TO																																						
SIGN SUMMARY SHEET							SHEET TOTALS	17.19	0.00	4	4	4	7	0	0	2		15																											
VERMONT AGENCY OF TRANSPORTATION								SF	SF	EA	EA	EA	EA	EA	EA	EA		FT																											
							TOWN TOTALS	583.8	0.0	48.0	9.0	9.0	115	0.0	0.0	89		1335.0																											
																						PROJECT NAME:	Hartford-East Montpelier VT14					PROJECT NUMBER:	STPG SIGN(21)					FILE NAME:	Barre Town.xls					PLOT DATE:	6/18/2009				
																						DESIGNED BY:	A. Gamble					BARRE TOWN SHEET	5					PROJECT MANAGER:	N. Avery					DRAWN BY:	T. Guazzoni				
																						CHECKED BY:	S. Menard											SHEET	119					OF	162				







DIRECTION	MILEPOINT	LOCATION CODE (SHEET 2)	SIGN CODE	WIDTH (IN)	HEIGHT (IN)	SHEETING REMARKS	SIGN LEGEND FOR ALL POST LENGTHS AND INSTALLATION DATES SEE ORIGINAL RECORD PLANS	NEW SIGNS		EXISTING SIGNS				EXIST POST		NUMBER OF NEW POSTS	SQUARE STEEL (IN) (LB / FT)			TUBULAR STEEL Ø (IN) (LB / FT)				SIGN FRAME REQUIRED	REMARKS	SIGN DETAIL							
								"A"	"B"	RETAIN	SALVAGE FROM	SALVAGE TO	REMOVE	RETAIN	REMOVE		1.75	2.00	2.50	FOUNDATION	3.00	3.50	4.00			5.00	DETAIL IN SHS	DETAIL ON SHEET NUMBER	DETAIL ON STD SHEET NUMBER				
																														1.88	2.42	3.35	7.60
BARRE TOWN VT 14							FY-FLUORESCENT YELLOW FYG-FLUORESCENT YELLOW GREEN															"SHS"-STANDARD HIGHWAY SIGNS											
		A	M1-4	30	24	US 302																											
		A	M3-1	24	12																			2.00				#1A	GREEN ON WHITE SHEETING	X	7		
		A	M1-5	24	24																			4.00								E-136B	
		A	M4-5	24	12																			2.00								X	
		A	M1-4	30	24																			5.00								X	
NB	1.760	A	D4-2	30	36																												
		A	VD-365	30	6	1-800-685-RIDE																											
		A	D4-2	30	36																			7.50								X	
NB	1.770	A	VD-062B	72	16	BUSINESS SIGN																											
																									5.00								
NB	1.785	A	R2-1	24	30																												
																																	
																																	
NB	1.820	C	VR-017	24	24																												
SIGN SUMMARY SHEET							SHEET TOTALS		31.50	0.00	1	0	0	6	0	0	4	60						PROJECT NAME: Hartford-East Montpelier VT14									
VERMONT AGENCY OF TRANSPORTATION							SF	SF	EA	EA	EA	EA	EA	EA	EA	EA	EA	EA	EA	FT						PROJECT NUMBER: STPG SIGN(21)							
							TOWN TOTALS		583.8	0.0	48.0	9.0	9.0	115	0.0	0.0	89	1335.0						FILE NAME: Barre Town.xls PLOT DATE: 6/18/2009									
																									PROJECT MANAGER: N. Avery DRAWN BY: T. Guazzoni								
																									DESIGNED BY: A. Gamble CHECKED BY: S. Menard								
																									BARRE TOWN SHEET 6 SHEET 120 OF 162								



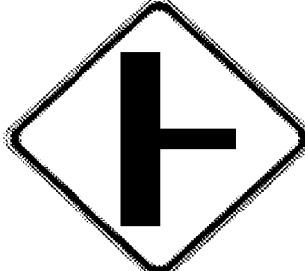



DIRECTION	MILEPOINT	LOCATION CODE (SHEET 2)	SIGN CODE	WIDTH (IN)	HEIGHT (IN)	SHEETING REMARKS	SIGN LEGEND FOR ALL POST LENGTHS AND INSTALLATION DATES SEE ORIGINAL RECORD PLANS	NEW SIGNS		EXISTING SIGNS				EXIST POST		NUMBER OF NEW POSTS	SQUARE STEEL (IN) (LB / FT)			TUBULAR STEEL Ø (IN) (LB / FT)				SIGN FRAME REQUIRED	REMARKS	SIGN DETAIL			
								"A"	"B"	RETAIN	SALVAGE FROM	SALVAGE TO	REMOVE	RETAIN	REMOVE		FOUNDATION	1.75	2.00	2.50	3.00	3.50	4.00			5.00	DETAIL IN SHS	DETAIL ON SHEET NUMBER	DETAIL ON STD SHEET NUMBER
																		1.88	2.42	3.35	7.60	9.00	10.80			14.60			
BARRE TOWN VT 14							FY-FLUORESCENT YELLOW FYG-FLUORESCENT YELLOW GREEN															"SHS"-STANDARD HIGHWAY SIGNS							
		C	VR-017	24	30			5.00								1		X					TH-108, WILSON ST			E-141			
NB	1.825	D	R1-1	24	24																								
		D	R1-1	30	30			6.25																TH-108, WILSON ST	X				
NB	1.845	C	VR-017	24	24																								
		C	N/A				TOWN PARKING REGULATION																						
		C	VR-017	24	30			5.00																TH-109, SEAGER LN RE-INSTALL TOWN'S PARKING REGULATION SIGN BELOW LEGAL LOAD SIGN			E-141		
		C	N/A																										
NB	1.850	D	R1-1	24	24																								
		A	D-3				SEAGER LN																						
		A	D-3				SEAGER LN																						
		D	R1-1	30	30			6.25																TH-109, SEAGER LN	X				
NB	1.890	A	W2-1M	30	30		INTERSECTION																						
NB	1.890	A	W16-2	24	18		500 FEET																						
NB	1.915	A	R8-3A	24	24																								
		A	R8-3A	24	24			4.00																		X			
SIGN SUMMARY SHEET							SHEET TOTALS	26.50	0.00	2	2 3	4 2	4	0	0	5	75							PROJECT NAME: Hartford-East Montpelier VT14 PROJECT NUMBER: STPG SIGN(21)					
VERMONT AGENCY OF TRANSPORTATION							TOWN TOTALS	583.8	0.0	48.0	9.0	9.0	115	0.0	0.0	89	1335.0							FILE NAME: Barre Town.xls PROJECT MANAGER: N. Avery DESIGNED BY: A. Gamble BARRE TOWN SHEET 7	PLOT DATE: 6/18/2009 DRAWN BY: T. Guazzoni CHECKED BY: S. Menard SHEET 121 OF 162				





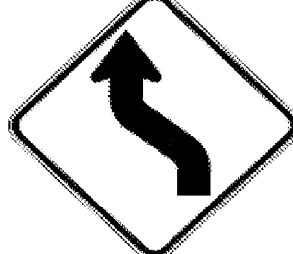

DIRECTION	MILEPOINT	LOCATION CODE (SHEET 2)	SIGN CODE	WIDTH (IN)	HEIGHT (IN)	SHEETING REMARKS	SIGN LEGEND FOR ALL POST LENGTHS AND INSTALLATION DATES SEE ORIGINAL RECORD PLANS	NEW SIGNS		EXISTING SIGNS				EXIST POST		NUMBER OF NEW POSTS	SQUARE STEEL (IN)			TUBULAR STEEL Ø (IN)				SIGN FRAME REQUIRED	REMARKS	SIGN DETAIL			
								"A"	"B"	RETAIN	SALVAGE FROM	SALVAGE TO	REMOVE	RETAIN	REMOVE		1.75	2.00	2.50	FOUNDATION	3.00	3.50	4.00			5.00	DETAIL IN SHS	DETAIL ON SHEET NUMBER	DETAIL ON STD SHEET NUMBER
																	(LB / FT)				(LB / FT)								
BARRE TOWN VT 14							FY-FLUORESCENT YELLOW FYG-FLUORESCENT YELLOW GREEN															"SHS"-STANDARD HIGHWAY SIGNS							
NB	1.945	A	D11-1	24	18																								
		A	M7-1L	12	9																								
		A	D11-1	24	18																	3.00		X					
		A	M7-1L	12	9																	0.75			X				
NB	1.960	A	R8-3A	24	24																	4.00		X					
		A	M4-6	24	12																	2.00			X				
NB	1.970	C	VR-017	24	24																								
		C	N/A				TOWN PARKING REG																						
		C	W14-2				NO OUTLET																						
		C	VR-017	24	30																	5.00		X			E-141		
		C	N/A																										
		C	W14-2																										
NB	1.970	D	R1-1	24	24																								
		A	N/A				NO OUTLET																						
		D	R1-1	30	30																	6.25		X					
SIGN SUMMARY SHEET							SHEET TOTALS		21.00	0.00	0	2	2	5	0	0	5	75						PROJECT NAME: Hartford-East Montpelier VT14					
									SF	SF	EA	EA	EA	EA	EA	EA	EA	FT						PROJECT NUMBER: STPG SIGN(21)					
VERMONT AGENCY OF TRANSPORTATION							TOWN TOTALS		583.8	0.0	48.0	9.0	9.0	115	0.0	0.0	89	1335.0						FILE NAME: Barre Town.xls					
																							DESIGNED BY: A. Gamble						
																							PROJECT MANAGER: N. Avery						
																							DRAWN BY: T. Guazzoni						
																							CHECKED BY: S. Menard						
																							BARRE TOWN SHEET 8						
																							SHEET 122 OF 162						

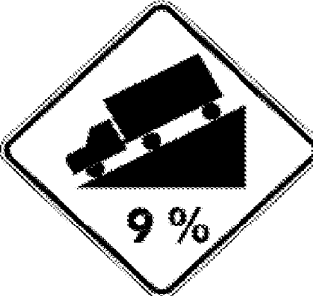

DIRECTION	MILEPOINT	LOCATION CODE (SHEET 2)	SIGN CODE	WIDTH (IN)	HEIGHT (IN)	SHEETING REMARKS	SIGN LEGEND FOR ALL POST LENGTHS AND INSTALLATION DATES SEE ORIGINAL RECORD PLANS	NEW SIGNS		EXISTING SIGNS				EXIST POST		NUMBER OF NEW POSTS	SQUARE STEEL (IN) (LB / FT)			TUBULAR STEEL Ø (IN) (LB / FT)				SIGN FRAME REQUIRED	REMARKS	SIGN DETAIL			
								"A"	"B"	RETAIN	SALVAGE FROM	SALVAGE TO	REMOVE	RETAIN	REMOVE		1.75	2.00	2.50	FOUNDATION	3.00	3.50	4.00			5.00	DETAIL IN SHS	DETAIL ON SHEET NUMBER	DETAIL ON STD SHEET NUMBER
BARRE TOWN VT 14							FY-FLUORESCENT YELLOW FYG-FLUORESCENT YELLOW GREEN															"SHS"-STANDARD HIGHWAY SIGNS							
		A	VR-038	24	18			3.00							1	X													E-141
		A	R2-1	30	36			7.50																			6		
		A	N/A				UNLESS OTHERWISE POSTED IN CITY LIMITS					1																	
NB	2.319	C	VD-025	60	7.5							1			X														
		C	VD-025	72	10			5.00							2	X											4		
		C	VD-700	6	10			0.42																					E-138
		C	VD-700	6	10			0.42				1																	E-138
		X																											
NB	2.321	C	VD-024	60	7.5							1			X														
		C	VD-025	72	10			5.00							2	X											4		
		C	VD-700	6	10			0.42																					E-138
		C	VD-700	6	10			0.42																					E-138
NB	2.325	A	VR-039	24	18							1			X														
		A	R2-1	24	30							1																	
		A	VR-039	24	18			3.00							1	X													E-141
SIGN SUMMARY SHEET							SHEET TOTALS	25.60 25.18	0.00	0	0	1	5 4	0	0	6	90							PROJECT NAME: Hartford-East Montpelier VT14 PROJECT NUMBER: STPG SIGN(21)					
VERMONT AGENCY OF TRANSPORTATION							TOWN TOTALS	583.8	0.0	48.0	9.0	9.0	115	0.0	0.0	89	1335.0							FILE NAME: Barre Town.xls PROJECT MANAGER: N. Avery DESIGNED BY: A. Gamble BARRE TOWN SHEET 10	PLOT DATE: 6/18/2009 DRAWN BY: T. Guazzoni CHECKED BY: S. Menard SHEET 124 OF 162				

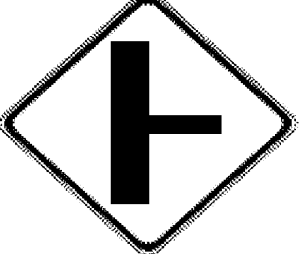





DIRECTION	MILEPOINT	LOCATION CODE (SHEET 2)	SIGN CODE	WIDTH (IN)	HEIGHT (IN)	SHEETING REMARKS	SIGN LEGEND FOR ALL POST LENGTHS AND INSTALLATION DATES SEE ORIGINAL RECORD PLANS	NEW SIGNS		EXISTING SIGNS				EXIST POST		NUMBER OF NEW POSTS	SQUARE STEEL (IN)			TUBULAR STEEL Ø (IN)				SIGN FRAME REQUIRED	REMARKS	SIGN DETAIL		
								"A"	"B"	RETAIN	SALVAGE FROM	SALVAGE TO	REMOVE	RETAIN	REMOVE		(LB / FT)			(LB / FT)						DETAIL IN SHS	DETAIL ON SHEET NUMBER	DETAIL ON STD SHEET NUMBER
																	1.75	2.00	2.50	FOUNDAION	3.00	3.50	4.00					
BARRE TOWN VT 14							FY-FLUORESCENT YELLOW FYG-FLUORESCENT YELLOW GREEN															"SHS"-STANDARD HIGHWAY SIGNS						
			A R2-1	24	30			5.00																	X			
NB	2.560		A R2-1	24	30		SPEED LIMIT 40						1		X													
			A W1-2R	30	30			6.25							1		X									X		
NB	2.675		A VD-062A	72	16		BUSINESS SIGN			1				X														
			A VD-062B	72	16		BUSINESS SIGN			1																		
NB	2.860		A W1-4L	30	30		REVERSE CURVE LEFT						1		X													
			A W1-5L	30	30		 	6.25					1			1		X								X		
			A W7-3A	24	18			3.00																		X		
NB	2.892		D R1-1	30	30			6.25							1		X								X		INSTALL GATEPOSTED STOP SIGN ON SOUTH SIDE OF PLAINFIELD BROOK RD	
NB	2.895		C VR-017	24	24								1		X												TH-5, PLAINFIELD BROOK RD	
			C N/A				TOWN PARKING REGULATION SIGN			1																		
			C VR-017	24	30			5.00							1		X										E-141	
			C N/A								1																RE-INSTALL TOWN'S PARKING REG SIGN BELOW LEGAL LOAD	
NB	2.905		D R1-1	24	24						1				X												TH-5, PLAINFIELD BROOK RD	
			D R1-1	30	30			6.25				1				X									X			
SIGN SUMMARY SHEET							SHEET TOTALS	38.00	0.00	2	2	2	5	0	0	5		75										
VERMONT AGENCY OF TRANSPORTATION							TOWN TOTALS	583.8	0.0	48.0	9.0	9.0	115	0.0	0.0	89		1335.0										
																												PROJECT NAME: Hartford-East Montpelier VT14 PROJECT NUMBER: STPG SIGN(21)
																												FILE NAME: Barre Town.xls PROJECT MANAGER: N. Avery DESIGNED BY: A. Gamble BARRE TOWN SHEET 11
																												PLOT DATE: 6/18/2009 DRAWN BY: T. Guazzoni CHECKED BY: S. Menard SHEET 125 OF 162

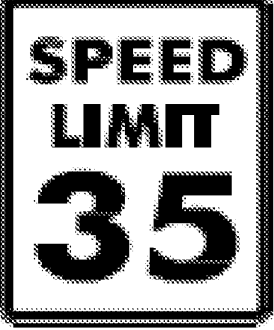

DIRECTION	MILEPOINT	LOCATION CODE (SHEET 2)	SIGN CODE	WIDTH (IN)	HEIGHT (IN)	SHEETING REMARKS	SIGN LEGEND FOR ALL POST LENGTHS AND INSTALLATION DATES SEE ORIGINAL RECORD PLANS	NEW SIGNS		EXISTING SIGNS				EXIST POST		NUMBER OF NEW POSTS	SQUARE STEEL (IN) (LB / FT)			TUBULAR STEEL Ø (IN) (LB / FT)				SIGN FRAME REQUIRED	REMARKS	SIGN DETAIL									
								"A"	"B"	RETAIN	SALVAGE FROM	SALVAGE TO	REMOVE	RETAIN	REMOVE		1.75	2.00	2.50	FOUNDATION	3.00	3.50	4.00			5.00	DETAIL IN SHS	DETAIL ON SHEET NUMBER	DETAIL ON STD SHEET NUMBER						
																	1.88	2.42	3.35		7.60	9.00	10.80			14.60									
BARRE TOWN VT 14							FY-FLUORESCENT YELLOW FYG-FLUORESCENT YELLOW GREEN															"SHS"-STANDARD HIGHWAY SIGNS													
NB	2.950	A	W2-2L	30	30		INTERSECTION WARNING			1					X																				
		A	W16-8A	30	8		PINE HILL RD			1																									
NB	3.175	A	R2-1	24	30										X																				
		A	R2-1	24	30			5.00								1		X															X		
NB	3.230	A	W11-6H	30	30		SNOWMOBILE (HINGED)			1					X																				
NB	3.340	A	W2-2MaR	30	30		 									1		X																6	
		A	W16-8A	24	8			1.33																									7		
NB	3.410	C	VR-017	24	24										1																				
		C	VR-017	24	30			5.00								1		X																	
NB	3.415	D	R1-1	24	24										1																				
		D	R1-1	30	30			6.25								1		X																	
NB	3.470	A	R2-1	24	30										1																				
		A	R2-1	24	30			5.00								1		X																	
NB	3.780	A	VW-060	30	30										1																				
		A	W1-4R					6.25								1		X																	
SIGN SUMMARY SHEET							SHEET TOTALS	41.33 35.08	0.00	3	0	0	4 5	0	0	6	90							PROJECT NAME: Hartford-East Montpelier VT14 PROJECT NUMBER: STPG SIGN(21)											
VERMONT AGENCY OF TRANSPORTATION							TOWN TOTALS	583.8	0.0	48.0	9.0	9.0	115	0.0	0.0	89	1335.0							FILE NAME: Barre Town.xls PROJECT MANAGER: N. Avery DESIGNED BY: A. Gamble BARRE TOWN SHEET 12		PLOT DATE: 6/18/2009 DRAWN BY: T. Guazzoni CHECKED BY: S. Menard SHEET 126 OF 162									

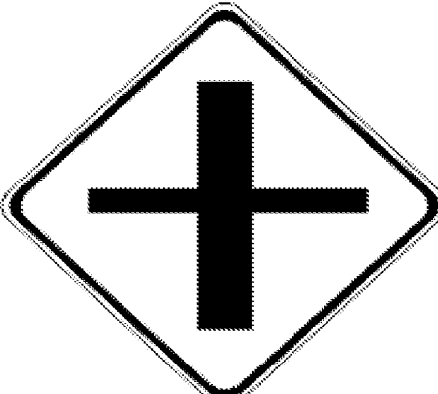

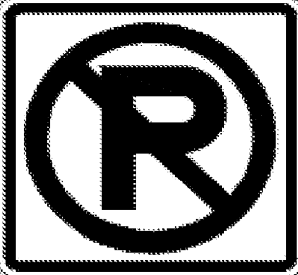

DIRECTION	MILEPOINT	LOCATION CODE (SHEET 2)	SIGN CODE	WIDTH (IN)	HEIGHT (IN)	SHEETING REMARKS	SIGN LEGEND FOR ALL POST LENGTHS AND INSTALLATION DATES SEE ORIGINAL RECORD PLANS	NEW SIGNS		EXISTING SIGNS				EXIST POST		NUMBER OF NEW POSTS	SQUARE STEEL (IN)			TUBULAR STEEL Ø (IN)				SIGN FRAME REQUIRED	REMARKS	SIGN DETAIL			
								"A"	"B"	RETAIN	SALVAGE FROM	SALVAGE TO	REMOVE	RETAIN	REMOVE		1.75	2.00	2.50	FOUNDATION	3.00	3.50	4.00			5.00	DETAIL IN SHS	DETAIL ON SHEET NUMBER	DETAIL ON STD SHEET NUMBER
																	(LB / FT)				(LB / FT)								
BARRE TOWN VT 14							FY-FLUORESCENT YELLOW FYG-FLUORESCENT YELLOW GREEN															"SHS"-STANDARD HIGHWAY SIGNS							
			VW-060	30	30			6.25																	E-154				
SB	3.825	G	VR-017	24	24					1		1		X															
		G	VR-017	24	30			5.00			1				X										TH-13, SUNBAY RD	E-141			
SB	3.820	H	R1-1	24	24							1		X															
		H	R1-1	30	30			6.25							X									X	TH-13, SUNBAY RD				
SB	3.680	F	VW-168R	30	30		HIDDEN SIDE RD RIGHT 					1		X															
SB	3.640	F	W1-4L	30	30			6.25							1		X							X	INSTALL 200 FT +/- SOUTH OF EXISTING HIDDEN SIDE ROAD SIGN (TO BE REMOVED)				
		F	VW-054	30	30			6.25																	E-154				
SB	3.600	F	R2-5A	24	30		REDUCED SPEED AHEAD					1		X															
SB	3.570	F	W3-5	36	36			9.00							2		X							X	INSTALL 150 FT +/- SOUTH OF EXISTING RSA (TO BE REMOVED)				
SB	3.470	F	R2-1	24	30							1		X															
		F	R2-1	30	36			7.50							1		X								6				
SB	3.450	F	W7-1	30	30							1		X															
		F	W7-1B	30	30			6.25							1		X							X					
SB	3.400	F	W11-6H	30	30		SNOWMOBILE (HINGED)			1				X															
SIGN SUMMARY SHEET							SHEET TOTALS	52.75	0.00	1	0	0	6	0	0	7	105												
							SF SF EA EA EA EA EA EA EA EA EA									FT													
VERMONT AGENCY OF TRANSPORTATION							TOWN TOTALS	583.8	0.0	48.0	9.0	9.0	115	0.0	0.0	89	1335.0												
PROJECT NAME: Hartford-East Montpelier VT14																					PROJECT NUMBER: STPG SIGN(21)								
FILE NAME: Barre Town.xls												PLOT DATE: 6/18/2009																	
PROJECT MANAGER: N. Avery												DRAWN BY: T. Guazzoni																	
DESIGNED BY: A. Gamble												CHECKED BY: S. Menard																	
BARRE TOWN SHEET 13												SHEET 127 OF 162																	

DIRECTION	MILEPOINT	LOCATION CODE (SHEET 2)	SIGN CODE	WIDTH (IN)	HEIGHT (IN)	SHEETING REMARKS	SIGN LEGEND FOR ALL POST LENGTHS AND INSTALLATION DATES SEE ORIGINAL RECORD PLANS	NEW SIGNS		EXISTING SIGNS				EXIST POST		NUMBER OF NEW POSTS	SQUARE STEEL (IN) (LB / FT)			TUBULAR STEEL Ø (IN) (LB / FT)				SIGN FRAME REQUIRED	REMARKS	SIGN DETAIL			
								"A"	"B"	RETAIN	SALVAGE FROM	SALVAGE TO	REMOVE	RETAIN	REMOVE		1.75	2.00	2.50	FOUNDATION	3.00	3.50	4.00			5.00	DETAIL IN SHS	DETAIL ON SHEET NUMBER	DETAIL ON STD SHEET NUMBER
																	1.88	2.42	3.35		7.60	9.00	10.80			14.60			
BARRE TOWN VT 14							FY-FLUORESCENT YELLOW FYG-FLUORESCENT YELLOW GREEN														"SHS"-STANDARD HIGHWAY SIGNS								
SB	3.290	F	W1-5R	30	30			6.25							1	X							INSTALL BY NORTH CORNER OF PARKING LOT	X					
			W7-3A	24	18				3.00															X					
SB	3.220	F	W1-4R	30	30		REVERSE CURVE									1	X												
SB	3.200	F	W2-2R	30	30		SIDE ROAD RIGHT									1	X												
		F	W16-8A	30	8		PINE HILL RD PLAQUE									1													
SB	3.120	F	R2-1	24	30											1	X												
		F	R2-1	24	30				5.00								1	X						X					
SB	3.090	F	W2-2MaR	30	30		 Pine Hill Rd	6.25								1	X							INSTALL 10 FT NORTH OF UTILITY POLE		6			
		F	W16-8A	30	8				1.67																	7			
SB	3.025	G	VR-017	24	24												1	X											
		G	VR-017	24	30				5.00								1	X						TH-9, PINE HILL RD			E-141		
SB	3.020	H	R1-1	24	24												1	X											
		H	R1-2	30	30				6.25								1	X						TH-9, PINE HILL RD	X				
SB	2.700	F	R2-1	24	30												1	X											
		F	R2-1	24	30				5.00								1	X							X				
SIGN SUMMARY SHEET							SHEET TOTALS	38.42	0.00	0	0	0	7	0	0	6	90						PROJECT NAME: Hartford-East Montpelier VT14						
VERMONT AGENCY OF TRANSPORTATION							TOWN TOTALS	583.8	0.0	48.0	9.0	9.0	115	0.0	0.0	89	1335.0						PROJECT NUMBER: STPG SIGN(21)						
								SF	SF	EA	EA	EA	EA	EA	EA	EA	FT						FILE NAME: Barre Town.xls						
																							PROJECT MANAGER: N. Avery						
																							DESIGNED BY: A. Gamble						
																								BARRE TOWN SHEET 14					
																								PLOT DATE: 6/18/2009					
																									DRAWN BY: T. Guazzoni				
																										CHECKED BY: S. Menard			
																											SHEET 128 OF 162		

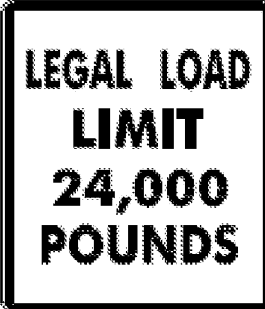
DIRECTION	MILEPOINT	LOCATION CODE (SHEET 2)	SIGN CODE	WIDTH (IN)	HEIGHT (IN)	SHEETING REMARKS	SIGN LEGEND	NEW SIGNS		EXISTING SIGNS				EXIST POST		NUMBER OF NEW POSTS	SQUARE STEEL (IN)			TUBULAR STEEL Ø (IN)				SIGN FRAME REQUIRED	REMARKS	SIGN DETAIL							
								"A"	"B"	RETAIN	SALVAGE FROM	SALVAGE TO	REMOVE	RETAIN	REMOVE		1.75	2.00	2.50	FOUNDATION	3.00	3.50	4.00			5.00	DETAIL IN SHS	DETAIL ON SHEET NUMBER	DETAIL ON STD SHEET NUMBER				
																	(LB / FT)				(LB / FT)												
BARRE TOWN VT 14							FY-FLUORESCENT YELLOW FYG-FLUORESCENT YELLOW GREEN															"SHS"-STANDARD HIGHWAY SIGNS											
SB	2.490	F	VD-062B	74.75	16		BUSINESS SIGN			1					X																		
SB	2.490	F	VD-062C	74.75	16		BUSINESS SIGN			1																							
SB	2.430	F	R2-5A	24	30		REDUCED SPEED AHEAD																										
		F	W3-5	36	36			9.00																							X		
SB	2.364	F	VD-062B	72	16		BUSINESS SIGN			1					X																		
SB	2.321	F	VR-038	24	24		STATE HIGHWAY ENDS																										
		F	R2-1	24	30		SPEED LIMIT 25																										
		F	N/A				UNLESS OTHERWISE POSTED IN CITY LIMITS			1																							
		F	VR-038	24	18			3.00																							E-141		
		F	R2-1	30	36			7.50																							6		
		F	N/A																														
																															2.1 MILES IN BARRE CITY, THEN BARRE TOWN RESUMES		
SB	2.319	G	VD-024	60	7.5		STATE HIGHWAY BEGIN																								NEW TL SIGN IS ON NB SIDE		
SB	2.319	F	VR-039	24	18		STATE HIGHWAY BEGINS																										
		F	R2-1	24	30		SPEED LIMIT 35																										
SIGN SUMMARY SHEET							SHEET TOTALS	19.50	0.00	3	1	1	6	0	0	3	45																PROJECT NAME: Hartford-East Montpelier VT14
								SF	SF	EA	EA	EA	EA	EA	EA	EA	FT															PROJECT NUMBER: STPG SIGN(21)	
VERMONT AGENCY OF TRANSPORTATION							TOWN TOTALS	583.8	0.0	48.0	9.0	9.0	115	0.0	0.0	89	1335.0																FILE NAME: Barre Town.xls
																																PLOT DATE: 6/18/2009	
																																DESIGNED BY: A. Gamble	
																																CHECKED BY: S. Menard	
																																SHEET 129 OF 162	

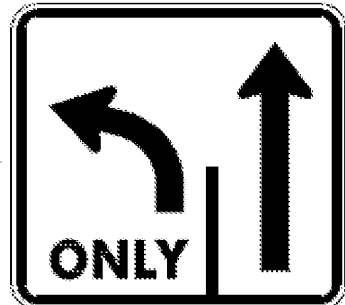
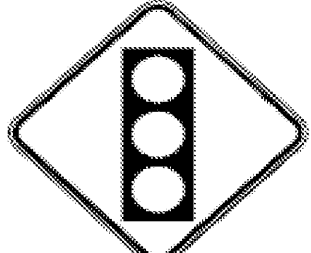

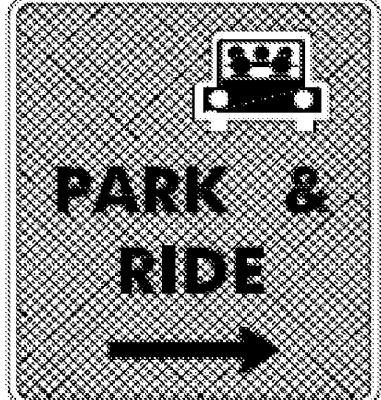
DIRECTION	MILEPOINT	LOCATION CODE (SHEET 2)	SIGN CODE	WIDTH (IN)	HEIGHT (IN)	SHEETING REMARKS	SIGN LEGEND FOR ALL POST LENGTHS AND INSTALLATION DATES SEE ORIGINAL RECORD PLANS	NEW SIGNS		EXISTING SIGNS				EXIST POST		NUMBER OF NEW POSTS	SQUARE STEEL (IN)			TUBULAR STEEL Ø (IN)				SIGN FRAME REQUIRED	REMARKS	SIGN DETAIL		
								"A"	"B"	RETAIN	SALVAGE FROM	SALVAGE TO	REMOVE	RETAIN	REMOVE		1.75	2.00	2.50	3.00	3.50	4.00	5.00			DETAIL IN SHS	DETAIL ON SHEET NUMBER	DETAIL ON STD SHEET NUMBER
																	(LB / FT)			(LB / FT)								
BARRE TOWN VT 14							FY-FLUORESCENT YELLOW FYG-FLUORESCENT YELLOW GREEN															"SHS"-STANDARD HIGHWAY SIGNS						
			F VR-039	24	18			3.00							1	X											E-141	
			F R2-1	24	30			5.00																X				
SB	2.170		F VD-018	30	18									1		X											E-128B	
			F VD-018	30	18			3.75							1	X												
SB	2.120		F W2-1	36	36									1		X											ASSEMBLY HAS FLASHING BEACONS. RETAIN POSTS AND BEACONS.	
			F W16-2	24	18									1														
			F W2-1Mb	36	36	FY		9.00																		6		
			F W16-2	24	18	FY		3.00																X				
SB	2.080		F R2-1	24	30									1		X												
			F R2-1	24	30			5.00							1	X								X				
SB	2.060		F W11-2	30	30	PEDESTRIAN								1		X												
			F W11-2	30	30	FYG		6.25							1	X								X			INSTALL 50 FT +/- SOUTH OF EXISTING (TO BE REMOVED)	
SB	1.980		G VR-017	24	24																						TH-7, BRIDGE ST	
			G N/A			TOWN PARKING REGULATION SIGN																						
			G VR-017	24	30			5.00							1	X											E-141	
SIGN SUMMARY SHEET							SHEET TOTALS	40.00	0.00	0	2	0	6	0	0	5	75											
VERMONT AGENCY OF TRANSPORTATION							TOWN TOTALS	583.8	0.0	48.0	9.0	9.0	115	0.0	0.0	89	1335.0											
							PROJECT NAME: Hartford-East Montpelier VT14																					
							PROJECT NUMBER: STPG SIGN(21)																					
							FILE NAME: Barre Town.xls					PLOT DATE: 6/18/2009																
							PROJECT MANAGER: N. Avery					DRAWN BY: T. Guazzoni																
							DESIGNED BY: A. Gamble					CHECKED BY: S. Menard																
							BARRE TOWN SHEET 16					SHEET 130 OF 162																

DIRECTION	MILEPOINT	LOCATION CODE (SHEET 2)	SIGN CODE	WIDTH (IN)	HEIGHT (IN)	SHEETING REMARKS	SIGN LEGEND FOR ALL POST LENGTHS AND INSTALLATION DATES SEE ORIGINAL RECORD PLANS	NEW SIGNS		EXISTING SIGNS				EXIST POST		NUMBER OF NEW POSTS	SQUARE STEEL (IN)			TUBULAR STEEL Ø (IN)				SIGN FRAME REQUIRED	REMARKS	SIGN DETAIL				
								"A"	"B"	RETAIN	SALVAGE FROM	SALVAGE TO	REMOVE	RETAIN	REMOVE		1.75	2.00	2.50	FOUNDATION	3.00	3.50	4.00			5.00	DETAIL IN SHS	DETAIL ON SHEET NUMBER	DETAIL ON STD SHEET NUMBER	
																	(LB / FT)				(LB / FT)									
BARRE TOWN VT 14							FY-FLUORESCENT YELLOW FYG-FLUORESCENT YELLOW GREEN															"SHS"-STANDARD HIGHWAY SIGNS								
			G	N/A			TOWN PARKING REGULATION SIGN																			RE-INSTALL TOWN'S PARKING REG SIGN BELOW LEGAL LOAD				
SB	1.975		H	R1-1	24	24																				TH-7, BRIDGE ST				
			H	R1-1	30	30		6.25																			X			
SB	1.970		F	R8-3	24	30																								
			F	R8-3A	24	24		4.00																			X			
SB	1.945		F	R8-3	24	30																								
			F	R8-3A	24	24		4.00																			X			
SB	1.930		F	VD-062A	72	16	BUSINESS SIGN			1																				
SB	1.930		F	VD-062A	72	16	BUSINESS SIGN			1																				
SB	1.875		F	R2-1	24	30																								
			F	R2-1	24	30		5.00																			X			
SB	1.865		G	VR-017	24	24																				TH-110, STEVENS LANE				
			G	N/A				TOWN PARKING REGULATION SIGN			1																			
			G	VR-017	24	30		5.00																						E-141
			G	N/A				TOWN PARKING REGULATION SIGN																			RE-INSTALL TOWN'S PARKING REG SIGN BELOW LEGAL LOAD			
SIGN SUMMARY SHEET							SHEET TOTALS	24.25	0.00	2	1	4	6	0	0	5	75							PROJECT NAME: Hartford-East Montpelier VT14						
								SF	SF	EA	EA	EA	EA	EA	EA	EA	FT							PROJECT NUMBER: STPG SIGN(21)						
VERMONT AGENCY OF TRANSPORTATION							TOWN TOTALS	583.8	0.0	48.0	9.0	9.0	115	0.0	0.0	89	1335.0							FILE NAME: Barre Town.xls PLOT DATE: 6/18/2009						
																								PROJECT MANAGER: N. Avery DRAWN BY: T. Guazzoni						
																								DESIGNED BY: A. Gamble CHECKED BY: S. Menard						
																								BARRE TOWN SHEET 17 SHEET 131 OF 162						









DIRECTION	MILEPOINT	LOCATION CODE (SHEET 2)	SIGN CODE	WIDTH (IN)	HEIGHT (IN)	SHEETING REMARKS	SIGN LEGEND	NEW SIGNS		EXISTING SIGNS				EXIST POST		NUMBER OF NEW POSTS	SQUARE STEEL (IN)			TUBULAR STEEL Ø (IN)				SIGN FRAME REQUIRED	REMARKS	SIGN DETAIL			
								"A"	"B"	RETAIN	SALVAGE FROM	SALVAGE TO	REMOVE	RETAIN	REMOVE		1.75	2.00	2.50	FOUNDATION	3.00	3.50	4.00			5.00	DETAIL IN SHS	DETAIL ON SHEET NUMBER	DETAIL ON STD SHEET NUMBER
																	(LB / FT)				(LB / FT)								
BARRE TOWN VT 14							FY-FLUORESCENT YELLOW FYG-FLUORESCENT YELLOW GREEN															"SHS"-STANDARD HIGHWAY SIGNS							
SB	1.860	H	R1-1	24	24																								
		H	R1-1	30	30			6.25											X					X					
SB	1.830	F	VR-921L	30	30																								
		F	VR-921L	30	30			6.25																	E-145A				
SB	1.800	F	W3-3	36	36																								
		F	W3-3	36	36			9.00																X					
SB	1.795	F	M2-1	21	15		JCT																						
		F	M1-5	24	24		VT 63																						
SB	1.785	F	M2-1	21	15			2.19																					
		F	M1-5	24	24			4.00																E-136B					
SB	1.775	F	D4-2	30	36																								
		F	VD-365	30	6		1-800-685-RIDE																						
		F	D4-2	30	36			7.50																					
SB	1.755	H	R1-1	30	30																								
		H	R1-1	30	30			6.25																					
SIGN SUMMARY SHEET							SHEET TOTALS	41.44	0.00	0	0	0	8	0	0	7	105						PROJECT NAME: Hartford-East Montpelier VT14						
							SF	SF	EA	EA	EA	EA	EA	EA	EA	EA	FT						PROJECT NUMBER: STPG SIGN(21)						
VERMONT AGENCY OF TRANSPORTATION							TOWN TOTALS	583.8	0.0	48.0	9.0	9.0	115	0.0	0.0	89	1335.0						FILE NAME: Barre Town.xls	PLOT DATE: 6/18/2009					
																						PROJECT MANAGER: N. Avery	DRAWN BY: T. Guazzoni						
																						DESIGNED BY: A. Gamble	CHECKED BY: S. Menard						
																						BARRE TOWN SHEET 18	SHEET 132 OF 162						



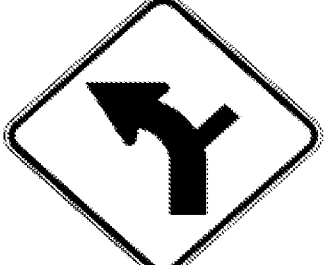

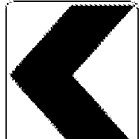

DIRECTION	MILEPOINT	LOCATION CODE (SHEET 2)	SIGN CODE	WIDTH (IN)	HEIGHT (IN)	SHEETING REMARKS	SIGN LEGEND FOR ALL POST LENGTHS AND INSTALLATION DATES SEE ORIGINAL RECORD PLANS	NEW SIGNS		EXISTING SIGNS				EXIST POST		NUMBER OF NEW POSTS	SQUARE STEEL (IN)			TUBULAR STEEL Ø (IN)				SIGN FRAME REQUIRED	REMARKS	SIGN DETAIL			
								"A"	"B"	RETAIN	SALVAGE FROM	SALVAGE TO	REMOVE	RETAIN	REMOVE		1.75	2.00	2.50	FOUNDATION	3.00	3.50	4.00			5.00	DETAIL IN SHS	DETAIL ON SHEET NUMBER	DETAIL ON STD SHEET NUMBER
																	(LB / FT)				(LB / FT)								
BARRE TOWN VT 14							FY-FLUORESCENT YELLOW FYG-FLUORESCENT YELLOW GREEN															"SHS"-STANDARD HIGHWAY SIGNS							
SB	1.735	F	D1-1A	54	7.5																								
		F	D1-1A	54	7.5																								
		F	D1-1A	72	12			6.00						2			X								5				
		F	D1-1A	72	12			6.00																	5				
SB	1.715	F	VR922L	36	30																								
		F	VR922L	36	30			7.50						1 2			X								E-145A				
SB	1.700	F	M3-3	24	12																								
		F	M1-5	24	24																								
		F	M6-3	21	15																								
		F	M3-4	24	12																								
		F	M1-5	24	24																								
		F	M6-1	21	15																								
		F	M4-5	24	12																								
		F	M1-1	24	24																								
		F	M6-1	21	15																								
SIGN SUMMARY SHEET							SHEET TOTALS	19.50	0.00	0	0	0	12	0	0	3 4	60						PROJECT NAME: Hartford-East Montpelier VT14 PROJECT NUMBER: STPG SIGN(21)						
VERMONT AGENCY OF TRANSPORTATION							TOWN TOTALS	583.8	0.0	48.0	9.0	9.0	115	0.0	0.0	89	1335.0						FILE NAME: Barre Town.xls PLOT DATE: 6/18/2009 PROJECT MANAGER: N. Avery DRAWN BY: T. Guazzoni DESIGNED BY: A. Gamble CHECKED BY: S. Menard BARRE TOWN SHEET 19 SHEET 133 OF 162						



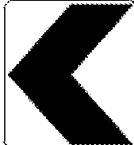

DIRECTION	MILEPOINT	LOCATION CODE (SHEET 2)	SIGN CODE	WIDTH (IN)	HEIGHT (IN)	SHEETING REMARKS	SIGN LEGEND FOR ALL POST LENGTHS AND INSTALLATION DATES SEE ORIGINAL RECORD PLANS	NEW SIGNS		EXISTING SIGNS				EXIST POST		NUMBER OF NEW POSTS	SQUARE STEEL (IN)			TUBULAR STEEL Ø (IN)				SIGN FRAME REQUIRED	REMARKS	SIGN DETAIL			
								"A"	"B"	RETAIN	SALVAGE FROM	SALVAGE TO	REMOVE	RETAIN	REMOVE		1.75	2.00	2.50	FOUNDATION	3.00	3.50	4.00			5.00	DETAIL IN SHS	DETAIL ON SHEET NUMBER	DETAIL ON STD SHEET NUMBER
																	(LB / FT)				(LB / FT)								
BARRE TOWN VT 14							FY-FLUORESCENT YELLOW FYG-FLUORESCENT YELLOW GREEN															"SHS"-STANDARD HIGHWAY SIGNS							
		F	M3-3	24	12			2.00							2	X						#3	GREEN ON WHITE SHEETING	X	7				
		F	M1-5	24	24			4.00																		E-136B			
		F	M6-3	21	15			2.19															GREEN ON WHITE SHEETING	X					
		F	M3-4	24	12			2.00															GREEN ON WHITE SHEETING	X					
		F	M1-5	24	24			4.00																		E-136B			
		F	M6-1	21	15			2.19															GREEN ON WHITE SHEETING	X					
		F	M4-5	24	12			2.00															WHITE ON BLUE SHEETING	X					
		F	M1-1	24	24			4.00																X					
		F	M6-1	21	15			2.19															WHITE ON BLUE SHEETING	X					
SB	1.690	N	R10-12	24	30																								
		N	R10-12	24	30			5.00									X						INSTALL ON SPAN WIRE NEXT TO LEFT TURN SIGNAL	X					
SB	1.635	F	R2-1	24	30																								
		F	R2-1	24	30			5.00							1	X								X					
SB	1.560	G	VR-017	24	24		LEGAL LOAD LIMIT 24000 LBS				1															TH-59, SNOWBRIDGE RD (NORTH)			
SB	1.550	H	R1-1	24	24		STOP				1															TH-59, SNOWBRIDGE RD (NORTH)			
SIGN SUMMARY SHEET							SHEET TOTALS	34.57	0.00	2	0	0	2	0	0	3	60							PROJECT NAME: Hartford-East Montpelier VT14					
VERMONT AGENCY OF TRANSPORTATION							TOWN TOTALS	583.8	0.0	48.0	9.0	9.0	115	0.0	0.0	89	1335.0							PROJECT NUMBER: STPG SIGN(21)					
							SF	SF	EA	EA	EA	EA	EA	EA	EA	EA	FT								FILE NAME: Barre Town.xls				
																										PROJECT MANAGER: N. Avery			
																										DESIGNED BY: A. Gamble			
																										BARRE TOWN SHEET 20			
																										PLOT DATE: 6/18/2009			
																										DRAWN BY: T. Guazzoni			
																										CHECKED BY: S. Menard			
																										SHEET 134 OF 162			

DIRECTION	MILEPOINT	LOCATION CODE (SHEET 2)	SIGN CODE	WIDTH (IN)	HEIGHT (IN)	SHEETING REMARKS	SIGN LEGEND	NEW SIGNS		EXISTING SIGNS				EXIST POST		NUMBER OF NEW POSTS	SQUARE STEEL (IN)			TUBULAR STEEL Ø (IN)				SIGN FRAME REQUIRED	REMARKS	SIGN DETAIL			
								"A"	"B"	RETAIN	SALVAGE FROM	SALVAGE TO	REMOVE	RETAIN	REMOVE		1.75	2.00	2.50	FOUNDATION	3.00	3.50	4.00			5.00	DETAIL IN SHS	DETAIL ON SHEET NUMBER	DETAIL ON STD SHEET NUMBER
																	(LB / FT)				(LB / FT)								
BARRE TOWN VT 14							FY-FLUORESCENT YELLOW FYG-FLUORESCENT YELLOW GREEN															"SHS"-STANDARD HIGHWAY SIGNS							
SB	1.450	G	VR-017	24	24		LEGAL LOAD LIMIT 24000 LBS			1																TH-59, SNOWBRIDGE RD (SOUTH)			
SB	1.445	H	R1-1	24	24		STOP			1																TH-59, SNOWBRIDGE RD (SOUTH)			
SB	1.440	F	R2-1	24	30																								
		F	R2-1	24	30			5.00																				X	
SB	1.000	F	R2-1	24	30																								
		F	R2-1	24	30			5.00																				X	
SB	0.540	F	R2-1	24	30																								
		F	R2-1	24	30			5.00																				X	
SB	0.050	F	W11-10	30	30		TRUCK ENTERING SYMBOL			1																			ASSEMBLY HAS SOLAR FLASHING BEACON ATTACHED
		F	S4-4M	24	10		WHEN FLASHING (YELLOW BKGRND)			1																			
SIGN SUMMARY SHEET							SHEET TOTALS	15.00	0.00	4	0	0	3	0	0	3	45							PROJECT NAME: Hartford-East Montpelier VT14					
							SF	SF	EA	EA	EA	EA	EA	EA	EA	EA	FT							PROJECT NUMBER: STPG SIGN(21)					
VERMONT AGENCY OF TRANSPORTATION							TOWN TOTALS	583.8	0.0	48.0	9.0	9.0	115	0.0	0.0	89	1335.0							FILE NAME: Barre Town.xls					
																							PLOT DATE: 6/18/2009						
																							DRAWN BY: T. Guazzoni						
																							DESIGNED BY: A. Gamble						
																							CHECKED BY: S. Menard						
																						BARRE TOWN SHEET 21							
																						SHEET 135 OF 162							





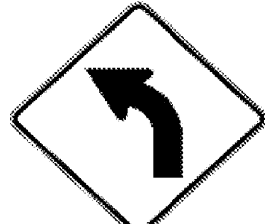
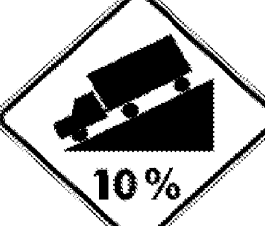

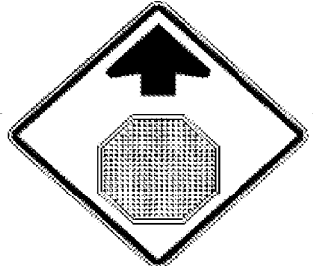
DIRECTION	MILEPOINT	LOCATION CODE (SHEET 2)	SIGN CODE	WIDTH (IN)	HEIGHT (IN)	SHEETING REMARKS	SIGN LEGEND FOR ALL POST LENGTHS AND INSTALLATION DATES SEE ORIGINAL RECORD PLANS	NEW SIGNS		EXISTING SIGNS				EXIST POST		NUMBER OF NEW POSTS	SQUARE STEEL (IN) (LB / FT)			TUBULAR STEEL Ø (IN) (LB / FT)				SIGN FRAME REQUIRED	REMARKS	SIGN DETAIL					
								"A"	"B"	RETAIN	SALVAGE FROM	SALVAGE TO	REMOVE	RETAIN	REMOVE		FOUNDATION	3.00	3.50	4.00	5.00	DETAIL IN SHS	DETAIL ON SHEET NUMBER			DETAIL ON STD SHEET NUMBER					
																											1.75	2.00	2.50	7.60	9.00
E MONTPELIER VT 14							FY-FLUORESCENT YELLOW FYG-FLUORESCENT YELLOW GREEN															"SHS"-STANDARD HIGHWAY SIGNS									
NB	0.000	A	VD-024	72	10			5.00										X							INSTALL OPPOSITE EXISTING TOWN LINE SIGN		4				
		A	VD-700	6	10			0.42																	EAST MONTPELIER MILE MARKER. INSTALL ON LEFT POST UNDER EAST MONTPELIER				E-138		
		A	VD-700	6	10			0.42																	BARRE TOWN MILE MARKER. INSTALL ON RIGHT POST UNDER BARRE TOWN				E-138		
NB	0.550	A	W11-6H	30	30																										
		A	W11-6H	30	30	HINGED		6.25										X							INSTALL IN CLOSED POSITION				E-153		
NB	0.705	A	M1-5A	24	24		ROUTE MARKER																								
NB	0.930	A	VD-062A	72	16		BUSINESS SIGN			1																					
		A	VD-062B	72	16					1																					
NB	0.970	A	W11-6H	30	30																										
		A	W11-6H	30	30	HINGED		6.25										X							INSTALL IN CLOSED POSITION				E-153		
NB	1.070	A	W1-4L	30	30		REVERSE CURVE W/SIDE RD																								
		A	W13-1	18	18		35 MPH PLAQUE																								
		A	W1-4ML	30	30			6.25										X													
		A	W16-8	30	8			1.67																	EAST HILL RD				7		
NB	1.265	C	VR-017	24	30																										
SIGN SUMMARY SHEET							SHEET TOTALS	26.26	0.00	2	0	0	5	75												PROJECT NAME: Hartford-East Montpelier VT14					
VERMONT AGENCY OF TRANSPORTATION								SF	SF	EA	EA	EA	EA	EA	EA	EA	EA	EA	EA	EA	EA	EA	EA	EA		PROJECT NUMBER: STPG SIGN(21)					
							TOWN TOTALS	803.2	0.0	27.0	3.0	3.0	149	1980.0											FILE NAME: East Montpelier.xls						
																									PROJECT MANAGER: N. Avery						
																									DESIGNED BY: M. Miller						
																									PLOT DATE: 6/18/2009						
																									PROJECT MANAGER: N. Avery						
																										DESIGNED BY: M. Miller					
																										CHECKED BY: S. Menard					
																										SHEET 136 OF 162					



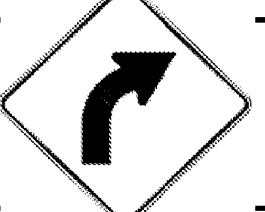
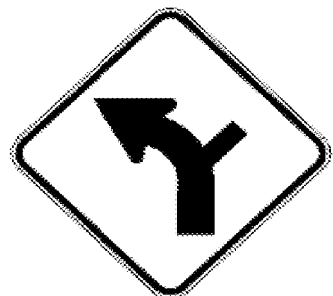



DIRECTION	MILEPOINT	LOCATION CODE (SHEET 2)	SIGN CODE	WIDTH (IN)	HEIGHT (IN)	SHEETING REMARKS	SIGN LEGEND	NEW SIGNS		EXISTING SIGNS				EXIST POST		NUMBER OF NEW POSTS	SQUARE STEEL (IN)			TUBULAR STEEL Ø (IN)				SIGN FRAME REQUIRED	REMARKS	SIGN DETAIL			
								"A"	"B"	RETAIN	SALVAGE FROM	SALVAGE TO	REMOVE	RETAIN	REMOVE		1.75	2.00	2.50	FOUNDATION	3.00	3.50	4.00			5.00	DETAIL IN SHS	DETAIL ON SHEET NUMBER	DETAIL ON STD SHEET NUMBER
																	(LB / FT)				(LB / FT)								
E MONTPELIER VT 14							FY-FLUORESCENT YELLOW FYG-FLUORESCENT YELLOW GREEN															"SHS"-STANDARD HIGHWAY SIGNS							
		C	VR-017	24	30			5.00							1	X							TH 52, EAST HILL RD			E-141			
NB	1.275	D	R1-1	30	30								1																
		D	R1-1	30	30			6.25							1	X							TH 52, EAST HILL RD	X					
NB	1.460	A	W1-2L	30	30		LEFT CURVE W/SIDE RDS						1																
		A	W13-1	18	18		35 MPH PLAQUE						1																
NB	1.505	A	W1-10L	30	30			6.25							1	X							INSTALL 250 FT +/- NORTH OF EXISTING	X					
		A	W16-8	24	8			1.33															FAIR RD		7				
NB	1.545	B	W1-8R	18	24							1																	
		A	W1-8L	24	30	FY		5.00							1	X							INSTALL ON SEPARATE POSTS 5 FEET APART	X					
		B	W1-8R	24	30	FY		5.00							1	X													
NB	1.565	B	W1-8R	18	24							1																	
		A	W1-8L	24	30	FY		5.00							1	X							INSTALL ON SEPARATE POSTS 5 FEET APART	X					
		B	W1-8R	24	30	FY		5.00							1	X													
NB	1.580	D	R1-1	24	24							1																	
		D	R1-1	30	30			6.25							1	X							TH 51, FAIR RD	X					
SIGN SUMMARY SHEET							SHEET TOTALS	45.08	0.00	0	0	0	6	0	0	8	120							PROJECT NAME: Hartford-East Montpelier VT14					
							SF	SF	EA	EA	EA	EA	EA	EA	EA	EA	FT							PROJECT NUMBER: STPG SIGN(21)					
VERMONT AGENCY OF TRANSPORTATION							TOWN TOTALS	803.2	0.0	27.0	3.0	3.0	149	0.0	0.0	132	1980.0							FILE NAME: East Montpelier.xls	PLOT DATE: 6/18/2009				
																							PROJECT MANAGER: N. Avery	DRAWN BY: T. Guazzoni					
																							DESIGNED BY: M. Miller	CHECKED BY: S. Menard					
																							EAST MONTPELIER SHEET 2	SHEET 137 OF 162					



DIRECTION	MILEPOINT	LOCATION CODE (SHEET 2)	SIGN CODE	WIDTH (IN)	HEIGHT (IN)	SHEETING REMARKS	SIGN LEGEND FOR ALL POST LENGTHS AND INSTALLATION DATES SEE ORIGINAL RECORD PLANS	NEW SIGNS		EXISTING SIGNS				EXIST POST		NUMBER OF NEW POSTS	SQUARE STEEL (IN)			TUBULAR STEEL Ø (IN)				SIGN FRAME REQUIRED	REMARKS	SIGN DETAIL			
								"A"	"B"	RETAIN	SALVAGE FROM	SALVAGE TO	REMOVE	RETAIN	REMOVE		1.75	2.00	2.50	FOUNDATION	3.00	3.50	4.00			5.00	DETAIL IN SHS	DETAIL ON SHEET NUMBER	DETAIL ON STD SHEET NUMBER
																	(LB / FT)				(LB / FT)								
E MONTPELIER VT 14							FY-FLUORESCENT YELLOW FYG-FLUORESCENT YELLOW GREEN															"SHS"-STANDARD HIGHWAY SIGNS							
NB	1.590	A	W1-8R	18	24																				EXISTING ON SINGLE POST BACK TO BACK				
		B	W1-8R	18	24																								
		A	W1-8L	24	30	FY		5.00																	INSTALL ON SEPARATE POSTS 5 FEET APART	X			
		B	W1-8R	24	30	FY		5.00																		X			
NB	1.595	A	W11-6H	30	30																				EXISTING SIGN REMOVED				
		A	W11-6H	30	30	HINGED		6.25																	INSTALL IN CLOSED POSITION			E-153	
NB	1.600	C	VR-017	24	30						1	1	1												REMOVE & SALVAGED STREET SIGN TH 51, FAIR RD				
		C	VR-017	24	30			5.00																	INSTALL 50 FT +/- DOWN TOWN HWY, BEYOND "Y"			E-141	
NB	1.605	D	R1-1	24	24																				REMOVED MM PLAQUE				
		D	R1-1	30	30			6.25																	TH 51, FAIR RD	X			
NB	1.610	A	W1-8R	18	24																								
		B	W1-8R	18	24																								
		A	W1-8L	24	30	FY		5.00																	INSTALL ON SEPARATE POSTS 5 FEET APART	X			
		B	W1-8R	24	30	FY		5.00																		X			
NB	1.630	A	W1-8R	18	24																								
SIGN SUMMARY SHEET							SHEET TOTALS	37.50	0.00	0	0	0	0	0	0	0	7	105						PROJECT NAME: Hartford-East Montpelier VT14					
VERMONT AGENCY OF TRANSPORTATION							TOWN TOTALS	803.2	0.0	27.0	3.0	3.0	149	0.0	0.0	132	1980.0							PROJECT NUMBER: STPG SIGN(21)					
								SF	SF	EA	EA	EA	EA	EA	EA	EA	EA	EA	EA	EA	EA	EA	EA	FILE NAME: East Montpelier.xls					
																							DESIGNED BY: M. Miller						
																							PROJECT MANAGER: N. Avery						
																							PLOT DATE: 6/18/2009						
																							DRAWN BY: T. Guazzoni						
																							CHECKED BY: S. Menard						
																							SHEET 138 OF 162						

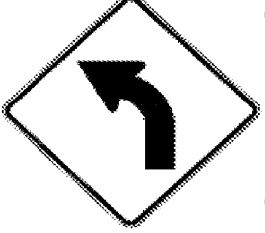
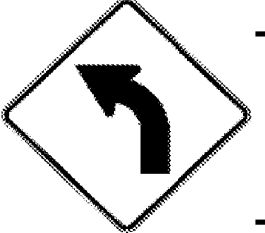



DIRECTION	MILEPOINT	LOCATION CODE (SHEET 2)	SIGN CODE	WIDTH (IN)	HEIGHT (IN)	SHEETING REMARKS	SIGN LEGEND FOR ALL POST LENGTHS AND INSTALLATION DATES SEE ORIGINAL RECORD PLANS	NEW SIGNS		EXISTING SIGNS				EXIST POST		NUMBER OF NEW POSTS	SQUARE STEEL (IN) (LB / FT)			TUBULAR STEEL Ø (IN) (LB / FT)				SIGN FRAME REQUIRED	REMARKS	SIGN DETAIL			
								"A"	"B"	RETAIN	SALVAGE FROM	SALVAGE TO	REMOVE	RETAIN	REMOVE		1.75	2.00	2.50	FOUNDATION	3.00	3.50	4.00			5.00	DETAIL IN SHS	DETAIL ON SHEET NUMBER	DETAIL ON STD SHEET NUMBER
E MONTPELIER VT 14							FY-FLUORESCENT YELLOW FYG-FLUORESCENT YELLOW GREEN															"SHS"-STANDARD HIGHWAY SIGNS							
NB	2.150	A	R2-1	24	30		SPEED LIMIT 35			1												SIGN TO BE SALVAGED TO LOCATION ACROSS THE ROAD AT SB MP 2.01							
NB	2.180	C	VR-017	24	30																								
		C	VR-017	24	30			5.00 6.25							1			X					TH-7, PAULS SQ			E-141			
NB	2.160	D	R1-1	30	30																								
		D	R1-1	30	30			6.25							1			X					TH-7, PAULS SQ	X					
NB	2.200	A	W7-1	30	30		HILL SYMBOL 																						
		A	W1-2L	30	30			6.25							1			X						X					
		A	W7-1B	30	30			6.25																X					
NB	2.260	A	VD-062A	72	16		BUSINESS SIGN			1																			
NB	2.265 TO 2.275	A		6	8		4 WHITE DELINEATORS	1.33							2			X					INSTALL BACK TO BACK EVENLY SPACED BETWEEN BUSINESS SIGN AND GUARDRAIL END			5			
NB	2.300	A	VD-018	30	18																								
		A	VD-018	30	18			3.75							1			X								E-128A			
NB	2.330	A	W3-1	30	30																								
		A	W3-1	36	36			9.00							2			X						X					
NB	2.390	A	M2-1	21	15																								
SIGN SUMMARY SHEET							SHEET TOTALS	37.83 39.08	0.00	1	1	0	6	0	0	8	120						PROJECT NAME: Hartford-East Montpelier VT14 PROJECT NUMBER: STPG SIGN(21)						
VERMONT AGENCY OF TRANSPORTATION							TOWN TOTALS	803.2	0.0	27.0	3.0	3.0	149	0.0	0.0	132	1980.0						FILE NAME: East Montpelier.xls PROJECT MANAGER: N. Avery DESIGNED BY: M. Miller EAST MONTPELIER SHEET 5						
																						PLOT DATE: 6/18/2009 DRAWN BY: T. Guazzoni CHECKED BY: S. Menard SHEET 140 OF 162							



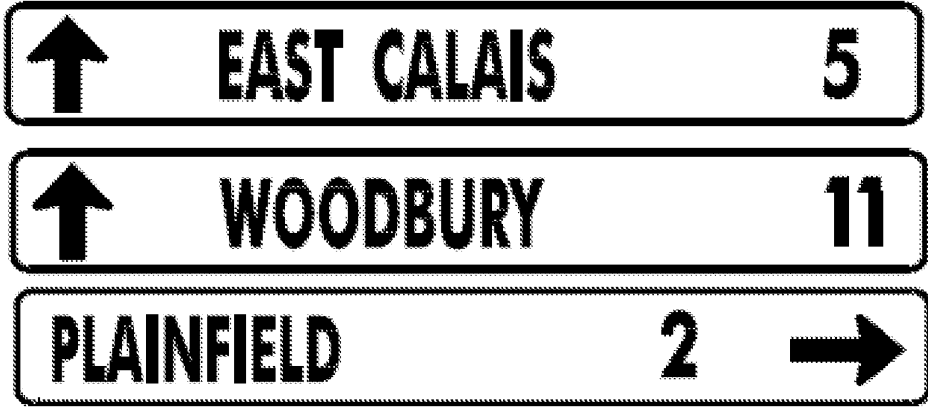

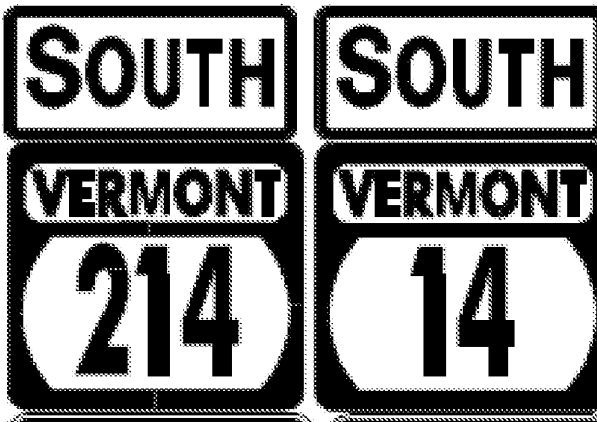

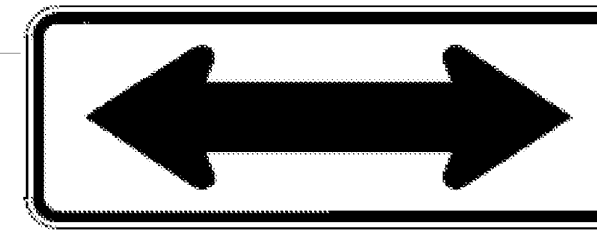

DIRECTION	MILEPOINT	LOCATION CODE (SHEET 2)	SIGN CODE	WIDTH (IN)	HEIGHT (IN)	SHEETING REMARKS	SIGN LEGEND FOR ALL POST LENGTHS AND INSTALLATION DATES SEE ORIGINAL RECORD PLANS	NEW SIGNS		EXISTING SIGNS				EXIST POST		NUMBER OF NEW POSTS	SQUARE STEEL (IN)			TUBULAR STEEL Ø (IN)				SIGN FRAME REQUIRED	REMARKS	SIGN DETAIL			
								"A"	"B"	RETAIN	SALVAGE FROM	SALVAGE TO	REMOVE	RETAIN	REMOVE		1.75	2.00	2.50	FOUNDATION	3.00	3.50	4.00			5.00	DETAIL IN SHS	DETAIL ON SHEET NUMBER	DETAIL ON STD SHEET NUMBER
																	(LB / FT)				(LB / FT)								
E MONTPELIER VT 14							FY-FLUORESCENT YELLOW FYG-FLUORESCENT YELLOW GREEN															"SHS"-STANDARD HIGHWAY SIGNS							
NB	2.530	A	W11-8	30	30																		VT 14 RESUMES						
		A	W11-2	30	30																								
		A	W11-8	30	30	FY																			X				
		A	W11-2	30	30	FY																			X				
NB	2.580	A	M3-1	24	12																								
		A	M1-5A	24	24																								
		A	M3-1	24	12																				X				
		A	M1-5	24	24																					E-136B			
NB	2.740	A	R2-1	24	30		SPEED LIMIT 40			1																			
NB	2.780	A	W1-4L	30	30		LEFT REVERSE CURVE			1																			
NB	2.940	A	W1-2R	30	30		RIGHT CURVE			1																			
		A	W13-1	18	18		40 MPH PLAQUE			1																			
NB	2.990	A	R2-1	24	30		SPEED LIMIT 50			1																			
NB	3.120	A	W11-3A	30	30		DEER CROSSING			1																			
		A	W7-3A	24	18		NEXT 2 MILES			1																			
SIGN SUMMARY SHEET							SHEET TOTALS	18.50	0.00	7	0	0	4 -2	0	0	3	45					PROJECT NAME: Hartford-East Montpelier VT14							
VERMONT AGENCY OF TRANSPORTATION							TOWN TOTALS	803.2	0.0	27.0	3.0	3.0	149	0.0	0.0	132	1980.0					PROJECT NUMBER: STPG SIGN(21)							
								SF	SF	EA	EA	EA	EA	EA	EA	EA	FT					FILE NAME: East Montpelier.xls	PLOT DATE: 6/18/2009						
																						PROJECT MANAGER: N. Avery	DRAWN BY: T. Guazzoni						
																						DESIGNED BY: M. Miller	CHECKED BY: S. Menard						
																						EAST MONTPELIER SHEET 8	SHEET 143 OF 162						





DIRECTION	MILEPOINT	LOCATION CODE (SHEET 2)	SIGN CODE	WIDTH (IN)	HEIGHT (IN)	SHEETING REMARKS	SIGN LEGEND FOR ALL POST LENGTHS AND INSTALLATION DATES SEE ORIGINAL RECORD PLANS	NEW SIGNS		EXISTING SIGNS				EXIST POST		NUMBER OF NEW POSTS	SQUARE STEEL (IN)			TUBULAR STEEL Ø (IN)				SIGN FRAME REQUIRED	REMARKS	SIGN DETAIL				
								"A"	"B"	RETAIN	SALVAGE FROM	SALVAGE TO	REMOVE	RETAIN	REMOVE		1.75	2.00	2.50	FOUNDATION	3.00	3.50	4.00			5.00	DETAIL IN SHS	DETAIL ON SHEET NUMBER	DETAIL ON STD SHEET NUMBER	
																	(LB / FT)				(LB / FT)									
E MONTPELIER VT 14							FY-FLUORESCENT YELLOW FYG-FLUORESCENT YELLOW GREEN															"SHS"-STANDARD HIGHWAY SIGNS								
NB	3.860	A	W1-2R	30	30			6.25										X						INSTALL 150 FT +/- SOUTH OF DRIVEWAY	X					
NB	3.920	A	W2-2R	30	30		RIGHT SIDE RD WARNING																							
NB	3.980	A	W1-10L	30	30			6.25										X							INSTALL 250 FT +/- NORTH OF EXISTING SIDE RD WARNING (TO BE REMOVED)	X				
		A	W16-8	24	8			1.33																	DAGGETT RD		7			
NB	4.015	C	W14-2	30	30																									
		C	W14-2	30	30			6.25										X									X			
NB	4.018	C	VR-017	24	30																									
		C	VR-017	24	30			5.00										X							TH-40, DAGGETT RD			E-141		
NB	4.025	D	R1-1	30	30																									
		D	R1-1	30	30			6.25										X							TH-40, DAGGETT RD	X				
NB	4.110	A	W11-6H	30	30																									
		A	W11-6H	30	30		HINGED	6.25										X							INSTALL IN CLOSED POSITION			E-153		
NB	4.485	A	S1-1YG	36	36		SCHOOL AHEAD				1																			
		A	W16-9YG	30	18		AHEAD				1																			
NB	4.550	A	D1-1E	72	20		SCHOOL D-BOARD				1																			
SIGN SUMMARY SHEET							SHEET TOTALS	37.58	0.00	1	2	0	5	0	0	6	90													
VERMONT AGENCY OF TRANSPORTATION								SF	SF	EA	EA	EA	EA	EA	EA	EA	EA	FT												
							TOWN TOTALS	803.2	0.0	27.0	3.0	3.0	149	0.0	0.0	132	1980.0													
PROJECT NAME: Hartford-East Montpelier VT14																					PROJECT NUMBER: STPG SIGN(21)									
FILE NAME: East Montpelier.xls												PLOT DATE: 6/18/2009																		
PROJECT MANAGER: N. Avery												DRAWN BY: T. Guazzoni																		
DESIGNED BY: M. Miller												CHECKED BY: S. Menard																		
EAST MONTPELIER SHEET 9																					SHEET 144 OF 162									





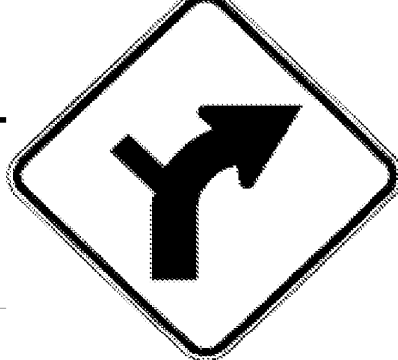
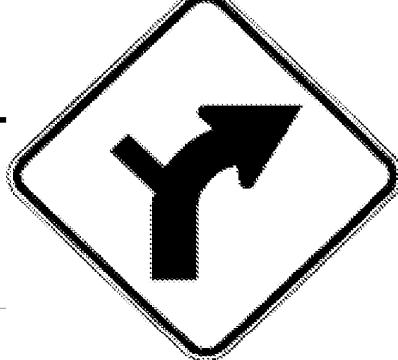

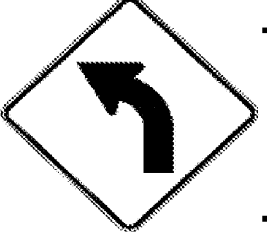
DIRECTION	MILEPOINT	LOCATION CODE (SHEET 2)	SIGN CODE	WIDTH (IN)	HEIGHT (IN)	SHEETING REMARKS	SIGN LEGEND FOR ALL POST LENGTHS AND INSTALLATION DATES SEE ORIGINAL RECORD PLANS	NEW SIGNS		EXISTING SIGNS				EXIST POST		NUMBER OF NEW POSTS	SQUARE STEEL (IN) (LB / FT)			TUBULAR STEEL Ø (IN) (LB / FT)				SIGN FRAME REQUIRED	REMARKS	SIGN DETAIL					
								"A"	"B"	RETAIN	SALVAGE FROM	SALVAGE TO	REMOVE	RETAIN	REMOVE		1.75	2.00	2.50	FOUNDATION	3.00	3.50	4.00			5.00	DETAIL IN SHS	DETAIL ON SHEET NUMBER	DETAIL ON STD SHEET NUMBER		
																														1.88	2.42
E MONTPELIER VT 14							FY-FLUORESCENT YELLOW FYG-FLUORESCENT YELLOW GREEN															"SHS"-STANDARD HIGHWAY SIGNS									
NB	4.595	A	S1-1YG	36	36		SCHOOL AHEAD																				INSTALL 225' +/- NORTH OF SCHOOL D-BOARD AT FENCE CORNER				
		A	W16-9YG	30	18		AHEAD																								
NB	4.635	C	VR-017	24	30																										
		C	VR-017	24	30			5.00																			TH-30, COBURN RD			E-141	
NB	4.645	D	R1-1	30	30																										
		D	R1-1	30	30			6.25																			TH-30, COBURN RD	X			
NB	4.870	A	W1-2L	30	30			6.25																			INSTALL BEHIND NORTH END OF GUARDRAIL SECTION	X			
NB	5.090	A	W1-2L	30	30			6.25																			INSTALL 150 FT +/- SOUTH OF DRIVEWAY	X			
NB	5.140	A	R2-5A	24	30		REDUCED SPEED AHEAD																								
		A	W3-5	36	36			9.00																						X	
NB	5.180	A	W11-7	30	30																										
		A	W11-7	30	30			6.25																						X	
NB	5.245	A	VD-018	30	18			3.75																			INSTALL 50 FT +/- SOUTH OF EXISTING, AWAY FROM LILACS			E-128A	
NB	5.255	A	VD-018	30	18		VILLAGE SIGN																								
NB	5.300	A	R2-1	24	30																										
SIGN SUMMARY SHEET							SHEET TOTALS	42.75	0.00	0	1	2	6	0	0	10	150														
VERMONT AGENCY OF TRANSPORTATION								SF	SF	EA	EA	EA	EA	EA	EA	EA	EA	EA	EA	EA	EA	EA	EA	EA	EA	EA	EA	EA	EA	EA	EA
TOWN TOTALS							803.2	0.0	27.0	3.0	3.0	149	0.0	0.0	132	1980.0															
PROJECT NAME: Hartford-East Montpelier VT14																					PROJECT NUMBER: STPG SIGN(21)										
FILE NAME: East Montpelier.xls												PLOT DATE: 6/18/2009																			
PROJECT MANAGER: N. Avery												DRAWN BY: T. Guazzoni																			
DESIGNED BY: M. Miller												CHECKED BY: S. Menard																			
EAST MONTPELIER SHEET 10												SHEET 145 OF 162																			







DIRECTION	MILEPOINT	LOCATION CODE (SHEET 2)	SIGN CODE	WIDTH (IN)	HEIGHT (IN)	SHEETING REMARKS	SIGN LEGEND FOR ALL POST LENGTHS AND INSTALLATION DATES SEE ORIGINAL RECORD PLANS	NEW SIGNS		EXISTING SIGNS				EXIST POST		NUMBER OF NEW POSTS	SQUARE STEEL (IN) (LB / FT)			TUBULAR STEEL Ø (IN) (LB / FT)				SIGN FRAME REQUIRED	REMARKS	SIGN DETAIL			
								"A"	"B"	RETAIN	SALVAGE FROM	SALVAGE TO	REMOVE	RETAIN	REMOVE		1.75	2.00	2.50	FOUNDATION	3.00	3.50	4.00			5.00	DETAIL IN SHS	DETAIL ON SHEET NUMBER	DETAIL ON STD SHEET NUMBER
																	1.88	2.42	3.35		7.60	9.00	10.80			14.60			
E MONTPELIER VT 14							FY-FLUORESCENT YELLOW FYG-FLUORESCENT YELLOW GREEN															"SHS"-STANDARD HIGHWAY SIGNS							
		A	R2-1	24	30			5.00							1		X							X					
NB	5.360	A	M2-1	21	15																								
		A	M1-5	30	24																								
		A	M2-1	21	15			2.19							1		X								X				
		A	M1-5	30	24			5.00																			E-136B		
NB	5.395	A	W11-2	30	30																								
		A	W11-2	30	30	FYG		6.25							1		X							X					
NB	5.430	A	D1-1A	72	12																								
		A	D1-1A	72	12																								
		A	D1-1A	72	12																								
		A	D1-1A	72	12			6.00							2		X										5		
		A	D1-1A	72	12			6.00																			5		
		A	D1-1A	72	12			6.00																			5		
NB	5.485	A	M3-1	24	12																								
		A	M1-5	24	24																								
SIGN SUMMARY SHEET							SHEET TOTALS	36.44	0.00	0	0	0	0	0	0	0	0	0	0	0	0	0	0	0	0	0	0	0	
VERMONT AGENCY OF TRANSPORTATION							TOWN TOTALS	803.2	0.0	27.0	3.0	3.0	149	0.0	0.0	132		1980.0											
															PROJECT NAME:	Hartford-East Montpelier VT14													
															PROJECT NUMBER:	STPG SIGN(21)													
															FILE NAME:	East Montpelier.xls						PLOT DATE:	6/18/2009						
															PROJECT MANAGER:	N. Avery						DRAWN BY:	T. Guazzoni						
															DESIGNED BY:	M. Miller						CHECKED BY:	S. Menard						
															EAST MONTPELIER SHEET 11	SHEET 146 OF 162													



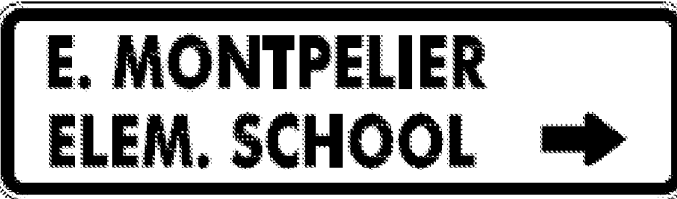



DIRECTION	MILEPOINT	LOCATION CODE (SHEET 2)	SIGN CODE	WIDTH (IN)	HEIGHT (IN)	SHEETING REMARKS	SIGN LEGEND FOR ALL POST LENGTHS AND INSTALLATION DATES SEE ORIGINAL RECORD PLANS	NEW SIGNS		EXISTING SIGNS				EXIST POST		NUMBER OF NEW POSTS	SQUARE STEEL (IN) (LB / FT)			TUBULAR STEEL Ø (IN) (LB / FT)				SIGN FRAME REQUIRED	REMARKS	SIGN DETAIL			
								"A"	"B"	RETAIN	SALVAGE FROM	SALVAGE TO	REMOVE	RETAIN	REMOVE		1.75	2.00	2.50	FOUNDATION	3.00	3.50	4.00			5.00	DETAIL IN SHS	DETAIL ON SHEET NUMBER	DETAIL ON STD SHEET NUMBER
																	1.88	2.42	3.35		7.60	9.00	10.80			14.60			
E MONTPELIER VT 14							FY-FLUORESCENT YELLOW FYG-FLUORESCENT YELLOW GREEN															"SHS"-STANDARD HIGHWAY SIGNS							
		F	M3-3	24	12			2.00															GREEN ON WHITE SHEETING	X					
		F	M1-5	24	24				4.00																E-136B				
		F	M6-3	21	15				2.19															GREEN ON WHITE SHEETING	X				
SB	5.560	G	W1-7	48	24							1			X														
		G	W1-7	48	24	FY			8.00							2		X						X					
SB	5.555	F	M3-3	24	12		SOUTH																						
		F	M1-5	24	24		VT 14																						
SB	5.510	F	D2-1	72	12		E MONTPELIER 3																						
		F	D2-1	72	12		MONTPELIER 10																						
SB	5.500	G	VR-017	24	30																								
		G	VR-017	24	30				5.00							1		X						TH-11, FACTORY ST		E-141			
SB	5.495	H	R1-1	30	30																								
		H	R1-1	30	30				6.25							1		X						TH-11, FACTORY ST	X				
SB	5.475	F	D2-1	72	12			6.00															INSTALL 100 FT +/- SOUTH OF FACTORY ST		5				
		F	D2-1	72	12			6.00																5					
SIGN SUMMARY SHEET							SHEET TOTALS	39.44	0.00	0	0	0	7	0	0	6		90					PROJECT NAME: Hartford-East Montpelier VT14						
VERMONT AGENCY OF TRANSPORTATION							TOWN TOTALS	803.2	0.0	27.0	3.0	3.0	149	0.0	0.0	132		1980.0				PROJECT NUMBER: STPG SIGN(21)	FILE NAME: East Montpelier.xls	PLOT DATE: 6/18/2009					
								SF	SF	EA	EA	EA	EA	EA	EA	EA	FT					PROJECT MANAGER: N. Avery	DRAWN BY: T. Guazzoni						
																					DESIGNED BY: M. Miller	CHECKED BY: S. Menard							
																					EAST MONTPELIER SHEET 15	SHEET 150 OF 162							





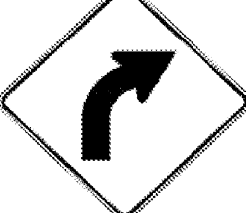

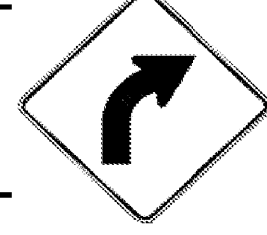
DIRECTION	MILEPOINT	LOCATION CODE (SHEET 2)	SIGN CODE	WIDTH (IN)	HEIGHT (IN)	SHEETING REMARKS	SIGN LEGEND FOR ALL POST LENGTHS AND INSTALLATION DATES SEE ORIGINAL RECORD PLANS	NEW SIGNS		EXISTING SIGNS				EXIST POST		NUMBER OF NEW POSTS	SQUARE STEEL (IN) (LB / FT)			TUBULAR STEEL Ø (IN) (LB / FT)				SIGN FRAME REQUIRED	REMARKS	SIGN DETAIL			
								"A"	"B"	RETAIN	SALVAGE FROM	SALVAGE TO	REMOVE	RETAIN	REMOVE		1.75	2.00	2.50	FOUNDATION	3.00	3.50	4.00			5.00	DETAIL IN SHS	DETAIL ON SHEET NUMBER	DETAIL ON STD SHEET NUMBER
																	1.88	2.42	3.35		7.60	9.00	10.80			14.60			
E MONTPELIER VT 14							FY-FLUORESCENT YELLOW FYG-FLUORESCENT YELLOW GREEN															"SHS"-STANDARD HIGHWAY SIGNS							
			F M3-3	24	12			2.00															GREEN ON WHITE SHEETING. INSTALL ROUTE MARKERS ON LEFT POST BELOW D- BOARDS	X					
			F M1-5	24	24			4.00																	E-136B				
SB	5.320		F R2-1	24	30								1			X													
			F R2-1	24	30			5.00							1		X							X					
SB	5.060		F W11-3A	30	30								1			X													
			F W7-3A	24	18								1																
			F W11-3A	30	30			6.25							1		X								6				
			F W7-3A	24	18			3.00																X					
SB	4.815		F S1-1YG	36	36		SCHOOL AHEAD			1						X													
			F W16-9YG	30	18		AHEAD			1																			
SB	4.771		F D1-1E	72	20		SCHOOL D-BOARD			1						X													
SB	4.740		G VR-017	24	30								1			X													
			G VR-017	24	30			5.00							1		X						TH-26, HAMMETT HILL RD		E-141				
SB	4.730		H R1-1	30	30						1					X													
			H R1-1	30	30			6.25							1		X						TH-26, HAMMETT HILL RD	X					
SIGN SUMMARY SHEET							SHEET TOTALS	31.50	0.00	3	0	0	5	0	0	4	60						PROJECT NAME: Hartford-East Montpelier VT14						
VERMONT AGENCY OF TRANSPORTATION							TOWN TOTALS	803.2	0.0	27.0	3.0	3.0	149	0.0	0.0	132	1980.0						PROJECT NUMBER: STPG SIGN(21)						
								SF	SF	EA	EA	EA	EA	EA	EA	EA	FT						FILE NAME: East Montpelier.xls	PLOT DATE: 6/18/2009					
																						PROJECT MANAGER: N. Avery	DRAWN BY: T. Guazzoni						
																						DESIGNED BY: M. Miller	CHECKED BY: S. Menard						
																						EAST MONTPELIER SHEET 16	SHEET 151 OF 162						

DIRECTION	MILEPOINT	LOCATION CODE (SHEET 2)	SIGN CODE	WIDTH (IN)	HEIGHT (IN)	SHEETING REMARKS	SIGN LEGEND FOR ALL POST LENGTHS AND INSTALLATION DATES SEE ORIGINAL RECORD PLANS	NEW SIGNS		EXISTING SIGNS				EXIST POST		NUMBER OF NEW POSTS	SQUARE STEEL (IN)			TUBULAR STEEL Ø (IN)				SIGN FRAME REQUIRED	REMARKS	SIGN DETAIL				
								"A"	"B"	RETAIN	SALVAGE FROM	SALVAGE TO	REMOVE	RETAIN	REMOVE		1.75	2.00	2.50	FOUNDATION	3.00	3.50	4.00			5.00	DETAIL IN SHS	DETAIL ON SHEET NUMBER	DETAIL ON STD SHEET NUMBER	
																	(LB / FT)				(LB / FT)									
E MONTPELIER VT 14							FY-FLUORESCENT YELLOW FYG-FLUORESCENT YELLOW GREEN															"SHS"-STANDARD HIGHWAY SIGNS								
SB	4.360	F	W11-6H	30	30																									
		F	W11-6H	30	30	HINGED		6.25																		INSTALL IN CLOSED POSITION			E-153	
SB	4.240	F	S3-1	30	30	SCHOOL BUS STOP AHEAD																								
SB	4.105	F	R1-10R	30	30			6.25																		INSTALL 25 FT +/- SOUTH OF DRIVEWAY	X			
		F	W16-8	24	8			1.33																			DAGGETT RD			7
SB	4.000	F	R2-1L	30	30			6.25																			INSTALL 150 FT +/- SOUTH OF DAGGETT RD	X		
SB	3.360	F	S3-1	30	30	SCHOOL BUS STOP AHEAD				0	1	1																		
SB	3.150	F	W1-4L	30	30	REVERSE CURVE				1																				
		F	W13-1	18	18	40 MPH PLAQUE				1																				
SB	3.070	F	W3-5	36	36	SPEED REDUCTION 40 MPH				1																				
SB	3.060 TO 3.000	A	N/A	6	8	8 WHITE DELINEATORS		2.66																			INSTALL BACK TO BACK AT 100' SPACING, START 50 FT SOUTH OF SPEED WARNING SIGN			5
SB	2.990	F	R2-1	24	30																									
		F	R2-1	30	36			7.50																						
SB	2.950	F	S3-1	30	30	SCHOOL BUS STOP AHEAD				1																				
		F	VW-060	30	30	HIDDEN DRIVES				1																				
SIGN SUMMARY SHEET							SHEET TOTALS	30.24	0.00	5	1	1	3	0	0	8	120						PROJECT NAME: Hartford-East Montpelier VT14 PROJECT NUMBER: STPG SIGN(21)							
VERMONT AGENCY OF TRANSPORTATION								SF	SF	EA	EA	EA	EA	EA	EA	EA	EA	FT						FILE NAME: East Montpelier.xls PLOT DATE: 6/18/2009 PROJECT MANAGER: N. Avery DRAWN BY: T. Guazzoni DESIGNED BY: M. Miller CHECKED BY: S. Menard EAST MONTPELIER SHEET 17 SHEET 152 OF 162						
							TOWN TOTALS	803.2	0.0	27.0	3.0	3.0	149	0.0	0.0	132	1980.0													

DIRECTION	MILEPOINT	LOCATION CODE (SHEET 2)	SIGN CODE	WIDTH (IN)	HEIGHT (IN)	SHEETING REMARKS	SIGN LEGEND	NEW SIGNS		EXISTING SIGNS				EXIST POST		NUMBER OF NEW POSTS	SQUARE STEEL (IN)			TUBULAR STEEL Ø (IN)				SIGN FRAME REQUIRED	REMARKS	SIGN DETAIL			
								"A"	"B"	RETAIN	SALVAGE FROM	SALVAGE TO	REMOVE	RETAIN	REMOVE		1.75	2.00	2.50	FOUNDATION	3.00	3.50	4.00			5.00	DETAIL IN SHS	DETAIL ON SHEET NUMBER	DETAIL ON STD SHEET NUMBER
																	(LB / FT)				(LB / FT)								
E MONTPELIER VT 14							FY-FLUORESCENT YELLOW FYG-FLUORESCENT YELLOW GREEN															"SHS"-STANDARD HIGHWAY SIGNS							
		G	VR-018	24	30			5.00							1		X						TH-39, KELTON RD			E-141			
SB	2.575	H	R1-1	30	30					1		1				X													
		H	R1-1	30	30			6.25			1				1		X						TH-39, KELTON RD	X					
SB	2.565	F	D1-1A	72	12							1				X													
		F	D1-1A	72	12							1																	
		F	D1-1A	72	12							1																	
		F	D1-1A	72	12							1																	
		F	D1-1A	72	12			6.00						2			X								5				
		F	D1-1A	72	12			6.00																	5				
		F	D1-1A	72	12			6.00																	5				
		F	D1-1A	72	12			6.00																	5				
SB	2.530	F	M3-2	24	12							1				X													
		F	M1-4	24	24							1																	
		F	M6-1	21	15							1																	
		F	M3-3	24	12							1																	
SIGN SUMMARY SHEET							SHEET TOTALS	35.25	0.00	0	0	0	9	0	0	4		60											
VERMONT AGENCY OF TRANSPORTATION								SF	SF	EA	EA	EA	EA	EA	EA	EA		FT											
							TOWN TOTALS	803.2	0.0	27.0	3.0	3.0	149	0.0	0.0	132		1980.0											
																	PROJECT NAME:	Hartford-East Montpelier VT14											
																	PROJECT NUMBER:	STPG SIGN(21)											
																	FILE NAME:	East Montpelier.xls				PLOT DATE:	6/18/2009						
																	PROJECT MANAGER:	N. Avery				DRAWN BY:	T. Guazzoni						
																	DESIGNED BY:	M. Miller				CHECKED BY:	S. Menard						
																	EAST MONTPELIER SHEET 19							SHEET	154		OF	162	

DIRECTION	MILEPOINT	LOCATION CODE (SHEET 2)	SIGN CODE	WIDTH (IN)	HEIGHT (IN)	SHEETING REMARKS	SIGN LEGEND FOR ALL POST LENGTHS AND INSTALLATION DATES SEE ORIGINAL RECORD PLANS	NEW SIGNS		EXISTING SIGNS				EXIST POST		NUMBER OF NEW POSTS	SQUARE STEEL (IN) (LB / FT)			TUBULAR STEEL Ø (IN) (LB / FT)				SIGN FRAME REQUIRED	REMARKS	SIGN DETAIL			
								"A"	"B"	RETAIN	SALVAGE FROM	SALVAGE TO	REMOVE	RETAIN	REMOVE		1.75	2.00	2.50	FOUNDATION	3.00	3.50	4.00			5.00	DETAIL IN SHS	DETAIL ON SHEET NUMBER	DETAIL ON STD SHEET NUMBER
E MONTPELIER VT 14							FY-FLUORESCENT YELLOW FYG-FLUORESCENT YELLOW GREEN															"SHS"-STANDARD HIGHWAY SIGNS							
		F	D1-2R	72	20			10.00										X							5				
SB	2.490	G	VR-017	24	30																								
		G	VR-017	24	30			5.00										X								E-141			
SB	2.480	H	R1-1	30	30						1																		
		H	R1-1	30	30			6.25										X						X					
																										VT 14 FOLLOWS US 2 FOR 0.2 MILES			
SB	2.455	E	R1-1	30	30																								
		E	R1-1	36	36			9.00										X						X		THIS STOP SIGN IS AT THE SOUTHERN INTERSECTION OF VT 14/US 2			
SB	2.450	F	OM-3R	12	36																								
		F	OM-3R	12	36			3.00										X						X					
SB	2.420	E	OM-3L	12	36		LEFT OBJECT MARKER			1																			
SB	2.415	F	R2-1	24	30																								
		F	R2-1	24	30			5.00										X						X					
SB	2.395	F	M3-3	24	12						1															CROSS VT TRAIL (SALV.)			
		F	M1-5	24	24																								
SIGN SUMMARY SHEET							SHEET TOTALS	38.25	0.00	1	2	1	7	0	0	8	120						PROJECT NAME: Hartford-East Montpelier VT14 PROJECT NUMBER: STPG SIGN(21)						
VERMONT AGENCY OF TRANSPORTATION								SF	SF	EA	EA	EA	EA	EA	EA	EA	FT						FILE NAME: East Montpelier.xls PLOT DATE: 6/18/2009 PROJECT MANAGER: N. Avery DRAWN BY: T. Guazzoni DESIGNED BY: M. Miller CHECKED BY: S. Menard EAST MONTPELIER SHEET 21 SHEET 156 OF 162						
							TOWN TOTALS	803.2	0.0	27.0	3.0	3.0	149	0.0	0.0	132	1980.0												

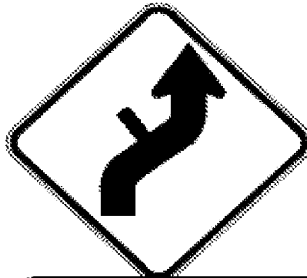
DIRECTION	MILEPOINT	LOCATION CODE (SHEET 2)	SIGN CODE	WIDTH (IN)	HEIGHT (IN)	SHEETING REMARKS	SIGN LEGEND FOR ALL POST LENGTHS AND INSTALLATION DATES SEE ORIGINAL RECORD PLANS	NEW SIGNS		EXISTING SIGNS				EXIST POST		NUMBER OF NEW POSTS	SQUARE STEEL (IN)			TUBULAR STEEL Ø (IN)				SIGN FRAME REQUIRED	REMARKS	SIGN DETAIL			
								"A"	"B"	RETAIN	SALVAGE FROM	SALVAGE TO	REMOVE	RETAIN	REMOVE		1.75	2.00	2.50	FOUNDATION	3.00	3.50	4.00			5.00	DETAIL IN SHS	DETAIL ON SHEET NUMBER	DETAIL ON STD SHEET NUMBER
																	(LB / FT)				(LB / FT)								
E MONTPELIER VT 14							FY-FLUORESCENT YELLOW FYG-FLUORESCENT YELLOW GREEN															"SHS"-STANDARD HIGHWAY SIGNS							
			F M3-3	24	12			2.00				1						X						GREEN ON WHITE SHEETING	X				
			F M1-5	24	24			4.00																		E-136B			
SB	2.320		F VW-205	30	30								1																
			F VW-205	30	30			6.25						1				X								E-154			
			F W11-7	30	30			6.25																X					
SB	2.310		F W11-7	30	30		EQUESTRIAN						1																
			F S3-1	30	30								1																
			F W1-2R	30	30			6.25							1			X						X					
			F S3-1	30	30			6.25																X					
SB	2.215		F W1-2R	30	30		RIGHT CURVE						1																
			F W1-2R	30	30			6.25							1			X								INSTALL 150 FT +/- SOUTH OF EXISTING	X		
SB	2.010		F R2-1	24	30		SPEED LIMIT 35						1																
			F R2-1	24	30		SPEED LIMIT 35							1				X								SIGN SALVAGED FROM NB MP 2.15			
SB	1.855		G VR-017	24	30								1																
			G VR-017	24	30			5.00										X								TH-60, LYLEHAVEN LANE		E-141	
SIGN SUMMARY SHEET							SHEET TOTALS	42.25	0.00	0	0	2	6	0	0	6		120											
VERMONT AGENCY OF TRANSPORTATION								SF	SF	EA	EA	EA	EA	EA	EA	EA		FT											
TOWN TOTALS							803.2	0.0	27.0	3.0	3.0	149	0.0	0.0	132		1980.0												
PROJECT NAME: Hartford-East Montpelier VT14																					PROJECT NUMBER: STPG SIGN(21)								
FILE NAME: East Montpelier.xls															PLOT DATE: 6/18/2009														
PROJECT MANAGER: N. Avery															DRAWN BY: T. Guazzoni														
DESIGNED BY: M. Miller															CHECKED BY: S. Menard														
EAST MONTPELIER SHEET 22															SHEET 157 OF 162														

DIRECTION	MILEPOINT	LOCATION CODE (SHEET 2)	SIGN CODE	WIDTH (IN)	HEIGHT (IN)	SHEETING REMARKS	SIGN LEGEND FOR ALL POST LENGTHS AND INSTALLATION DATES SEE ORIGINAL RECORD PLANS	NEW SIGNS		EXISTING SIGNS				EXIST POST		NUMBER OF NEW POSTS	SQUARE STEEL (IN) (LB / FT)			TUBULAR STEEL Ø (IN) (LB / FT)				SIGN FRAME REQUIRED	REMARKS	SIGN DETAIL			
								"A"	"B"	RETAIN	SALVAGE FROM	SALVAGE TO	REMOVE	RETAIN	REMOVE		1.75	2.00	2.50	FOUNDATION	3.00	3.50	4.00			5.00	DETAIL IN SHS	DETAIL ON SHEET NUMBER	DETAIL ON STD SHEET NUMBER
																	1.88	2.42	3.35		7.60	9.00	10.80			14.60			
E MONTPELIER VT 14							FY-FLUORESCENT YELLOW FYG-FLUORESCENT YELLOW GREEN															"SHS"-STANDARD HIGHWAY SIGNS							
SB	1.845	H	R1-1	30	30					1																			
		H	R1-1	30	30			6.25			1							X					TH-60, LYLEHAVEN LANE	X					
SB	1.800	F	R2-1	24	30					1																			
		F	R2-1	24	30			5.00			1							X						X					
SB	1.740	F	W11-6	30	30																								
		F	W11-6H	30	30			6.25										X					INSTALL IN CLOSED POSITION			E-153			
SB	1.690	F	W1-2MeR	30	30		RIGHT CURVE WITH WITH 2 SIDEROADS																						
		F	W13-1	18	18		35 MPH PLAQUE																						
		F	W1-10R	30	30			6.25											X					X					
		F	W16-8	24	8			1.33																		7			
SB	1.400	F	W1-4L	30	30		LEFT REVERSE CURVE																						
		F	W13-1	18	18		35 MPH PLAQUE																						
		F	W1-4MR	30	30			6.25											X							6			
		F	W16-8	30	8			1.67																		7			
SB	1.305	F	VD-062B	72	16		BUSINESS SIGN			1																			
SIGN SUMMARY SHEET							SHEET TOTALS	33.00	0.00	1	2	2	7	0	0	5	75							PROJECT NAME: Hartford-East Montpelier VT14 PROJECT NUMBER: STPG SIGN(21)					
VERMONT AGENCY OF TRANSPORTATION							TOWN TOTALS	803.2	0.0	27.0	3.0	3.0	149	0.0	0.0	132	1980.0						FILE NAME: East Montpelier.xls PROJECT MANAGER: N. Avery DESIGNED BY: M. Miller EAST MONTPELIER SHEET 23	PLOT DATE: 6/18/2009 DRAWN BY: T. Guazzoni CHECKED BY: S. Menard SHEET 158 OF 162					

TOWN TOTAL SIGN SUMMARY SHEET

VT ROUTE 14 Hartford - East Montpelier STPG SIGN (21)

Townname	County	Town Mileage	NEW SIGNS (SF)		EXISTING SIGNS (EA)				EXIST POST (EA)		NUMBER OF NEW POSTS (EA)			SQUARE STEEL (IN)			TUBULAR STEEL Ø (IN)					
			TYPE A	TYPE B	RETAIN	SALVAGE FROM	SALVAGE TO	REMOVE	RETAIN	REMOVE	1.75"	2"	2.5"	TOTAL POSTS	1.75	2.00	2.50	FOUNDATION	3.00	3.50	4.00	5.00
											(LB / FT)				(LB / FT)				(LB / FT)			
											1.88	2.42	3.35		1.88	2.42	3.35		7.60	9.00	10.80	14.60
Hartford	Windsor	7.856	130.20	0	41	13	9	26	0	0	0	26	0	390.00	0							
Sharon	Windsor	7.565	447.00	0	11	1	1	93	0	0	0	64	0	960.00	0							
Royalton	Windsor	9.121	973.50	0	62	9	9	190	0	0	0	152	0	2280.00	0							
Bethel	Windsor	0.89	99.80	0	0	0	0	20	0	0	0	17	0	255.00	0							
Randolph	Orange	7.734	771.40	0	19	5	5	155	0	0	0	128	2	1920.00	30							
Brookfield	Orange	6.677	332.40	0	2	0	0	50	0	0	0	45	4	675.00	60							
Williamstown	Orange	6.833	501.10	0	67	0	0	94	0	0	28	81	0	1215.00	0							
Barre (Town)	Washington	4.033	583.80	0	48	9	9	115	0	0	0	89	0	1335.00	0							
East Montpelier	Washington	5.821	803.20	0	27	3	3	149	0	0	6	120	6	1800.00	90							
Sub-Total						40	36	892						510	10830	180						
Estimated Salvaged Street Name Signs to be erected onto new posts =																						
Salvaged From signs to be added to Remove total =																						
TOTAL =			4642.4	0	277	40	61	932	0	0	34	722	12	768	510	10830	180	0	0	0	0	

SEE ADDITIONAL PAGE, THIS SHEET, FOR ACTUAL TOWN TOTALS.

PROJECT NAME: HARTFORD - EAST MONTPELIER
PROJECT NUMBER: STPG SIGN (21)

FILE NAME: 09c024_TS.DGN
PROJECT LEADER: N. AVERY
DESIGNED BY: N. AVERY
TOWN TOTAL SIGN SUMMARY SHEET

PLOT DATE: 23-JUN-2009
DRAWN BY: N. AVERY
CHECKED BY: A. GAMBLE
SHEET 160 OF 162

Town Mileage	NEW SIGNS (SF)		EXISTING SIGNS (EA)			EXIST POST (EA)		NUMBER OF NEW POSTS (EA)			SQUARE STEEL (IN)			TUBUL						
	TYPE A	TYPE B	RETAIN	SALVAGE FROM	SALVAGE TO	REMOVE	RETAIN	REMOVE	1.75"	2"	2.5"	TOTAL POSTS	1.75	2.00	2.50	FOUNDATION	3.			
									(LB / FT)				(LB / FT)				1.88	2.42	3.35	7.
									1.88	2.42	3.35									
Hartford 7.856	193.99	0	42	11	11	30	0	0	0	29	0	29	0	433.75	0					
Sharon 7.565	460.06	0	11	1	1	98	0	0	0	66	0	66	0	884.42	0					
Royalton 9.121	1061.55	0	61	10	10	197	0	0	0	166	0	166	0	2204.42	0					
Bethel 0.89	98.75	0	0	0	0	22	0	0	0	17	0	17	0	242.75	0					
Randolph 7.734	784.49	0	19	4	4	160	0	0	0	134	2	136	0	1801.25	30.50					
Brookfield 6.677	344.48	0	2	0	0	53	0	0	0	52	2	54	0	707.50	30.00					
Williamstown 6.833	505.56	0	67	0	0	97	0	0	0	110	0	110	0	1393.50	0					
Barre 4.033	590.46	0	48	23	23	117	0	0	0	88	0	88	0	1211.75	0					
E. Montpelier 5.821	800.65	0	25	15	15	162	0	0	0	130	6	136	0	1729.67	96.00					
Sub-Total				64	64	936								10,609.01	156.50					
Signs to be erected onto new posts =					25															
to Remove total =							64													
TOTAL =	4839.99	0	275	64	64	1000	0	0	0	792	10	802	0	10,609.01	156.50	0				

PLP
 6-4-11
JHS
 8-01-11