

CONTROL TIES

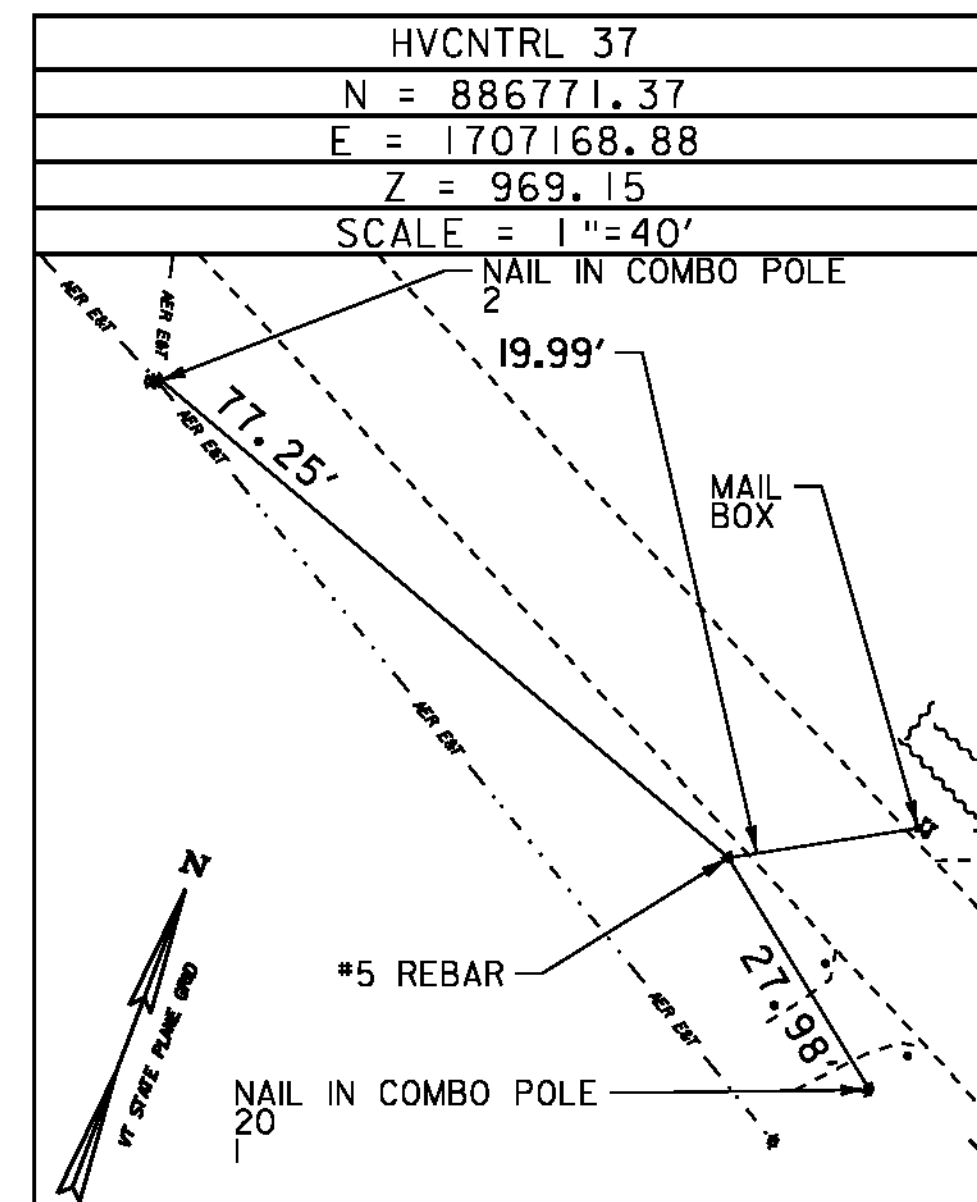
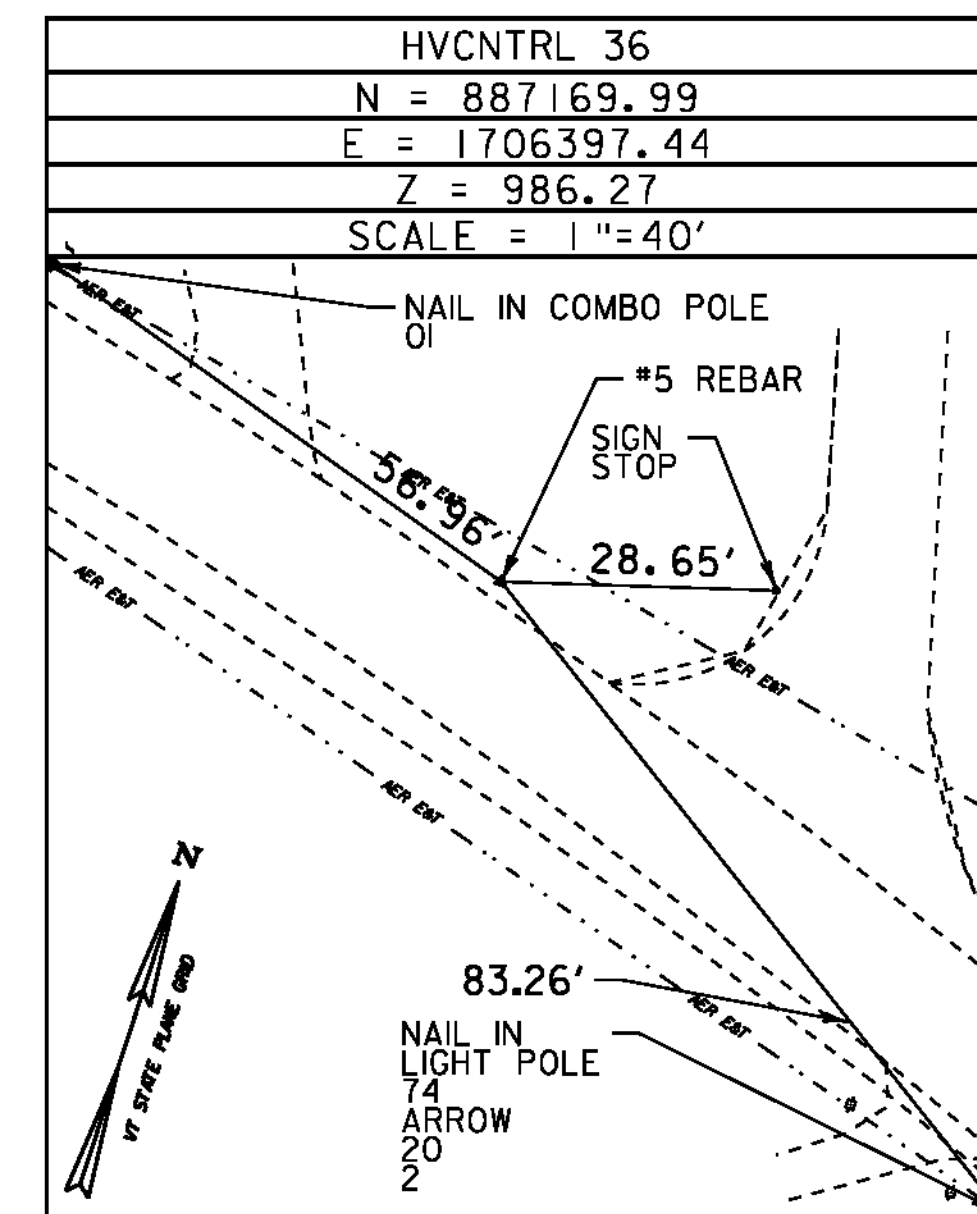
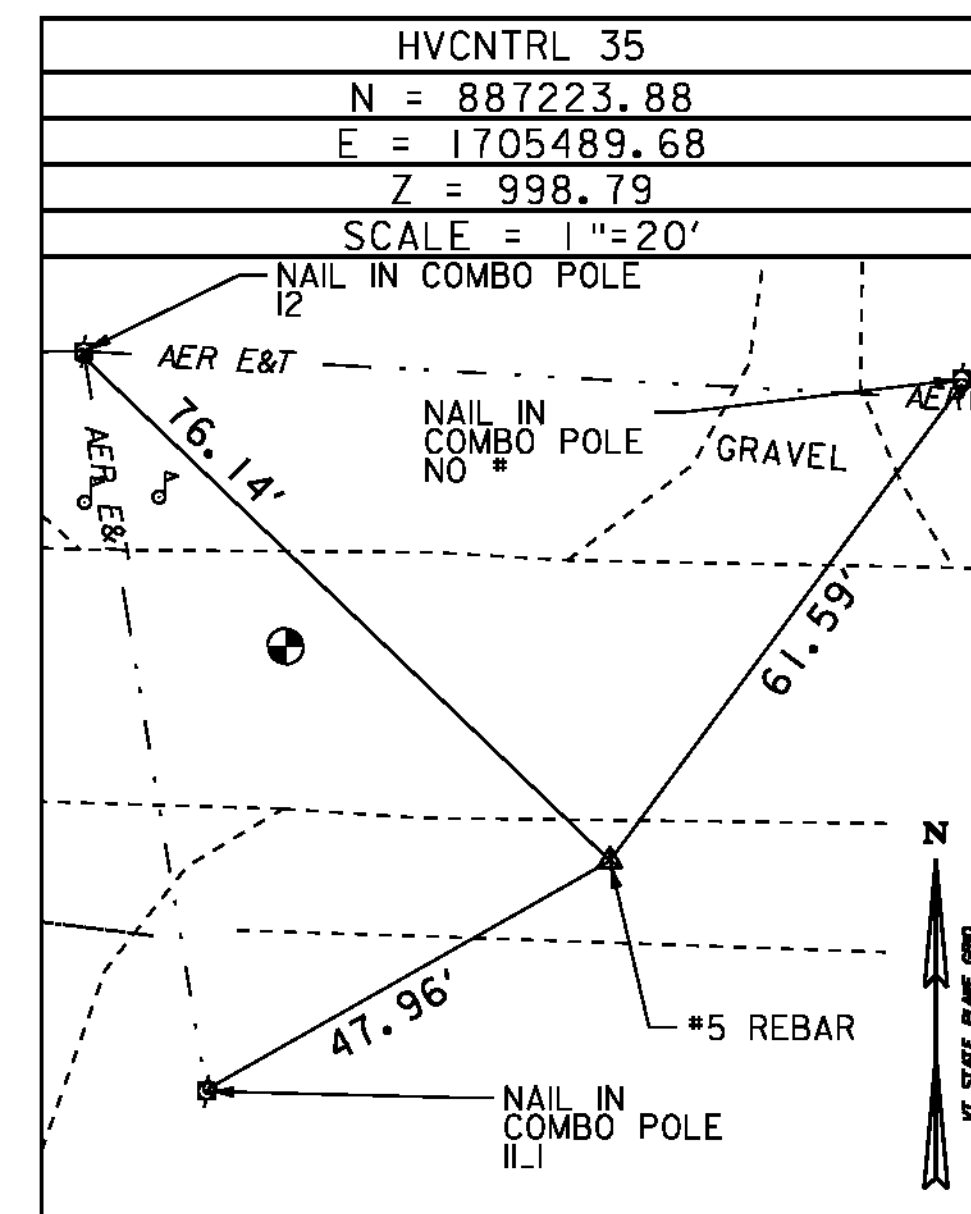
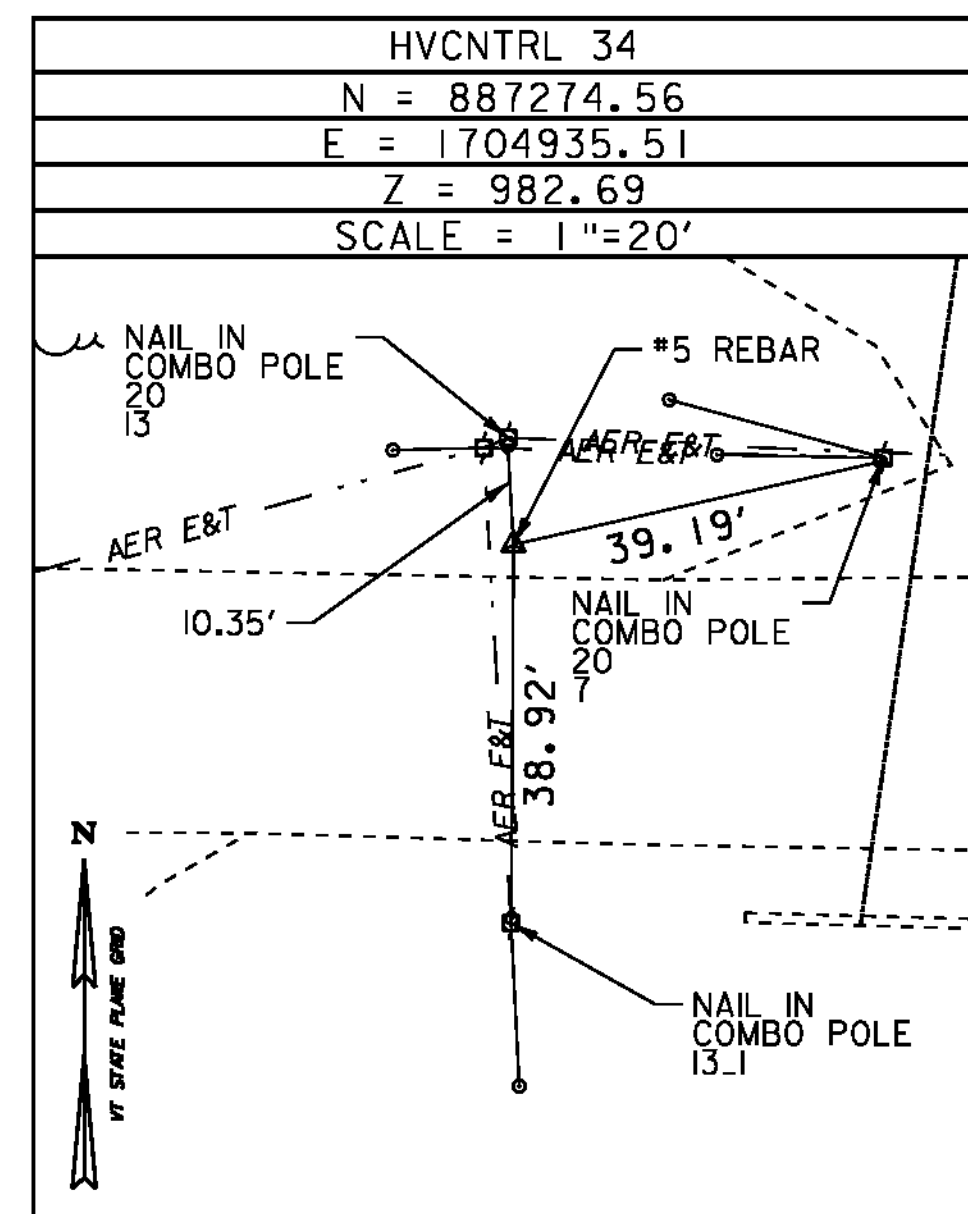
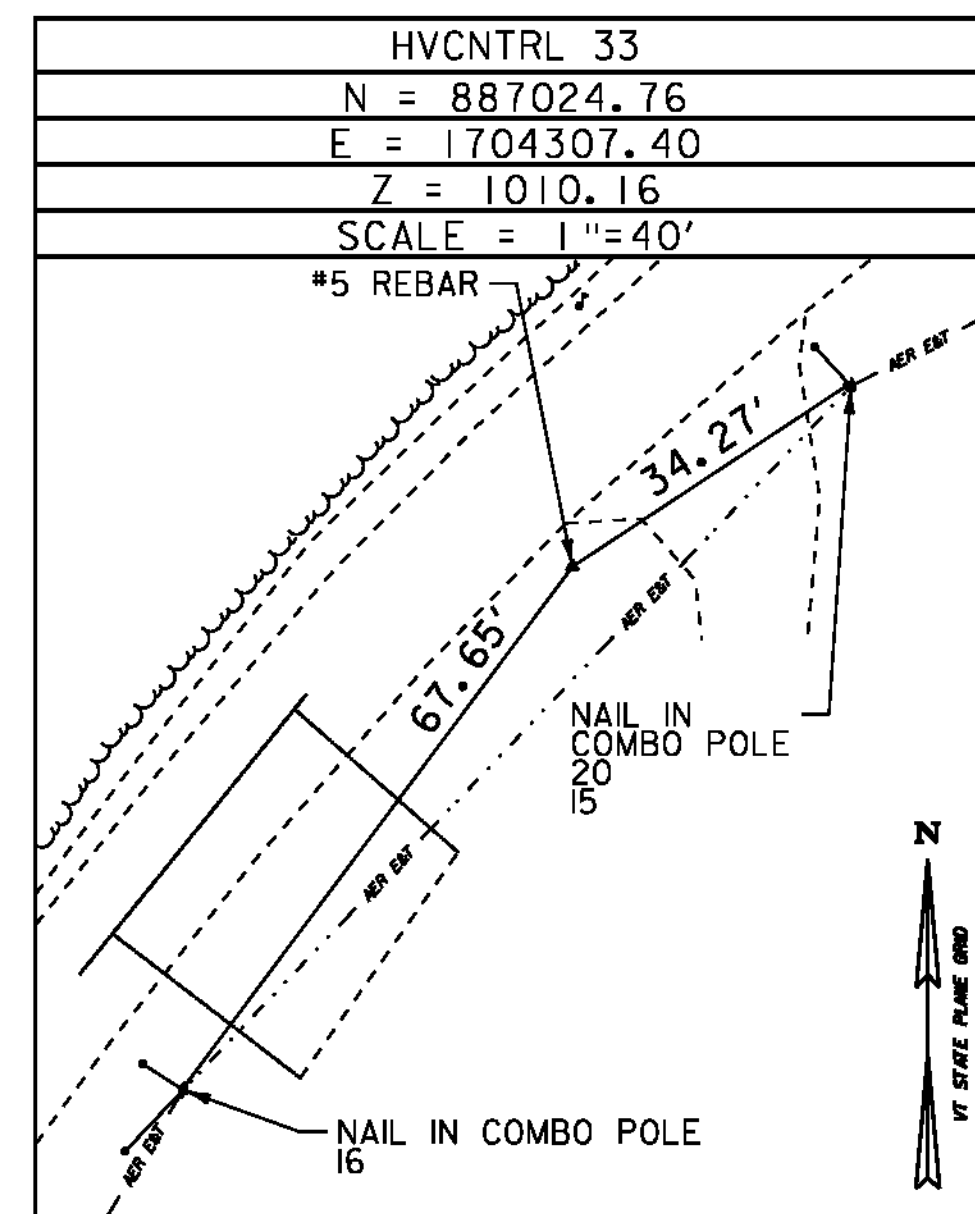
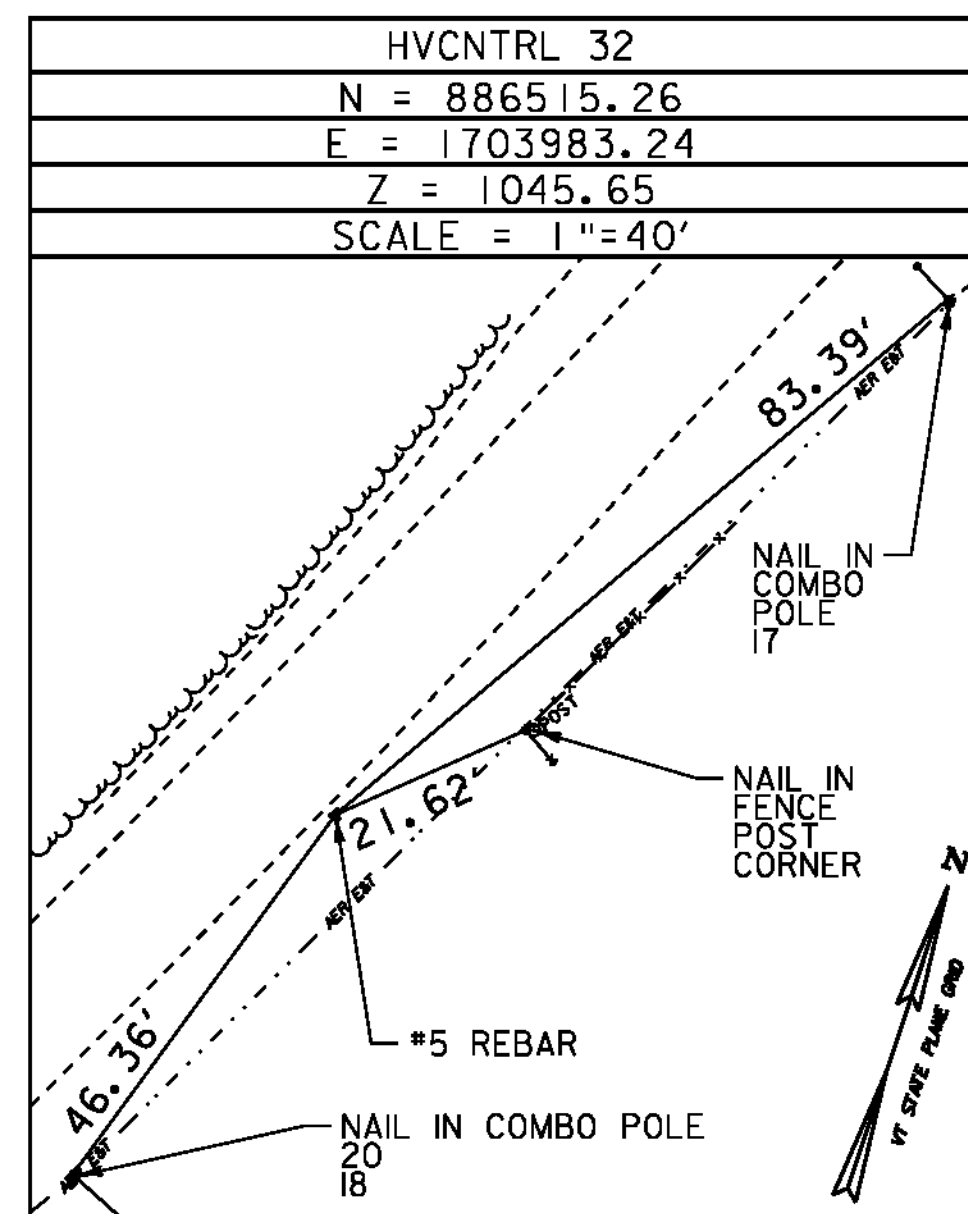
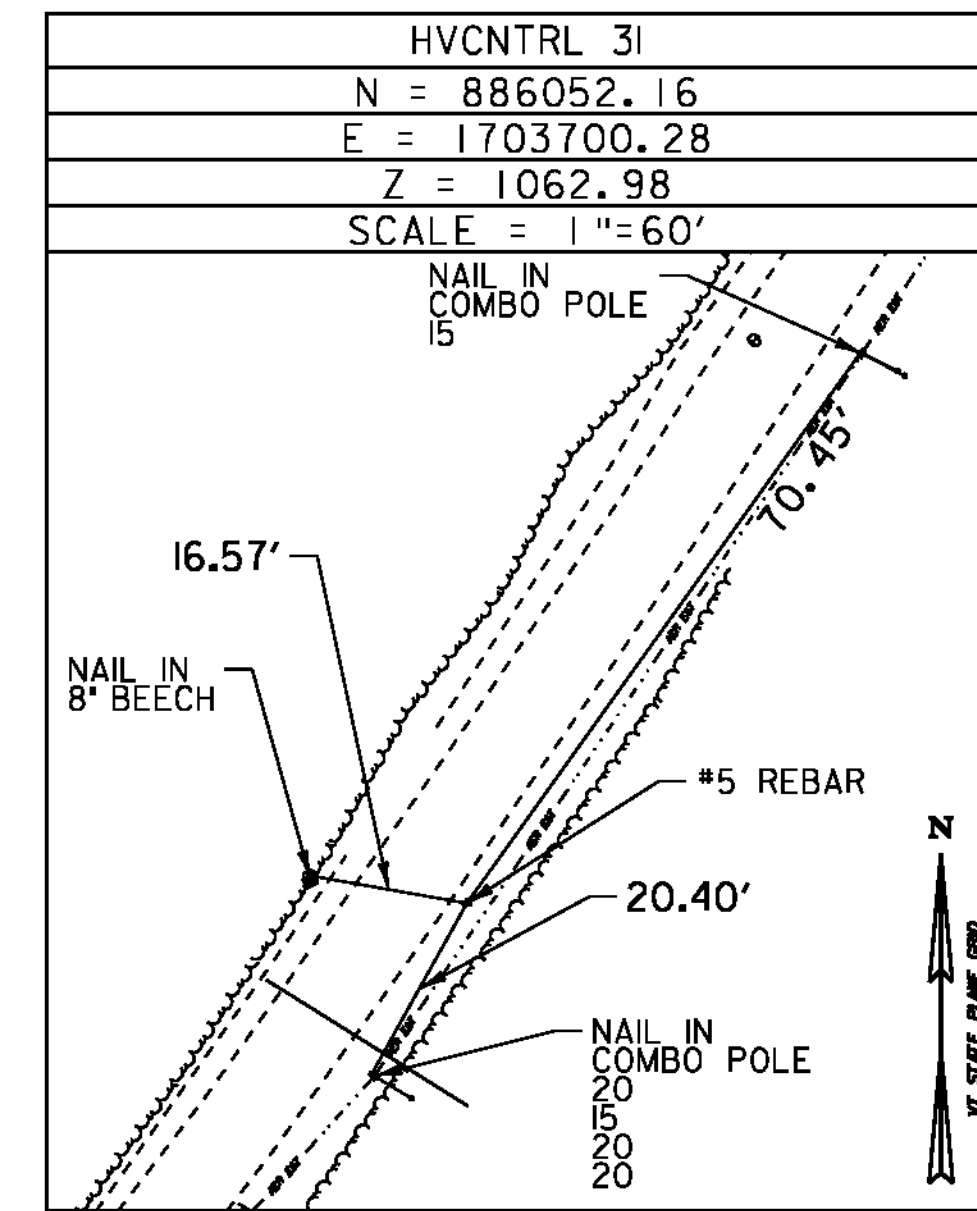
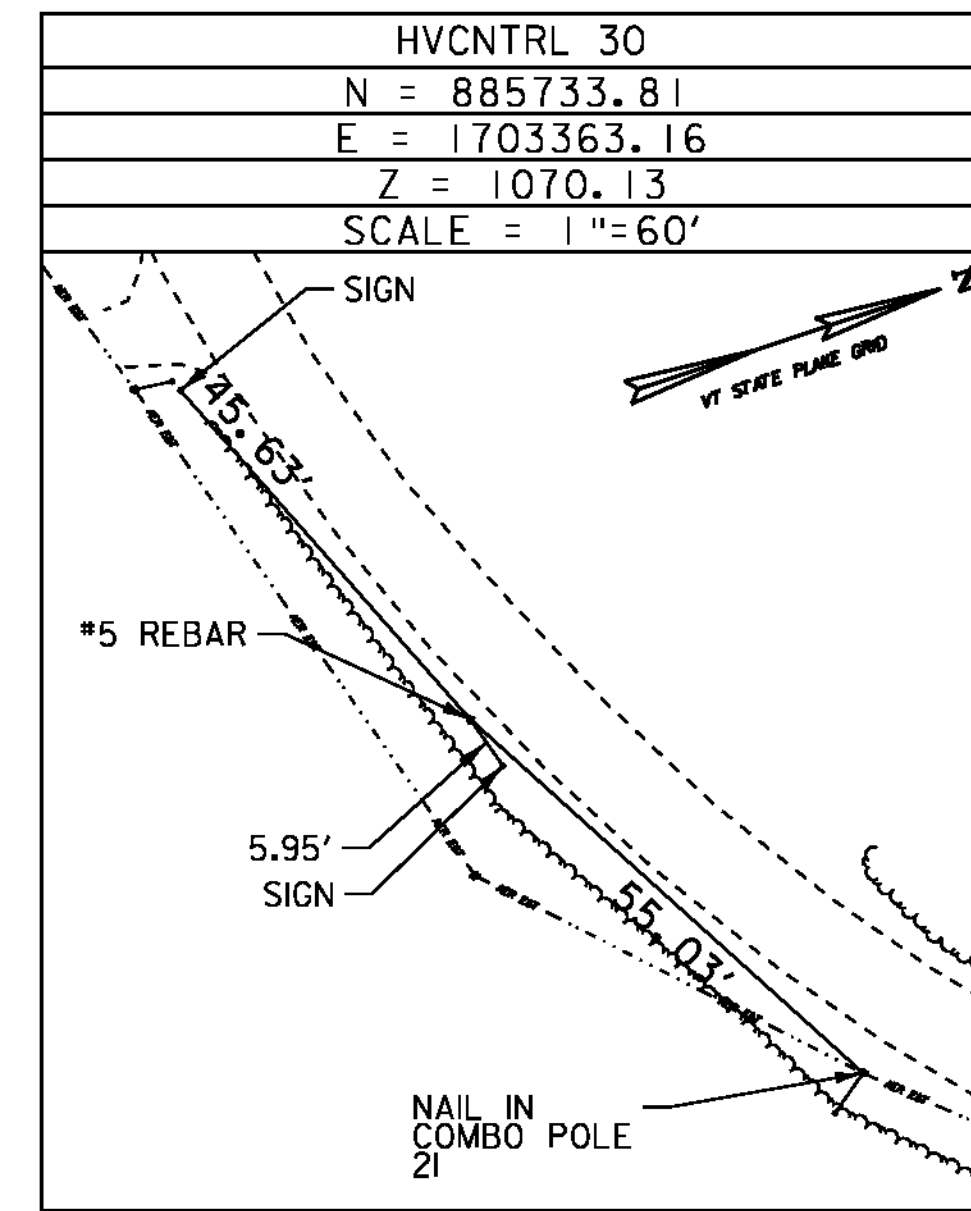
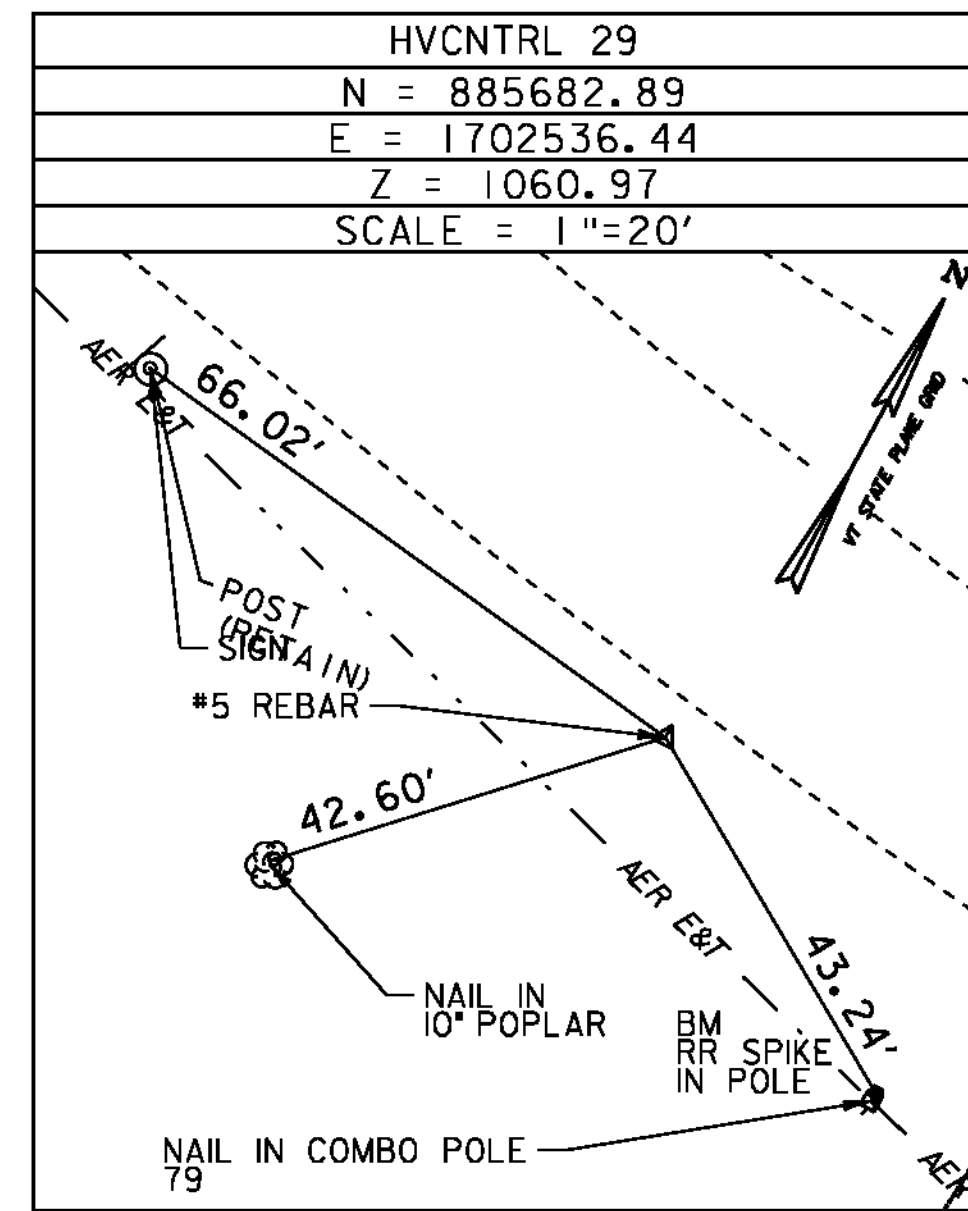
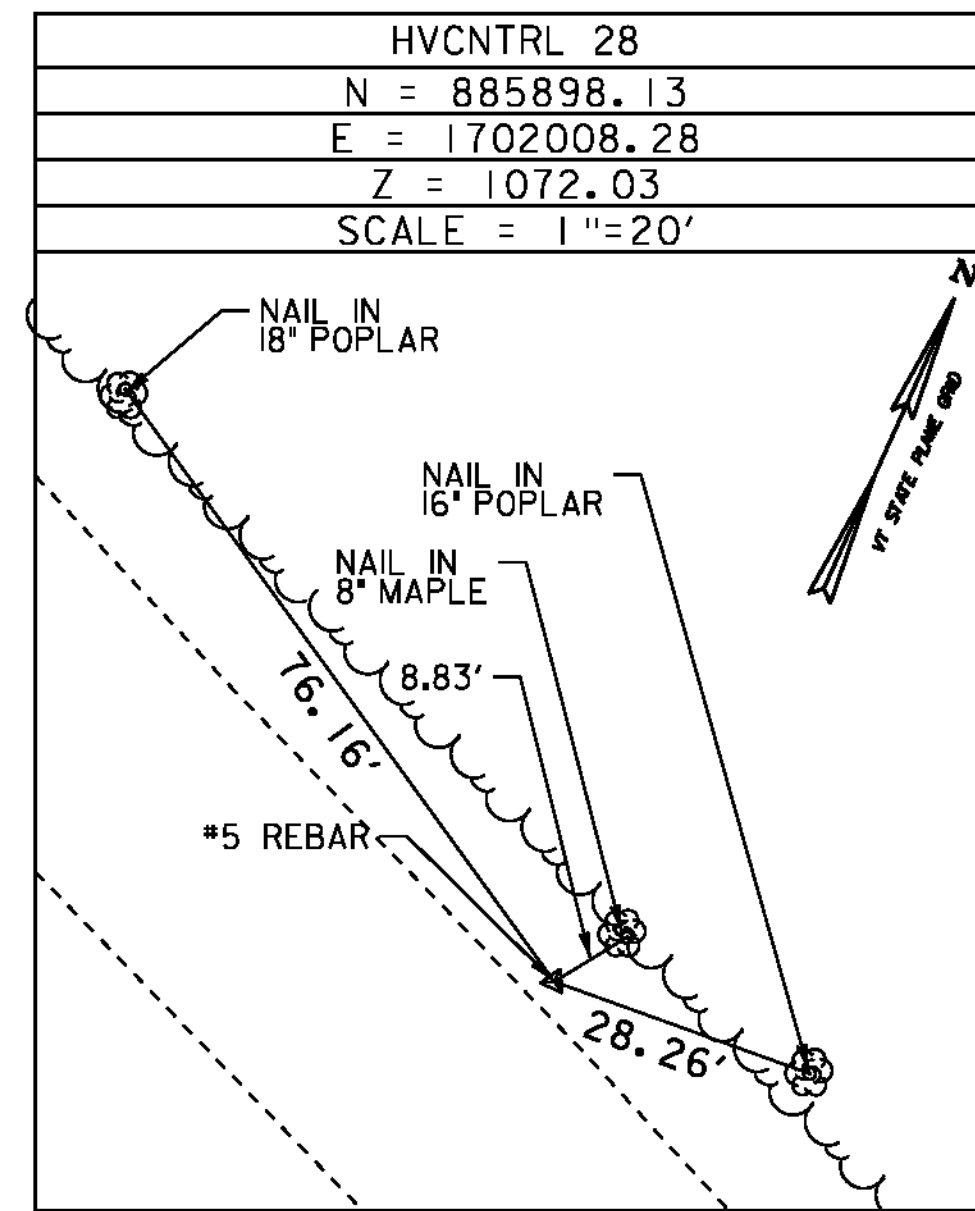
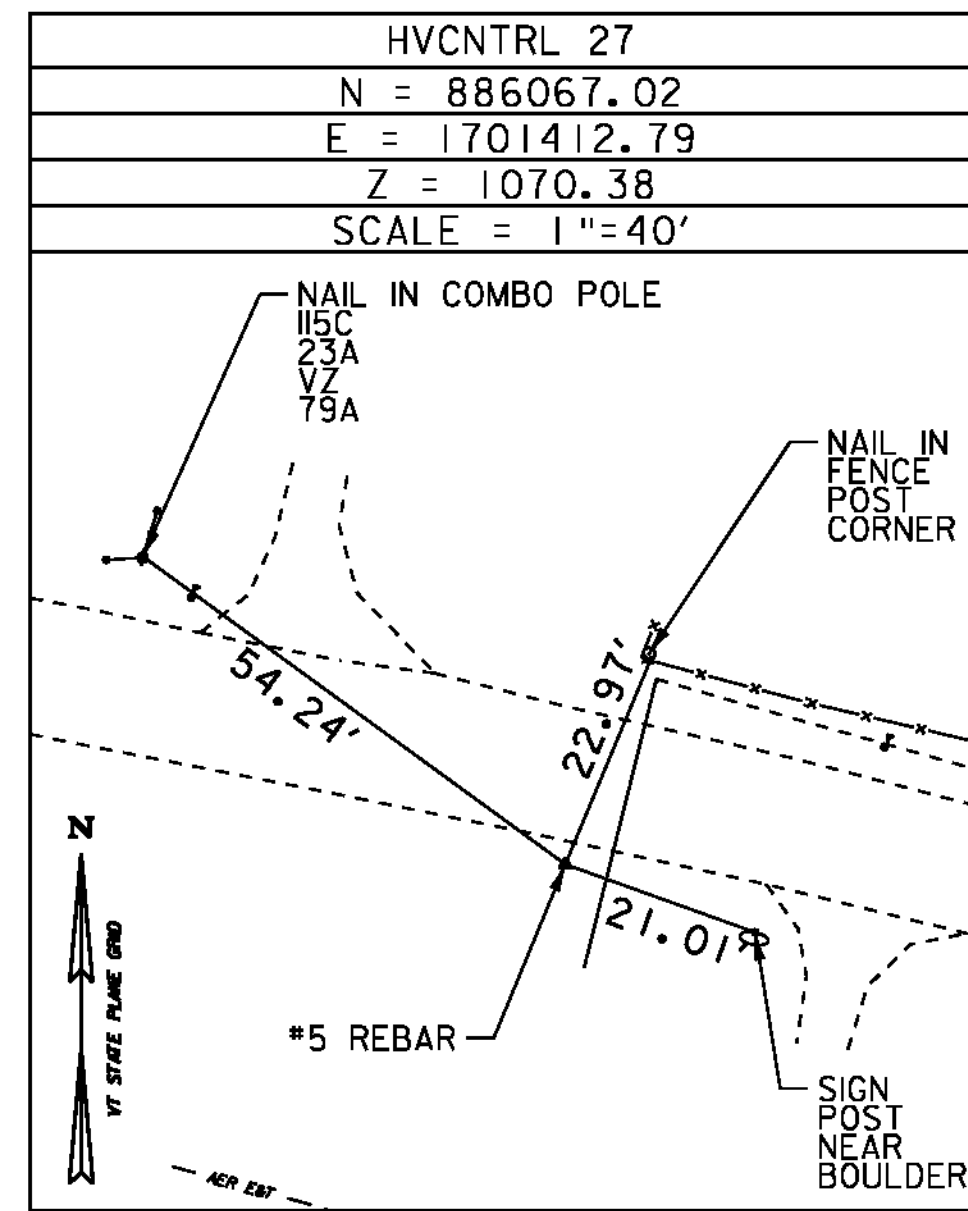

DATUM  
 VERTICAL NAVD 88  
 HORIZONTAL NAD 83  
 ADJUSTMENT \_\_\_\_\_

**TIE SHEET 3**

PROJECT NAME:	NEWPORT-COVENTRY-NEWPORT
PROJECT NUMBER:	STP 2802(I)
FILE NAME:	08b158.dgn
PROJECT LEADER:	CDL
DESIGNED BY:	BMB
PLOT FILE:	08b158-20.i
PLOT DATE:	8/3/2011
DRAWN BY:	BMB
CHECKED BY:	EPD
SHEET	20 OF 134