

COLOR: BLACK BORDER & LEGEND
YELLOW BACKGROUND (RETROREFLECTIVE)

MATERIAL: PER VAOT STANDARD E-151

LOCATION: VT. ROUTE 114
WARREN GORE:
STA 154+17.6, RT

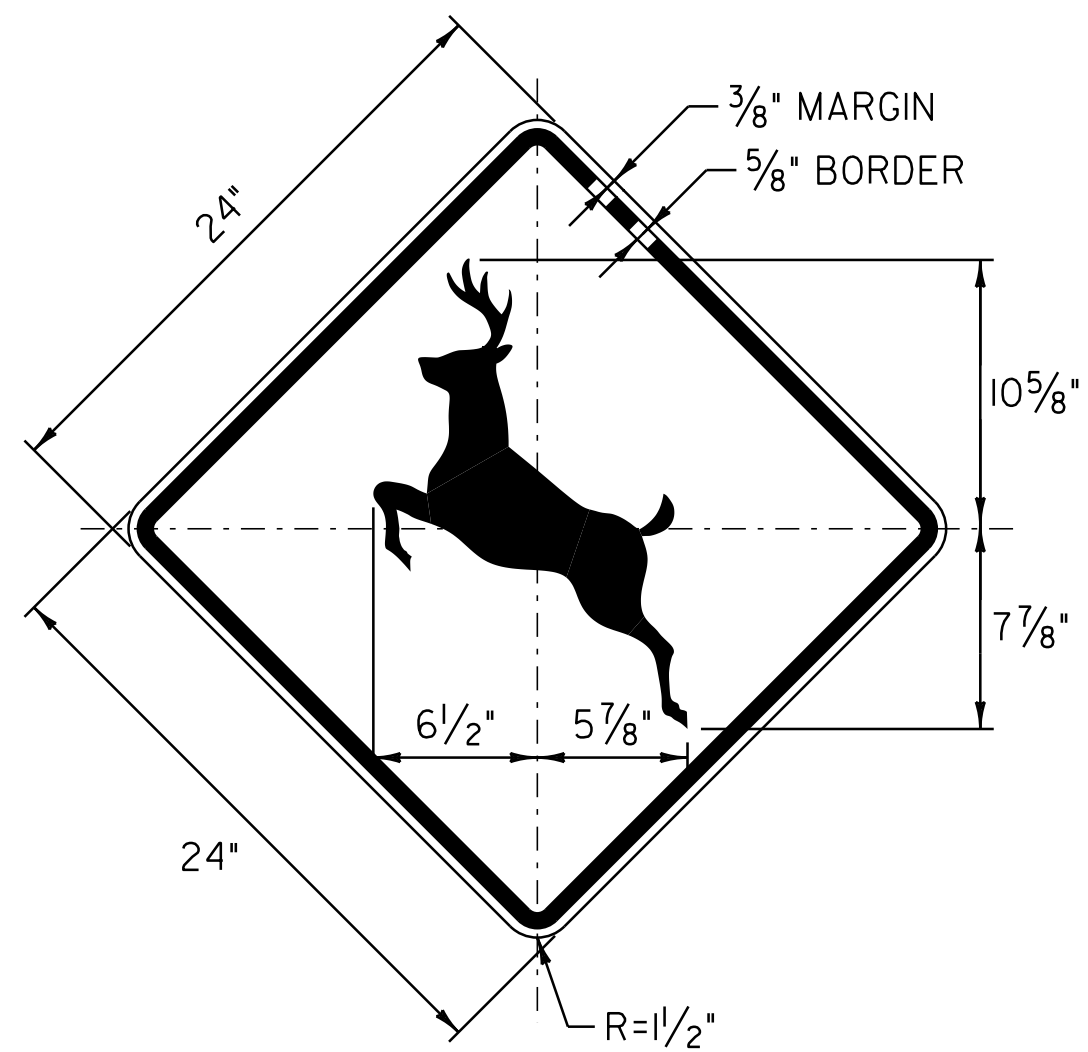

COLOR: BLACK BORDER & LEGEND
YELLOW BACKGROUND (RETROREFLECTIVE)

MATERIAL: PER VAOT STANDARD E-153

LOCATION: VT. ROUTE 114
NORTON:
STA 125+66.4, LT

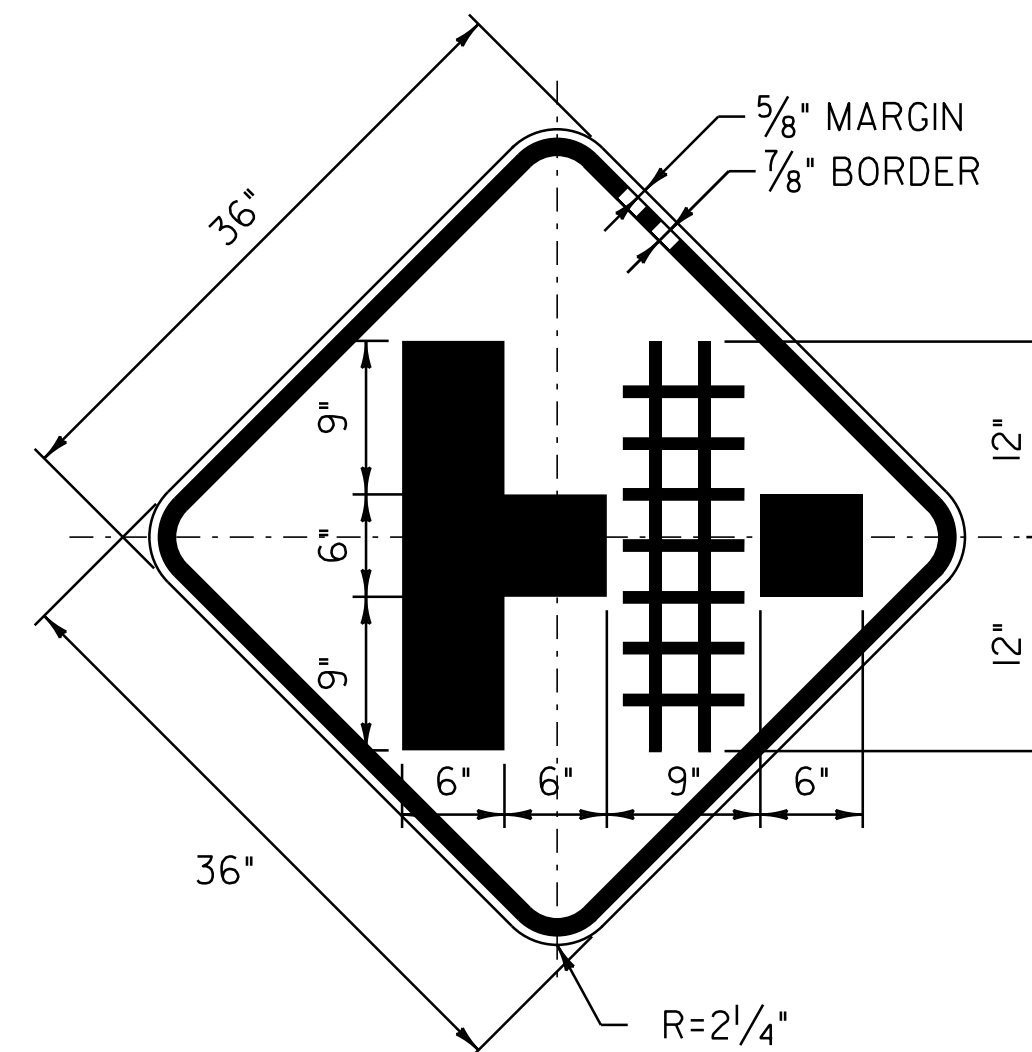

COLOR: BLACK BORDER & LEGEND
YELLOW BACKGROUND (RETROREFLECTIVE)

MATERIAL: PER VAOT STANDARD E-151

LOCATION: VT. ROUTE 114
NORTON:
STA 175+29.6 LT

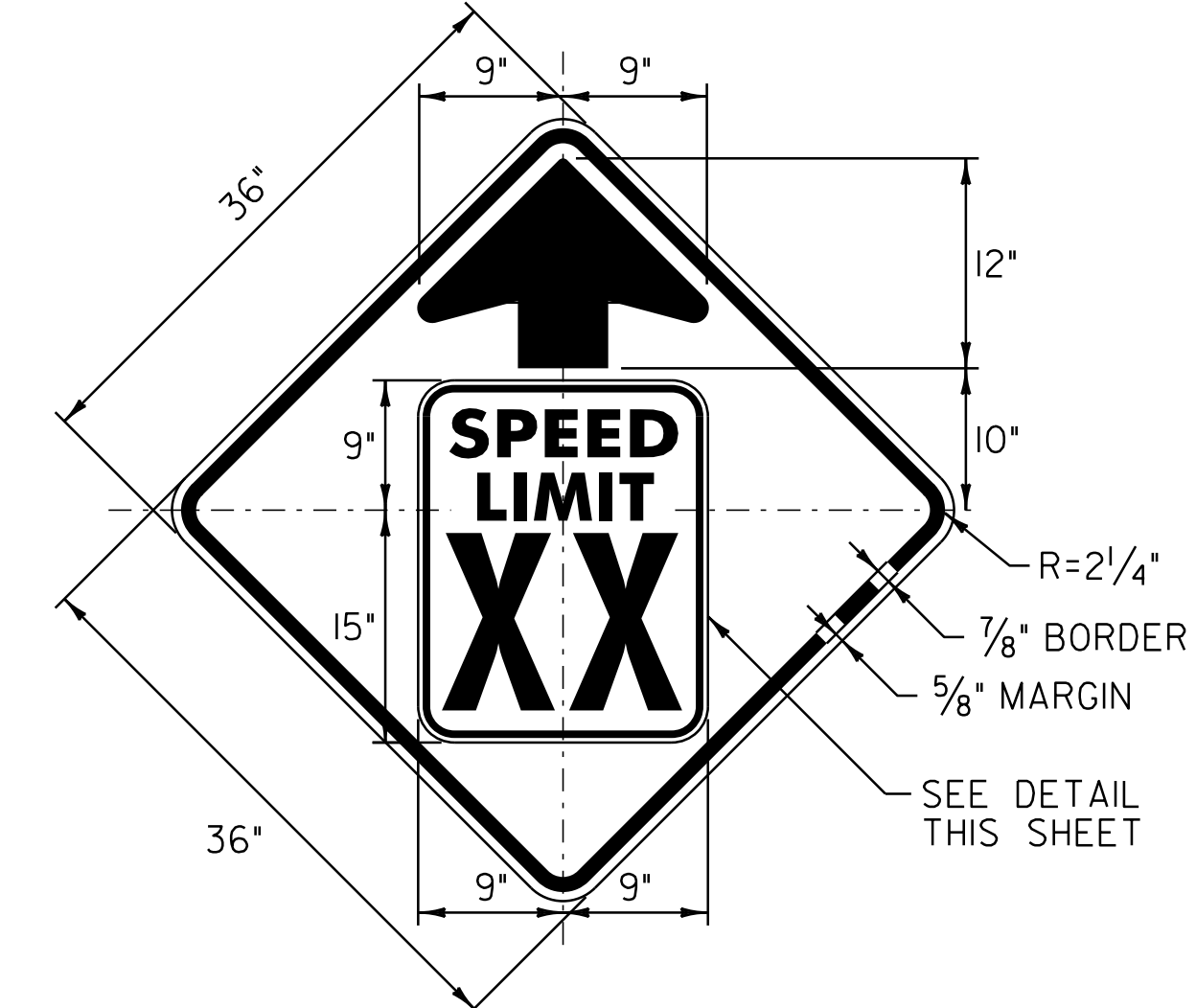

COLOR: BLACK BORDER & LEGEND
YELLOW BACKGROUND (RETROREFLECTIVE)

MATERIAL: PER VAOT STANDARD E-150

LOCATION: VT. ROUTE 114
NORTON:
STA 247+63.2, RT

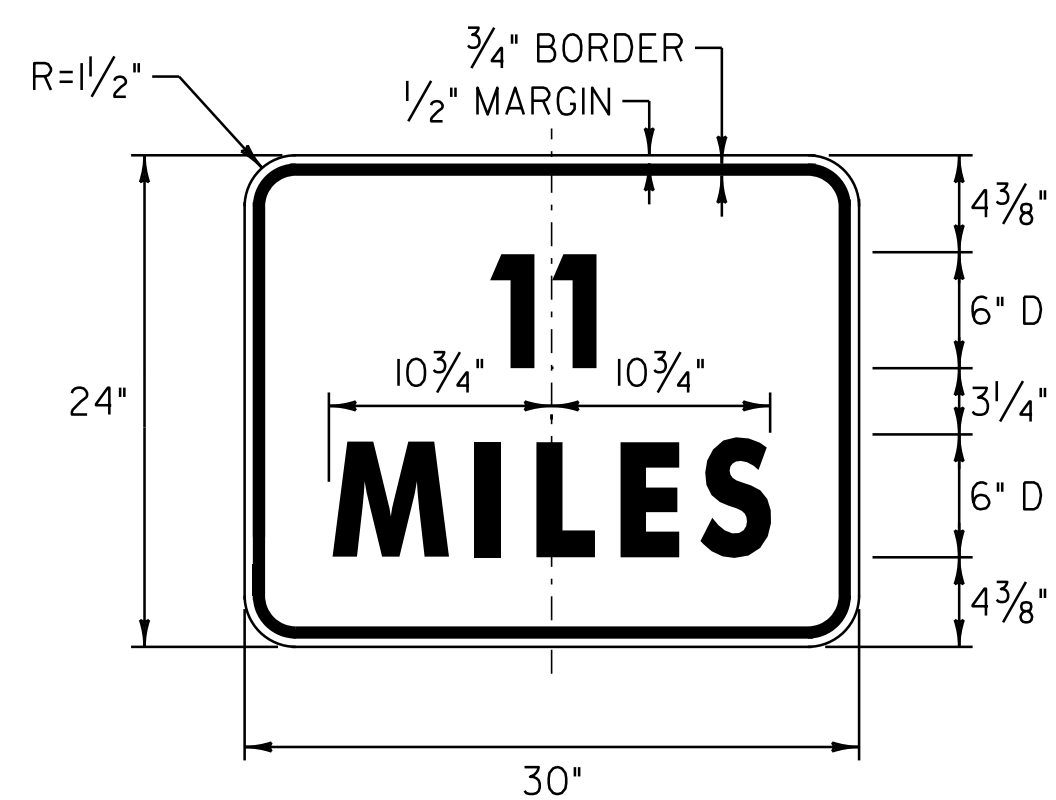

COLOR: BLACK BORDER & TEXT
YELLOW BACKGROUND (RETROREFLECTIVE)

MATERIAL: PER VAOT STANDARD E-153

LOCATION: VT. ROUTE 114
NORTON:
STA 264+00.0, LT

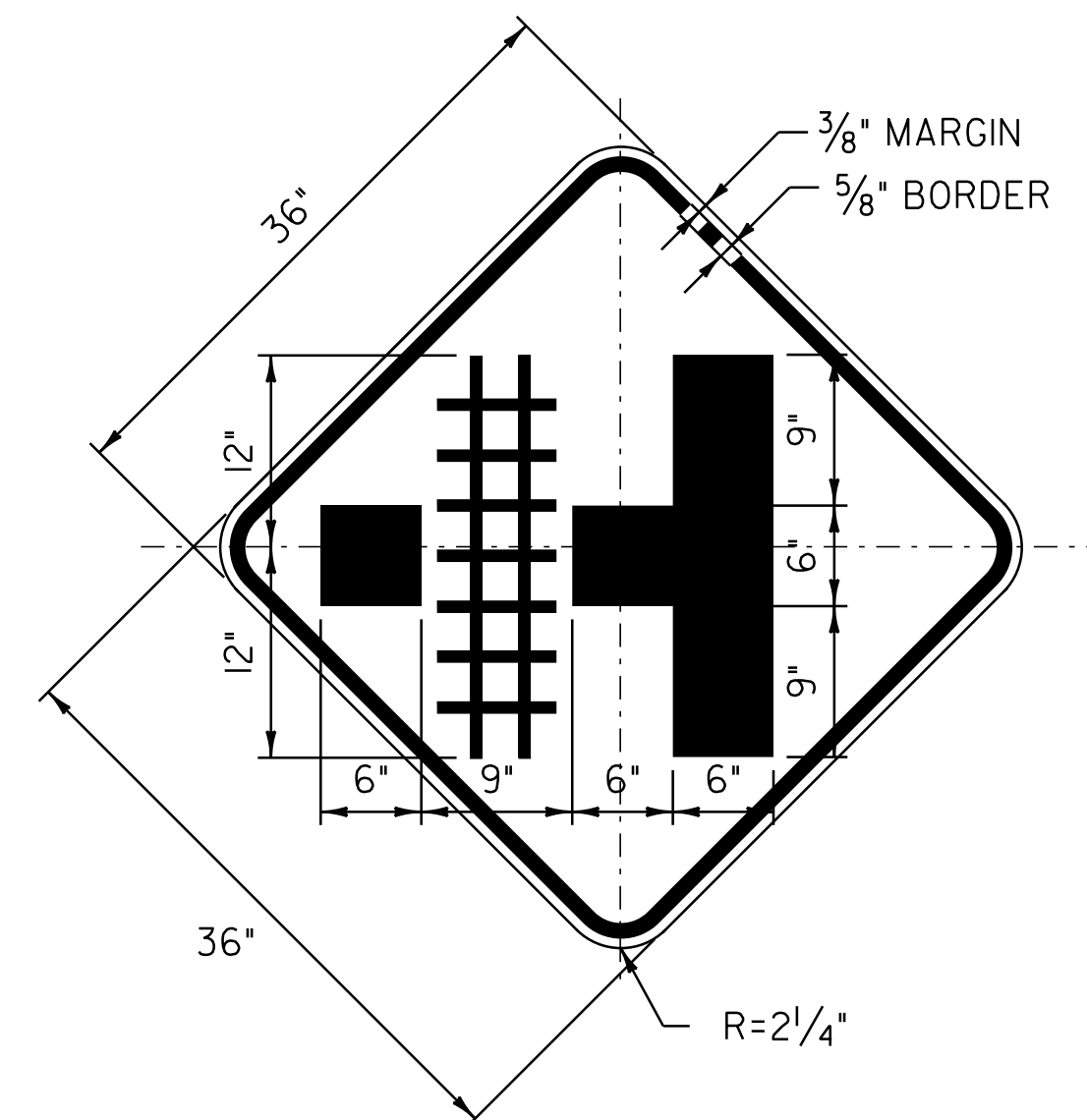
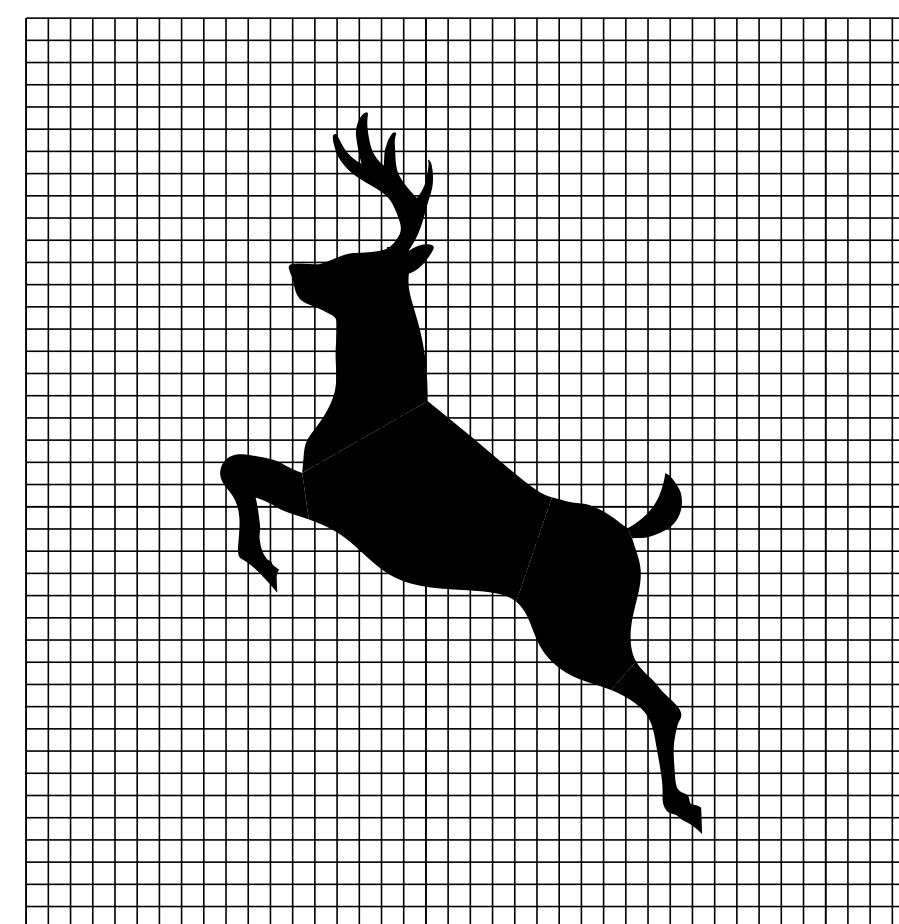

COLOR: BLACK BORDER & LEGEND
YELLOW BACKGROUND (RETROREFLECTIVE)

MATERIAL: PER VAOT STANDARD E-151

LOCATION: VT. ROUTE 114
NORTON:
STA 162+09.6 RT

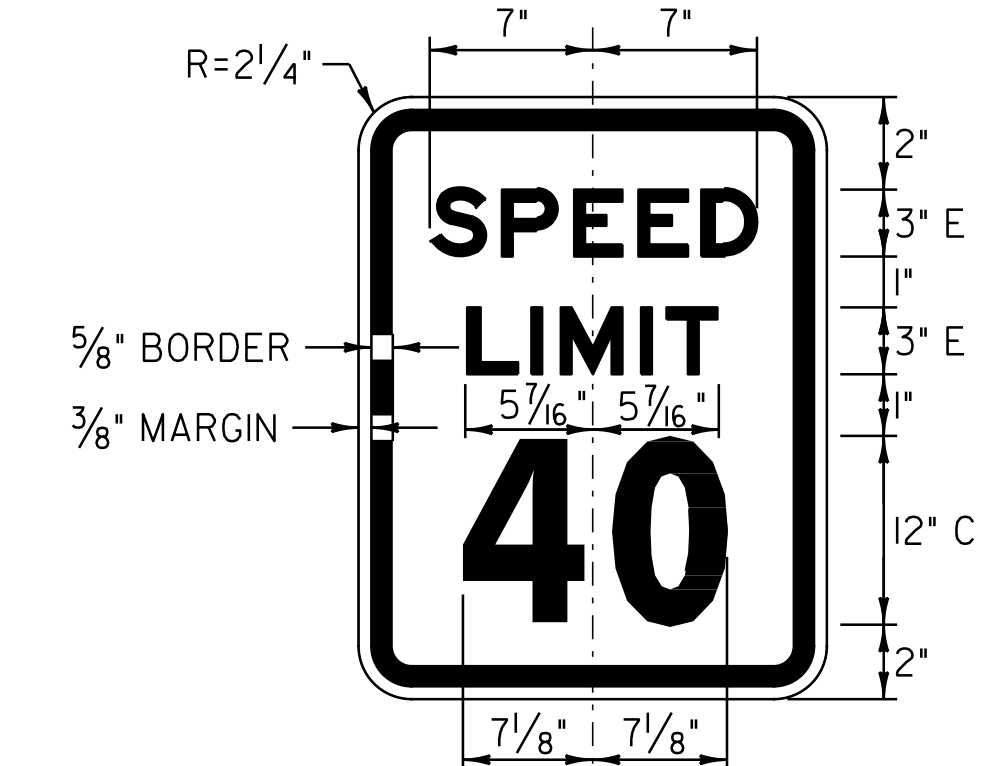

COLOR: BLACK BORDER & TEXT
WHITE BACKGROUND (RETROREFLECTIVE)

MATERIAL: PER VAOT STANDARD E-142

LOCATION: VT. ROUTE 114
NORTON:
STA 251+44, RT

NOT TO SCALE

**TRAFFIC
SIGN
DETAIL
SHEET**

PROJECT NAME: WARREN GORE - NORTON

PROJECT NUMBER: STP 2725(0)S

FILE NAME: p07c218.dgn
PROJECT LEADER: D.E.G.
DESIGNED BY: M.J.L.
IPARM FILE: p06c058+sd.i

PLOT DATE: 31-OCT-2011 11:54
DRAWN BY: C.A.K.
CHECKED BY: D.W.E.
SHEET 102 OF 107