

**VD1-1**

LOCATION: HIGHGATE STA. 170+65, LT  
 COLOR: WHITE BORDER, ARROW AND TEXT (RETROREFLECTIVE)  
 GREEN BACKGROUND (RETROREFLECTIVE)  
 MATERIAL: 0.125" FLAT SHEET ALUMINUM  
 \* FOR ARROW DETAIL SEE SHEET I19

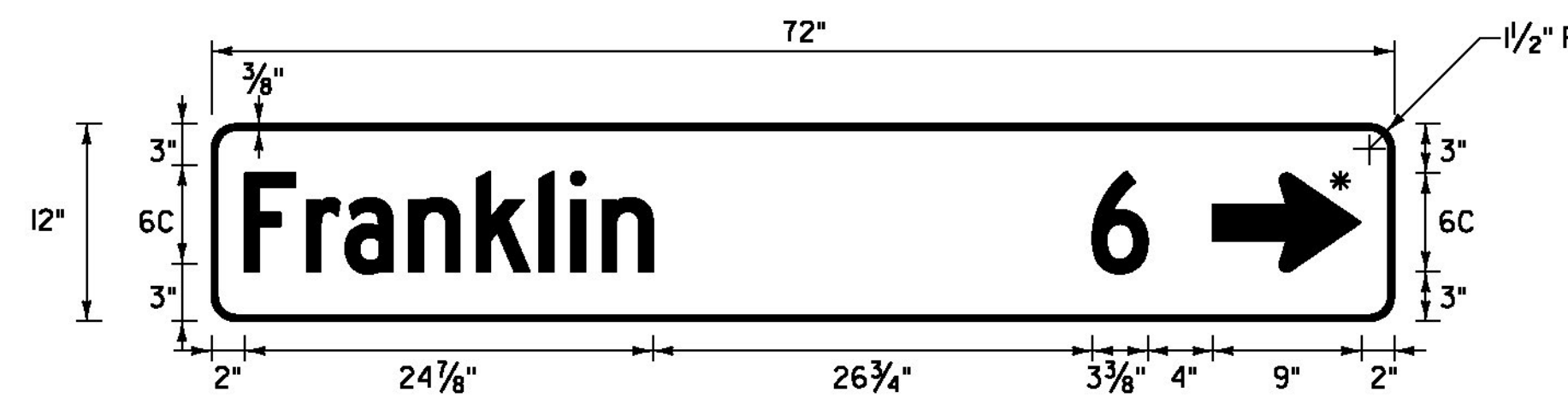

**VD1-1a**

LOCATION: HIGHGATE STA. 248+34, LT  
 COLOR: WHITE BORDER, ARROW AND TEXT (RETROREFLECTIVE)  
 GREEN BACKGROUND (RETROREFLECTIVE)  
 MATERIAL: 0.125" FLAT SHEET ALUMINUM  
 \* FOR ARROW DETAIL SEE SHEET I19

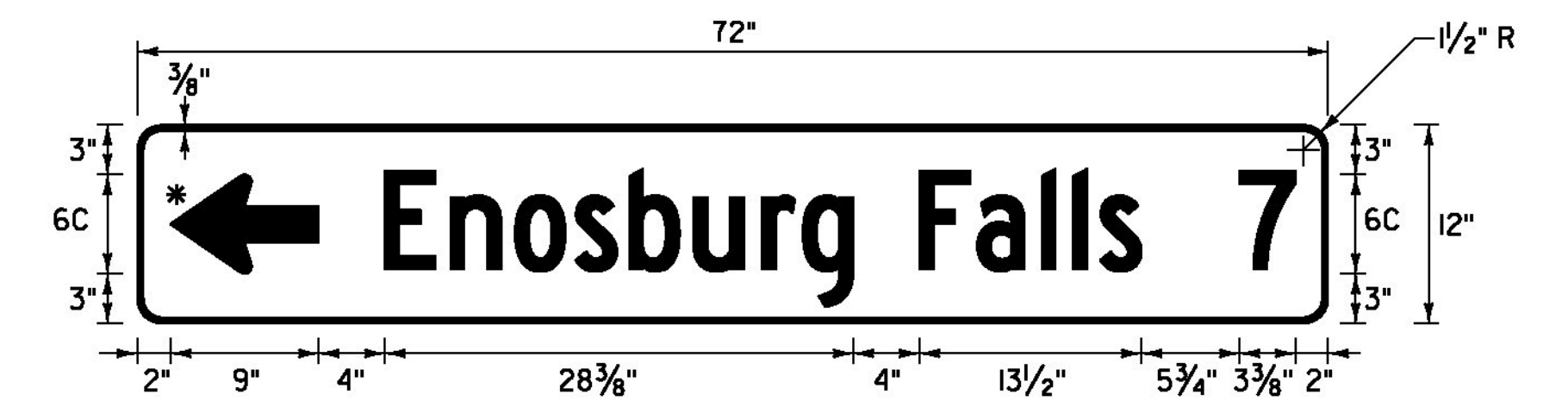

**VD1-1a**

LOCATION: SHELDON STA. 91+43, RT  
 COLOR: WHITE BORDER, ARROW AND TEXT (RETROREFLECTIVE)  
 GREEN BACKGROUND (RETROREFLECTIVE)  
 MATERIAL: 0.125" FLAT SHEET ALUMINUM  
 \* FOR ARROW DETAIL SEE SHEET I19

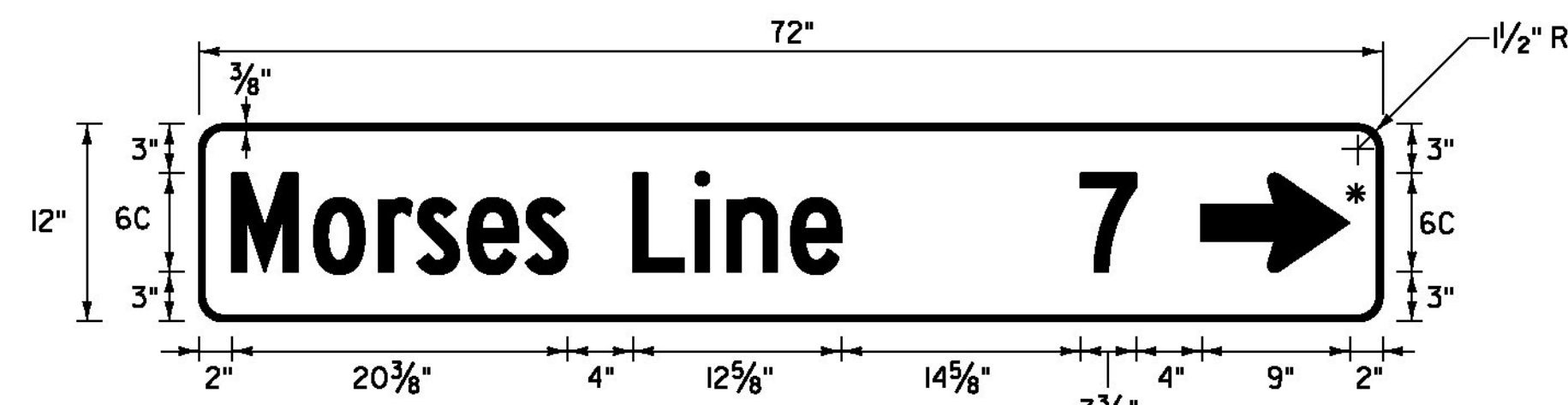

**VD1-1a**

LOCATION: HIGHGATE STA. 170+65, LT  
 COLOR: WHITE BORDER, ARROW AND TEXT (RETROREFLECTIVE)  
 GREEN BACKGROUND (RETROREFLECTIVE)  
 MATERIAL: 0.125" FLAT SHEET ALUMINUM  
 \* FOR ARROW DETAIL SEE SHEET I19

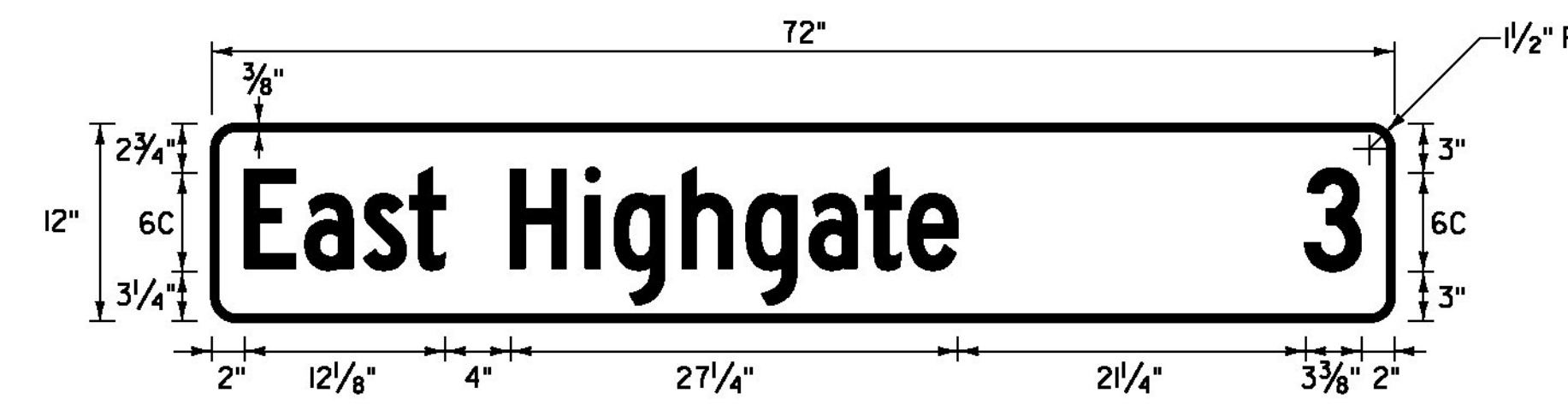

**VD2-1**

LOCATION: SHELDON STA. 91+26, LT  
 COLOR: WHITE BORDER, ARROW AND TEXT (RETROREFLECTIVE)  
 GREEN BACKGROUND (RETROREFLECTIVE)  
 MATERIAL: 0.125" FLAT SHEET ALUMINUM

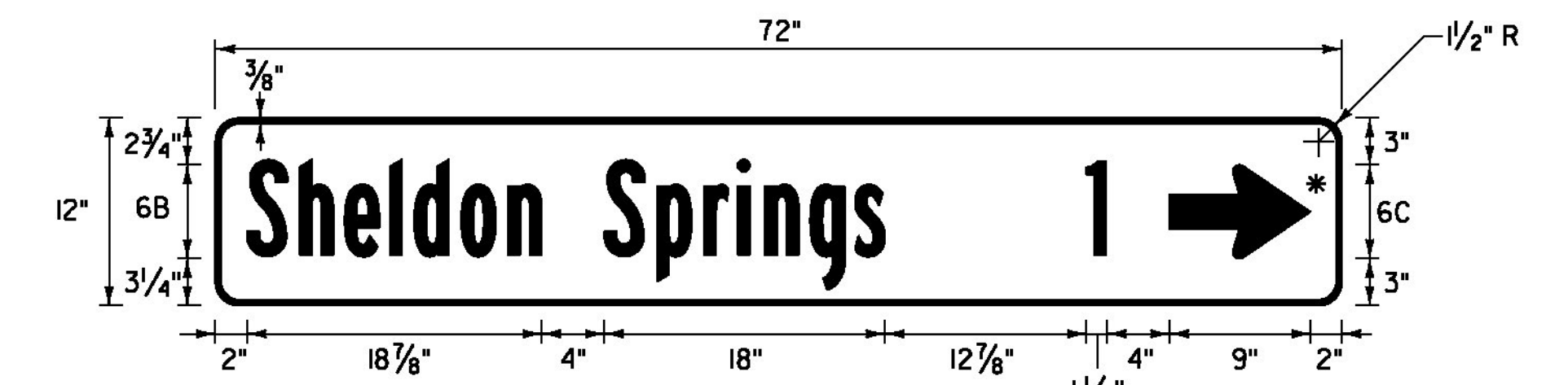

**VD1-1a**

LOCATION: SHELDON STA. 91+43, RT  
 COLOR: WHITE BORDER, ARROW AND TEXT (RETROREFLECTIVE)  
 GREEN BACKGROUND (RETROREFLECTIVE)  
 MATERIAL: 0.125" FLAT SHEET ALUMINUM  
 \* FOR ARROW DETAIL SEE SHEET I19

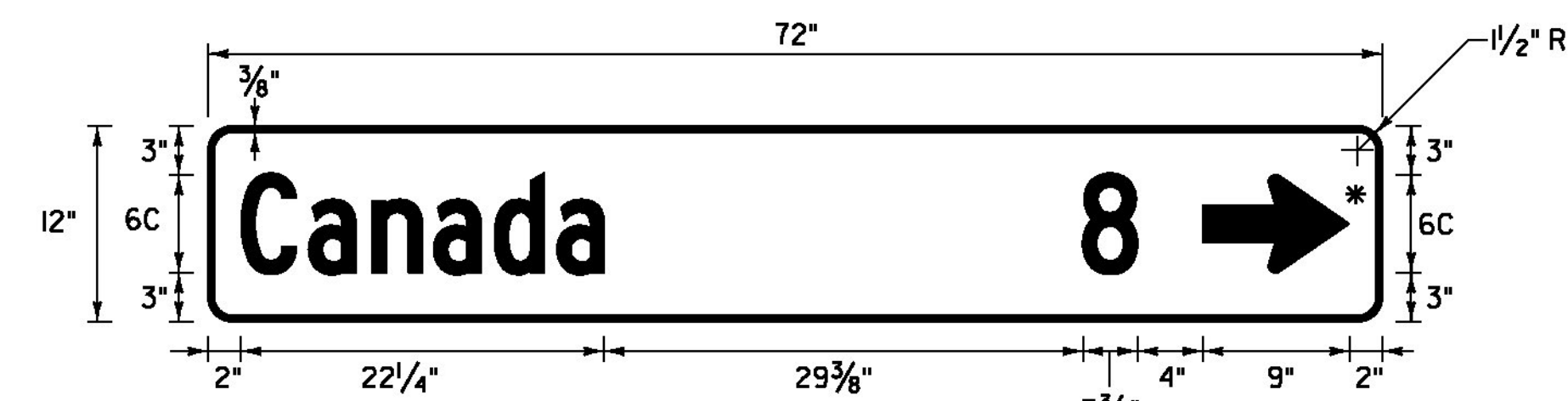

**VD1-1a**

LOCATION: HIGHGATE STA. 170+65, LT  
 COLOR: WHITE BORDER, ARROW AND TEXT (RETROREFLECTIVE)  
 GREEN BACKGROUND (RETROREFLECTIVE)  
 MATERIAL: 0.125" FLAT SHEET ALUMINUM  
 \* FOR ARROW DETAIL SEE SHEET I19

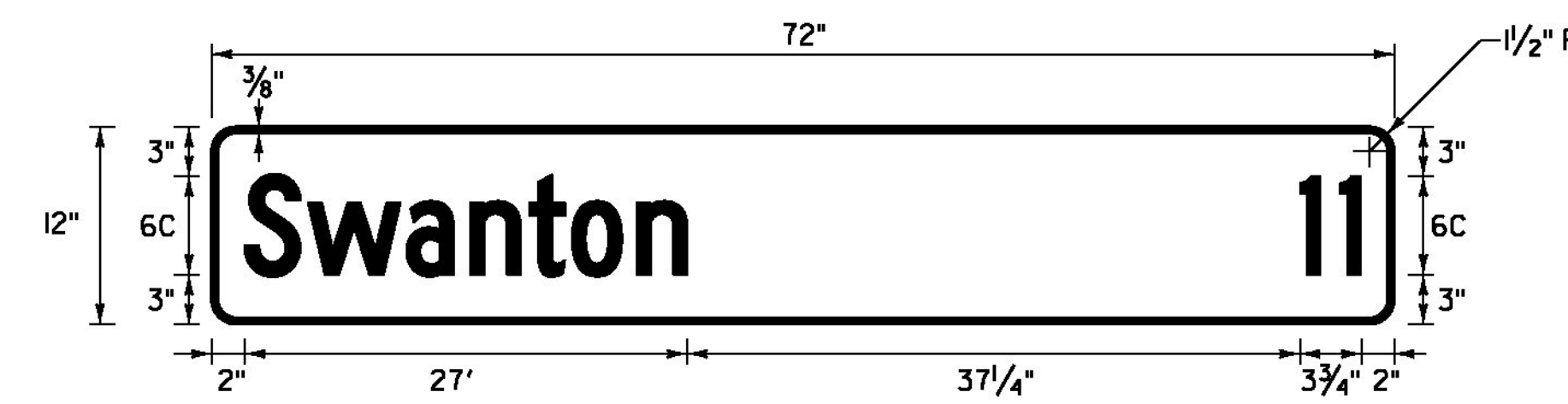

**VD2-1**

LOCATION: SHELDON STA. 91+26, LT  
 COLOR: WHITE BORDER, ARROW AND TEXT (RETROREFLECTIVE)  
 GREEN BACKGROUND (RETROREFLECTIVE)  
 MATERIAL: 0.125" FLAT SHEET ALUMINUM

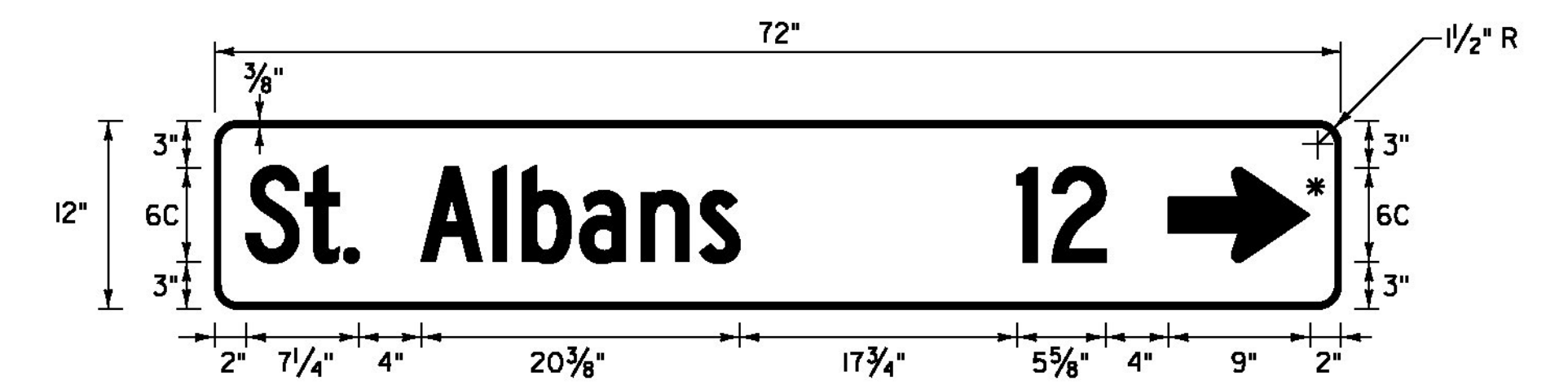

**VD1-1a**

LOCATION: SHELDON STA. 91+43, RT  
 COLOR: WHITE BORDER, ARROW AND TEXT (RETROREFLECTIVE)  
 GREEN BACKGROUND (RETROREFLECTIVE)  
 MATERIAL: 0.125" FLAT SHEET ALUMINUM  
 \* FOR ARROW DETAIL SEE SHEET I19

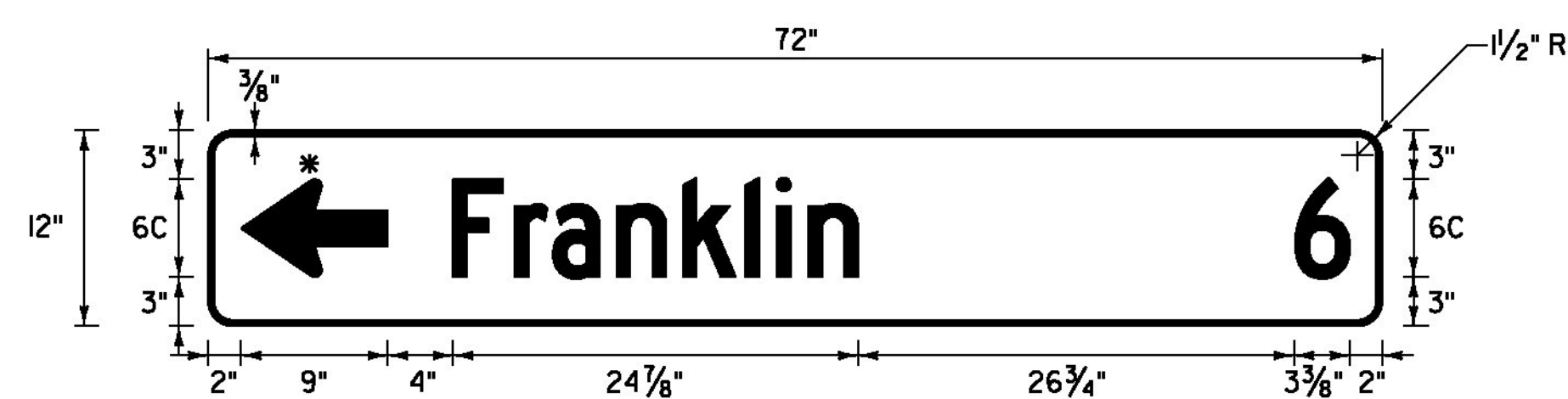

**VD1-1a**

LOCATION: HIGHGATE STA. 242+42, RT  
 COLOR: WHITE BORDER, ARROW AND TEXT (RETROREFLECTIVE)  
 GREEN BACKGROUND (RETROREFLECTIVE)  
 MATERIAL: 0.125" FLAT SHEET ALUMINUM  
 \* FOR ARROW DETAIL SEE SHEET I19

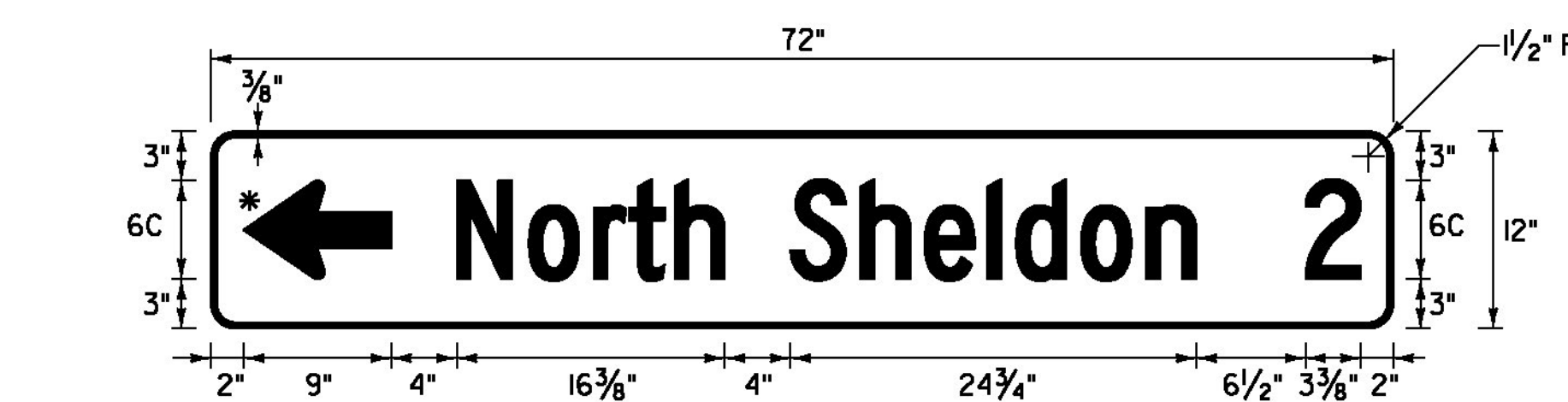

**VD1-1a**

LOCATION: SHELDON STA. 91+43, RT  
 COLOR: WHITE BORDER, ARROW AND TEXT (RETROREFLECTIVE)  
 GREEN BACKGROUND (RETROREFLECTIVE)  
 MATERIAL: 0.125" FLAT SHEET ALUMINUM  
 \* FOR ARROW DETAIL SEE SHEET I19

NOT TO SCALE

NOTE: SEE TRAFFIC SIGN NOTES ON SHEET I19.

**TRAFFIC SIGN  
 DETAIL  
 SHEET #5**

PROJECT NAME: SWANTON-SHELDON	PLOT DATE: 4/25/2014
PROJECT NUMBER: STP 2715(I)	DRAWN BY: G. BARRETT
FILE NAME: p07cl86.dgn	CHECKED BY: M. FOISY
PROJECT LEADER: G. EDWARDS	SHEET 116 OF 121
DESIGNED BY: G. BARRETT	

