

HVCTRL #1

Franklin Az MK
 Northing 908334.77
 Easting 1551937.16
 Elev: 436.94

To reach from the Intersection of VT route 120 (Lake Road) and VT route 236 (State Park Road), go southwest along route 120 for 0.4 mi to the site of the mark on the left, just south of a field drive. The mark is set 2 3/4 inches below ground surface in the top of a Feno style monument. It is 23.3 ft south of and about 6 in lower than the centerline of route 120, 372.5 ft east southeast of and across the road from an unnumbered pole, 19.7 ft east of the centerline of the field drive, 239.5 ft west of the center of the south (inlet) and of a 12 in diameter metal culvert, and 1 ft north of a fiberglass witness post.

HVCTRL #2

Franklin
 Northing 909262.34
 Easting 1554149.96
 Elev: 473.52

To reach from the Intersection of VT route 120 (Lake Road) and VT route 236 (State Park Road), go southwest along route 120 for 164 ft to the site of the mark on the right. The mark is set in the top of the south end of a 24.5 ft x 1.5 ft rock outcrop which projects 1 ft above ground surface. It is 54 ft north of and about .5 ft higher than the centerline of route 120, 155.5 ft northwest of the centerline of route 236, 89.3 ft west southwest of the south corner of a barn, 70.9 ft southwest of the west corner of the barn, 287 ft east of a wire fence and 181.5 ft west of pole #38F/18/11/E with meter and lumen.

* Description provided by Vermont Agency of Transportation Geodetic Survey Unit

TRAVERSE TIES

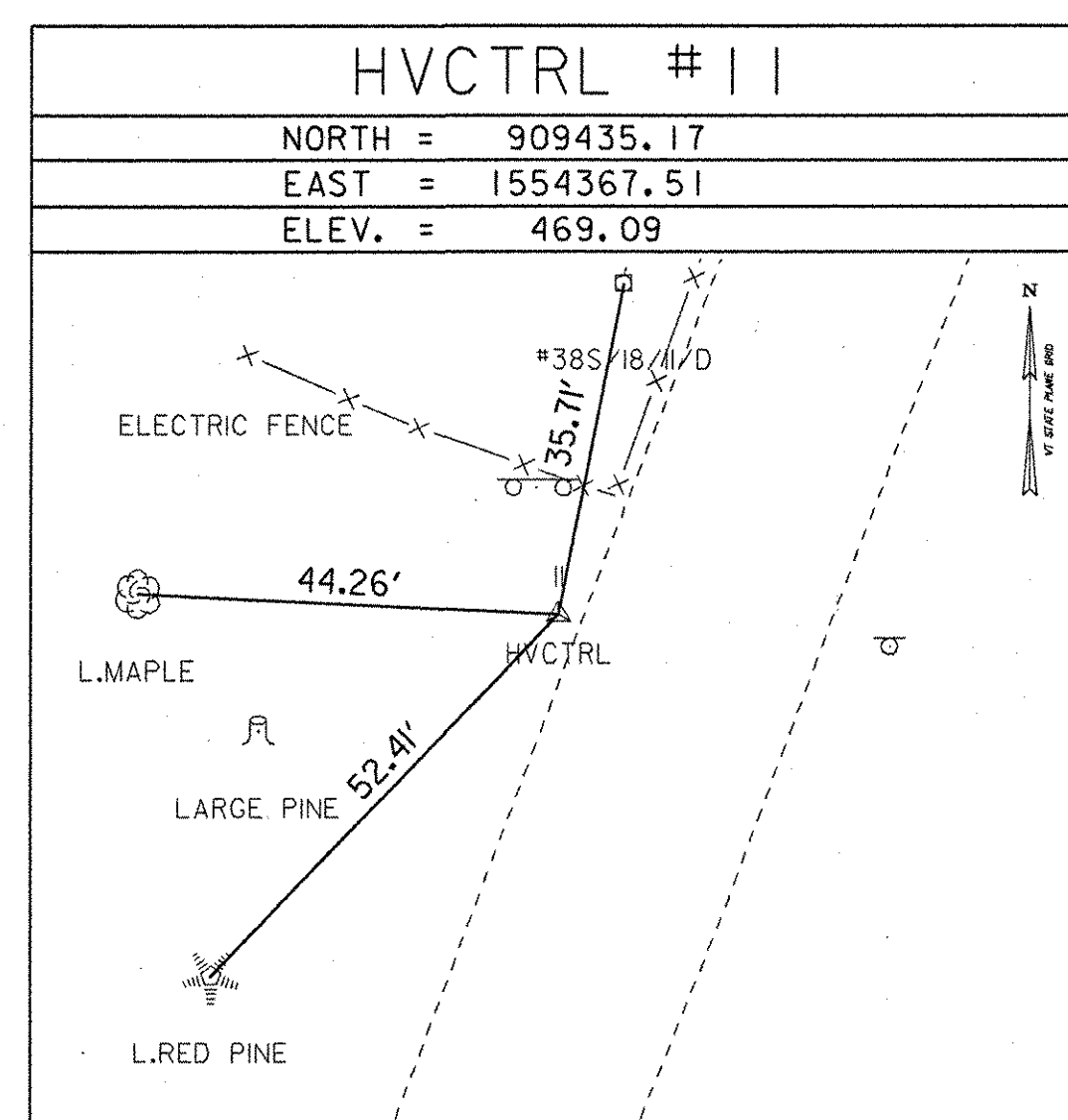
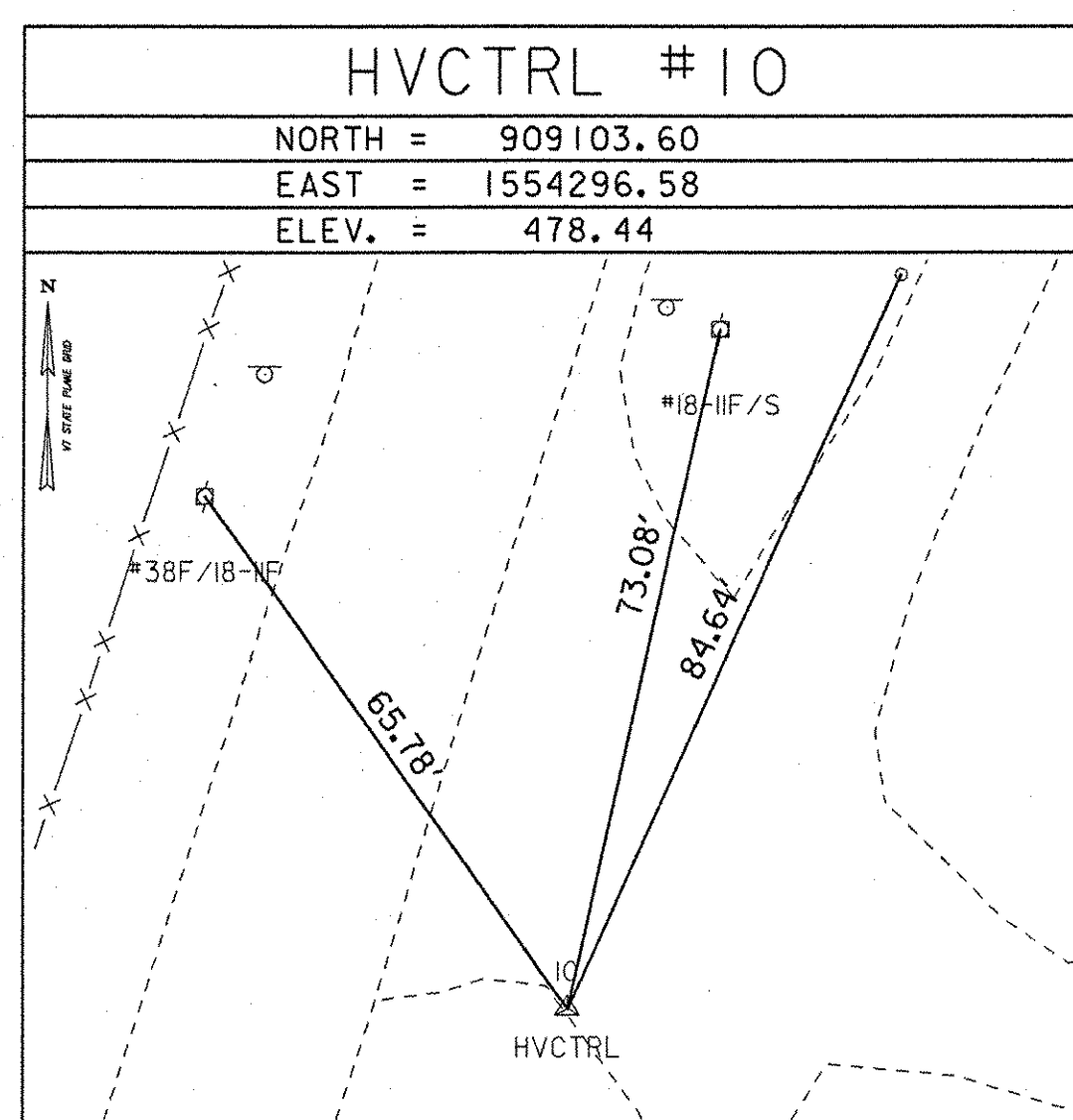

ALIGNMENT TIES

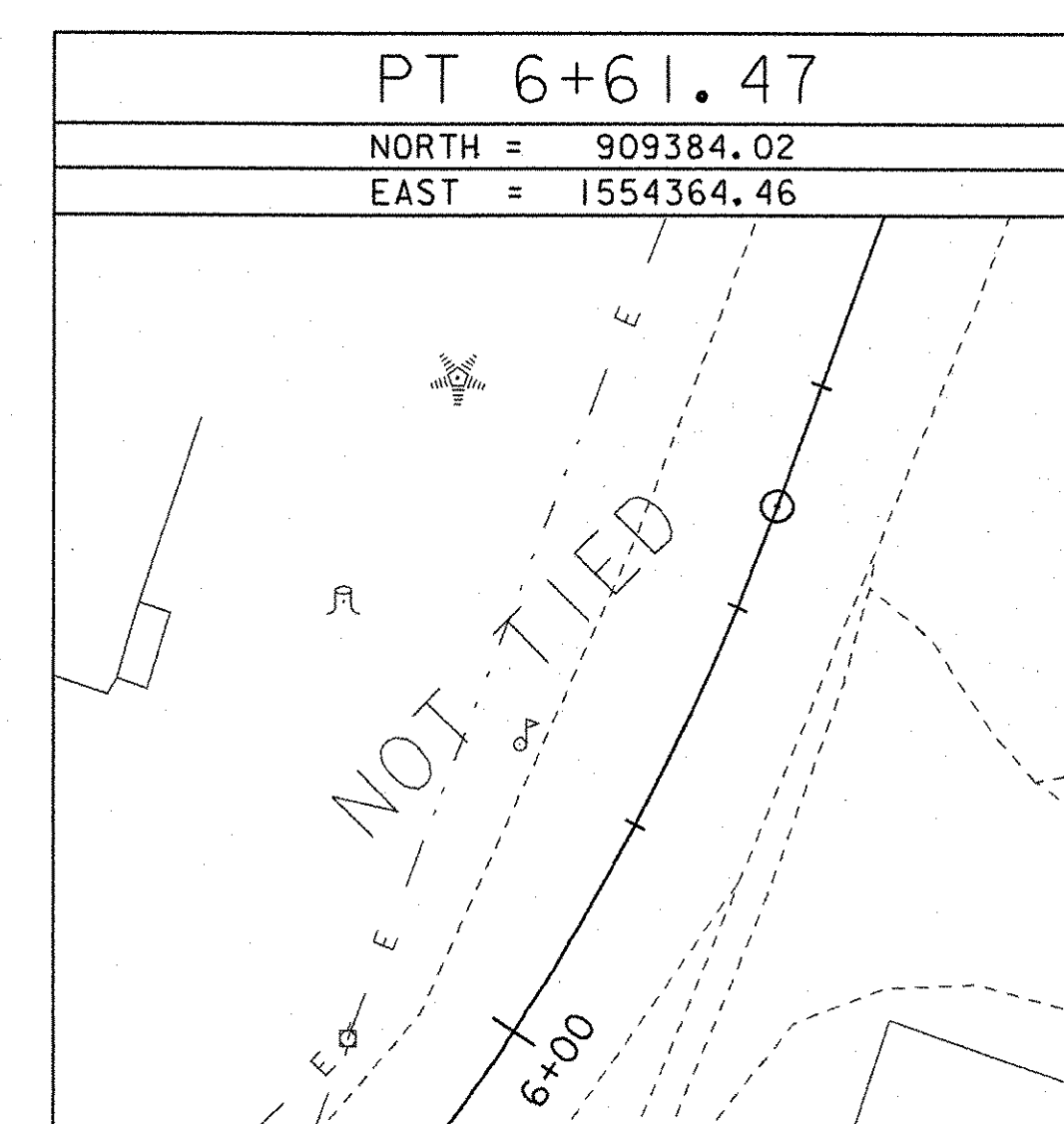
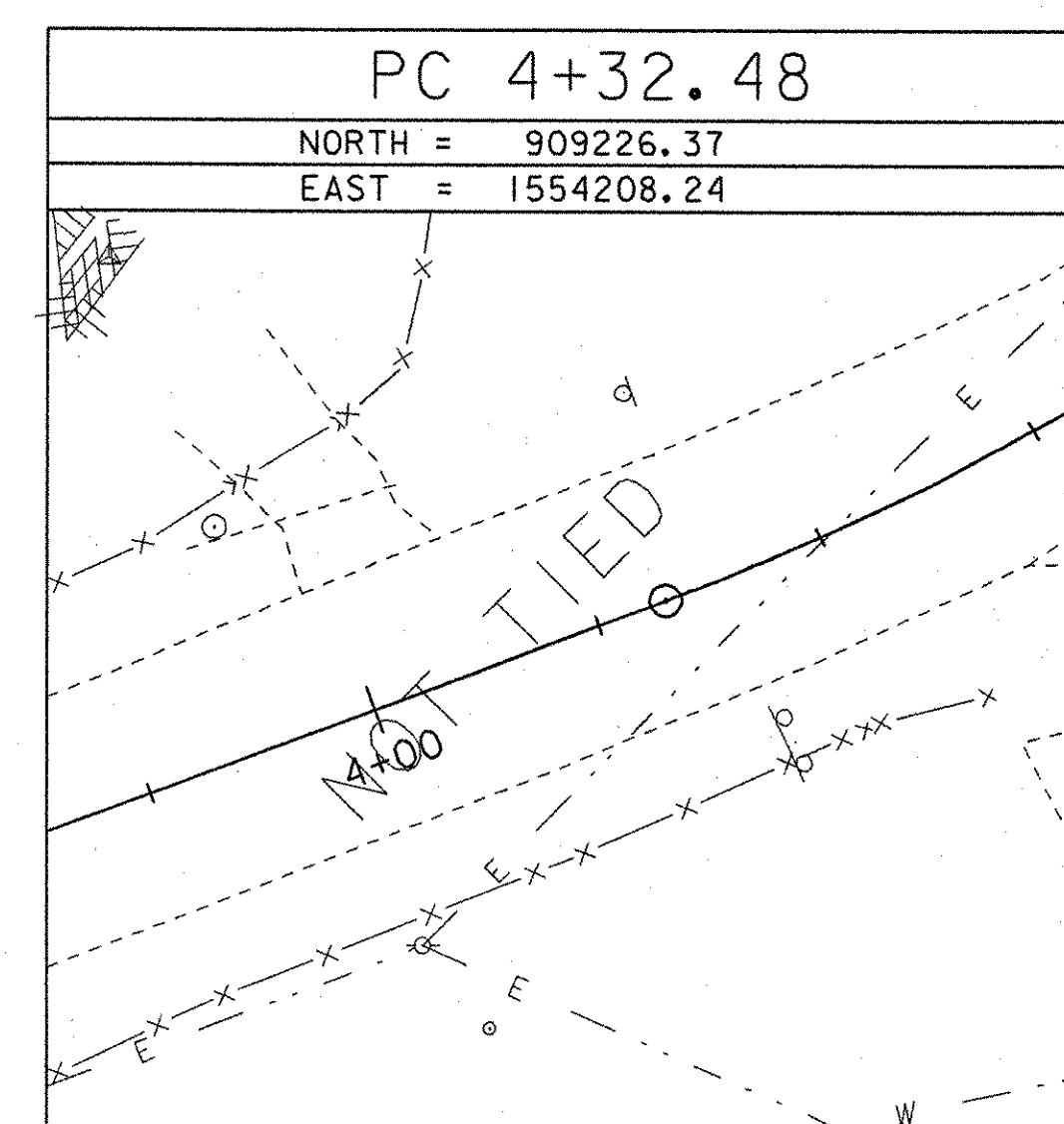
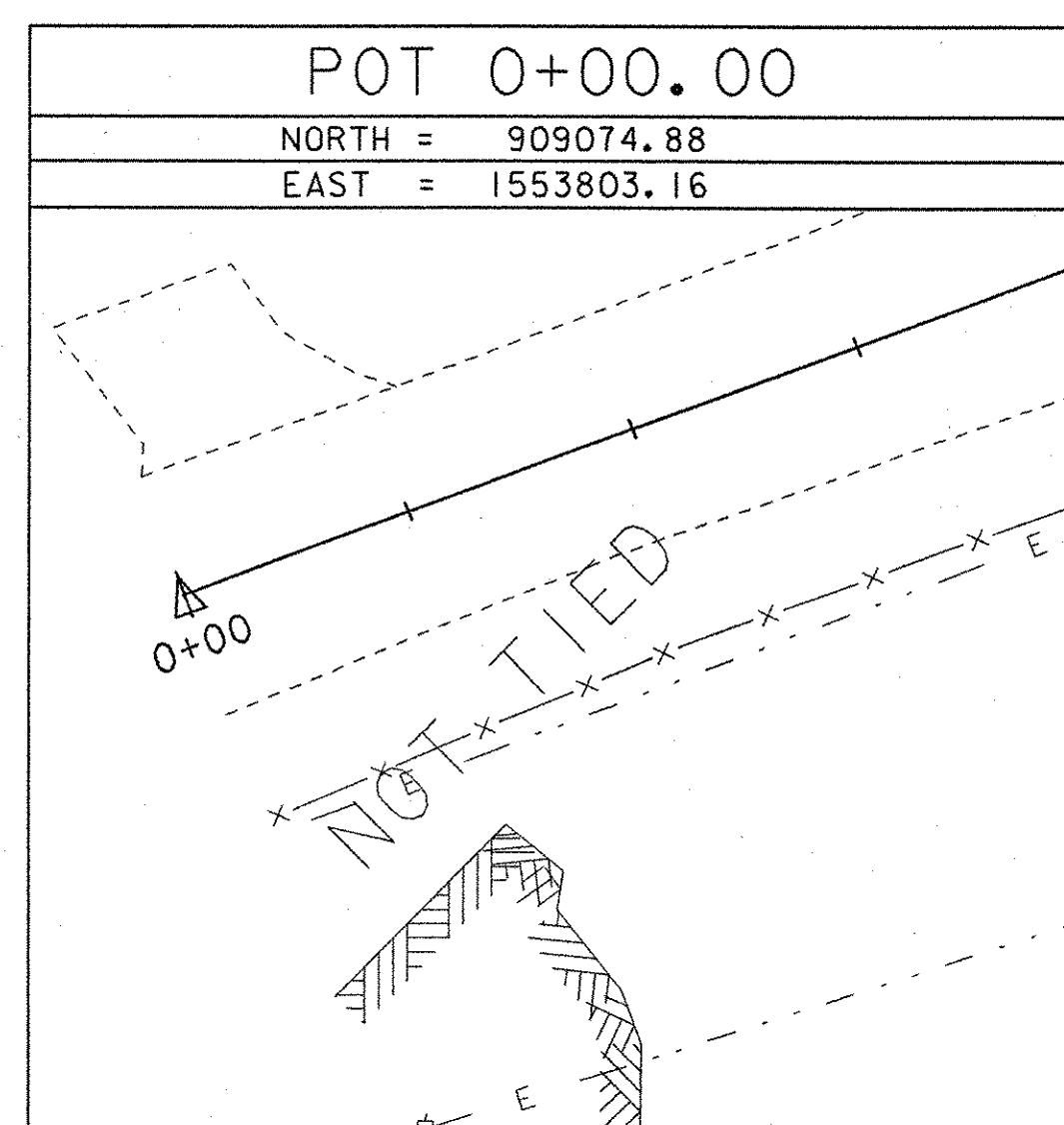

ALIGNMENT TIES

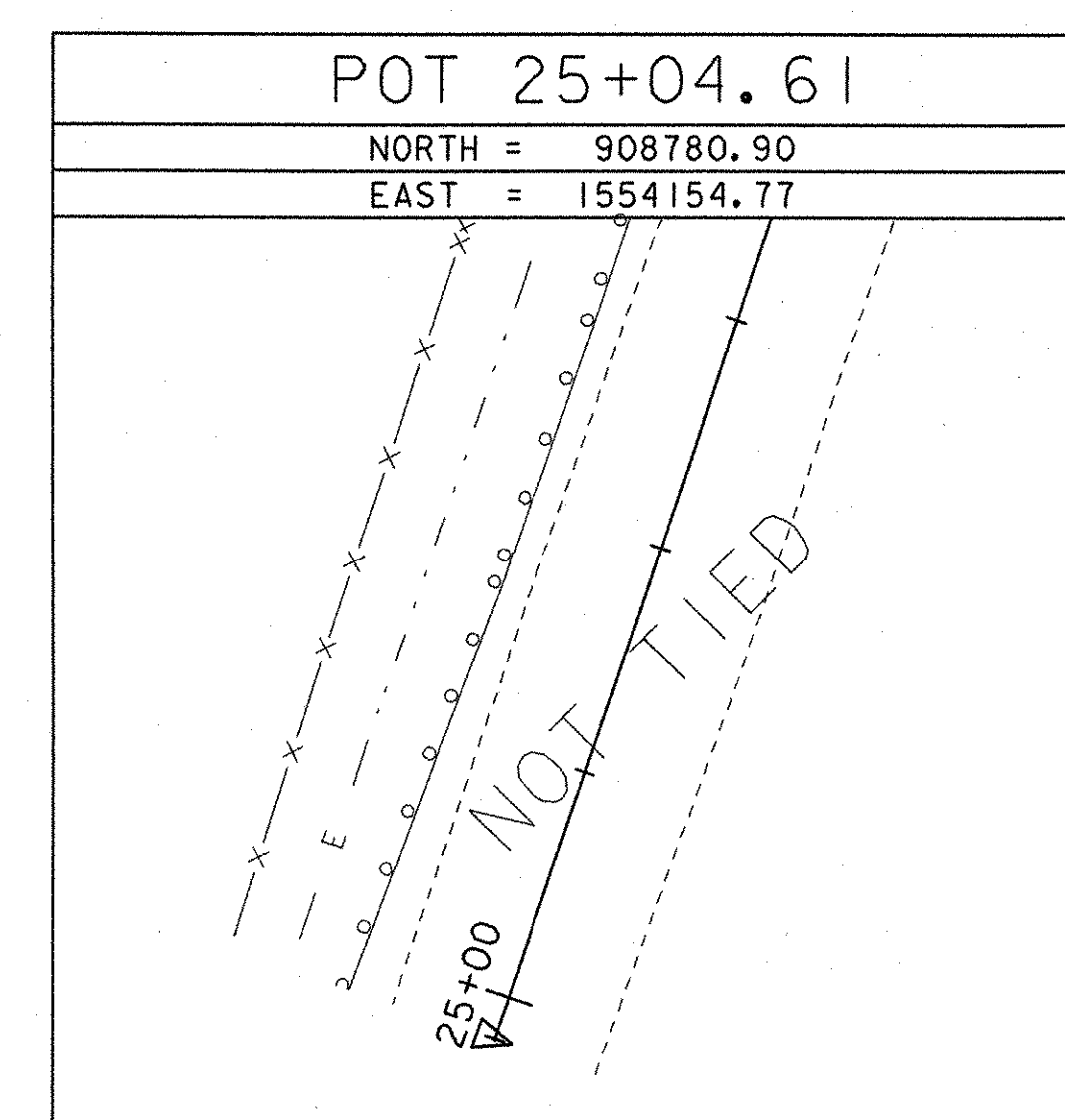
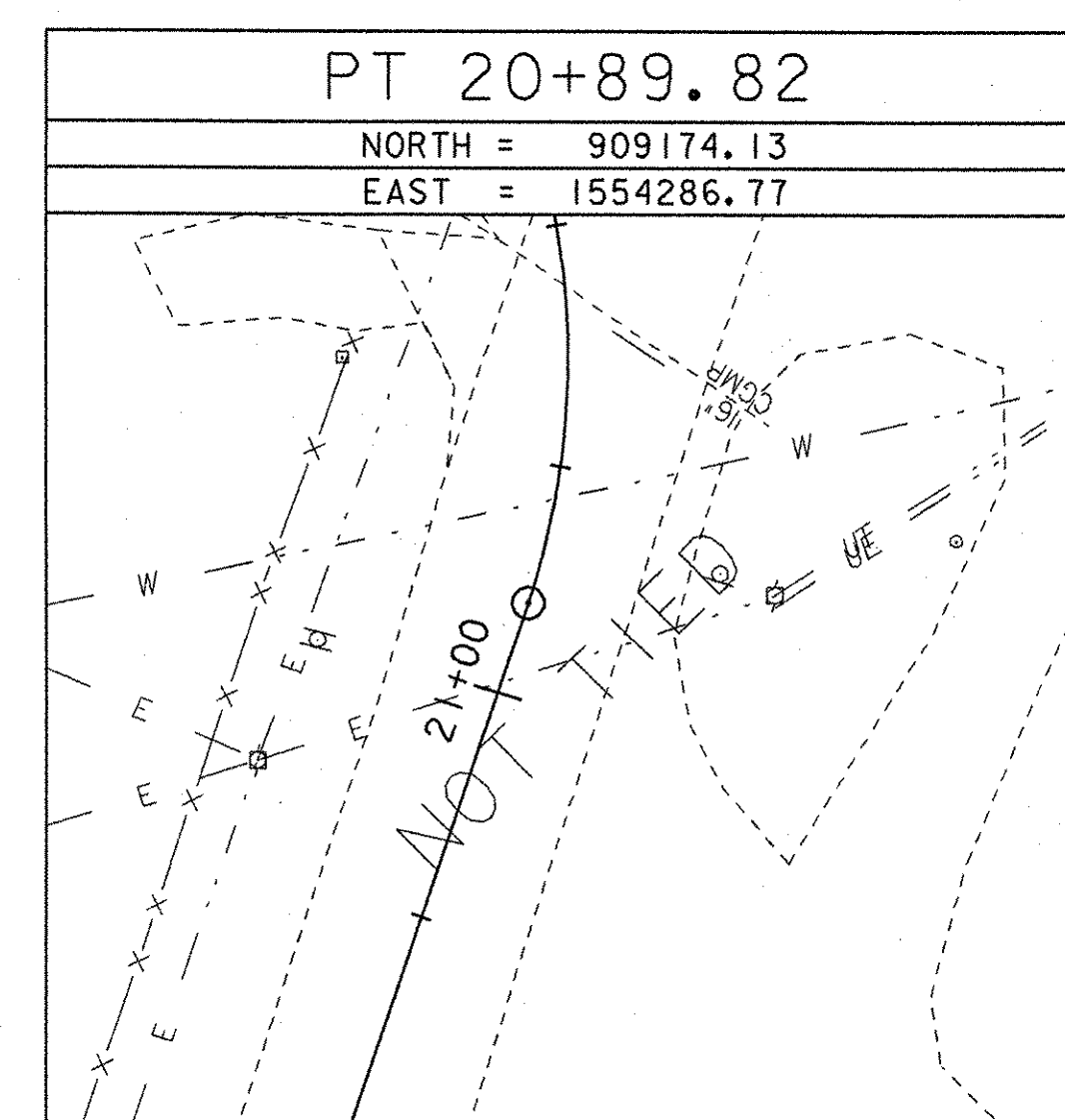
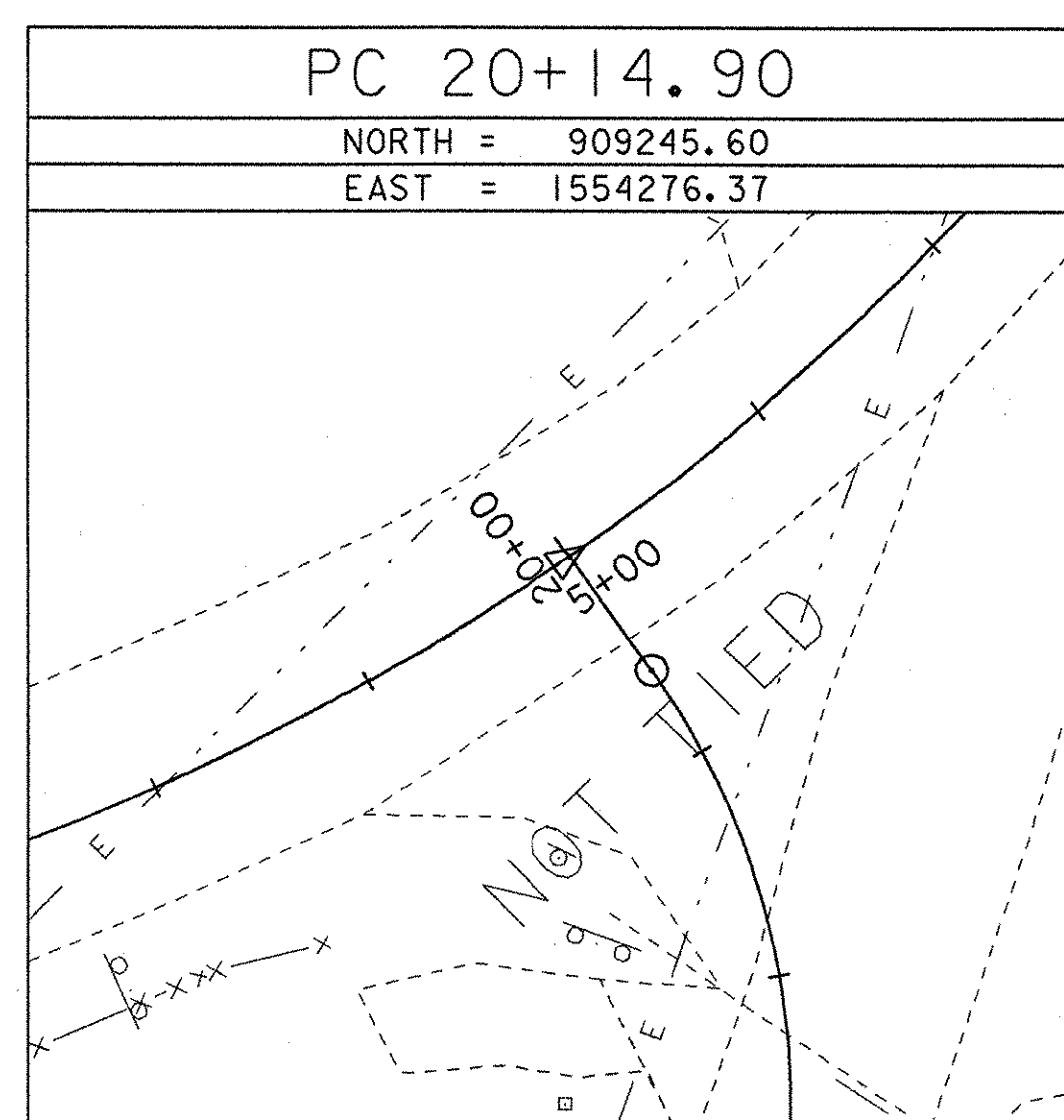
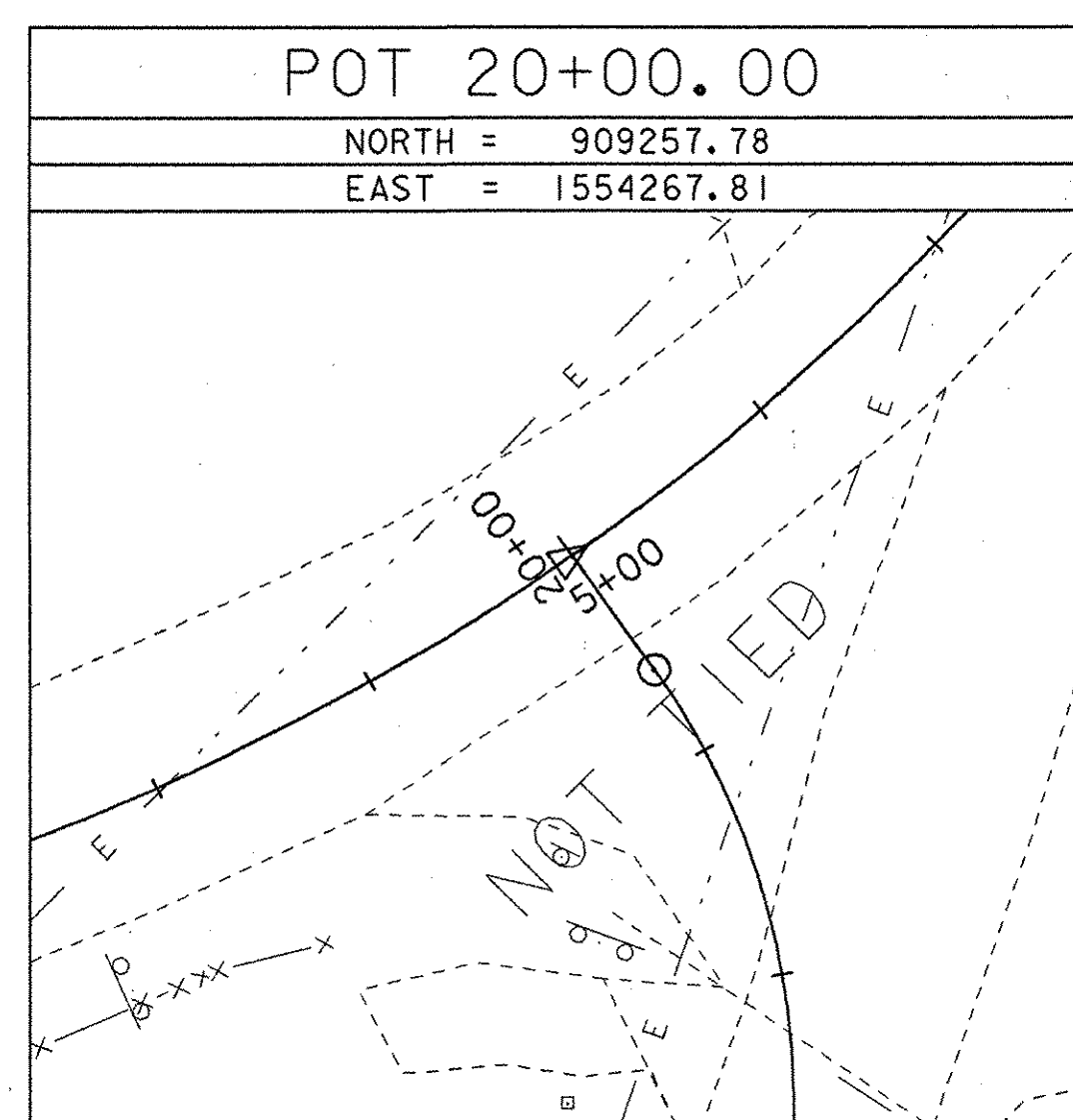
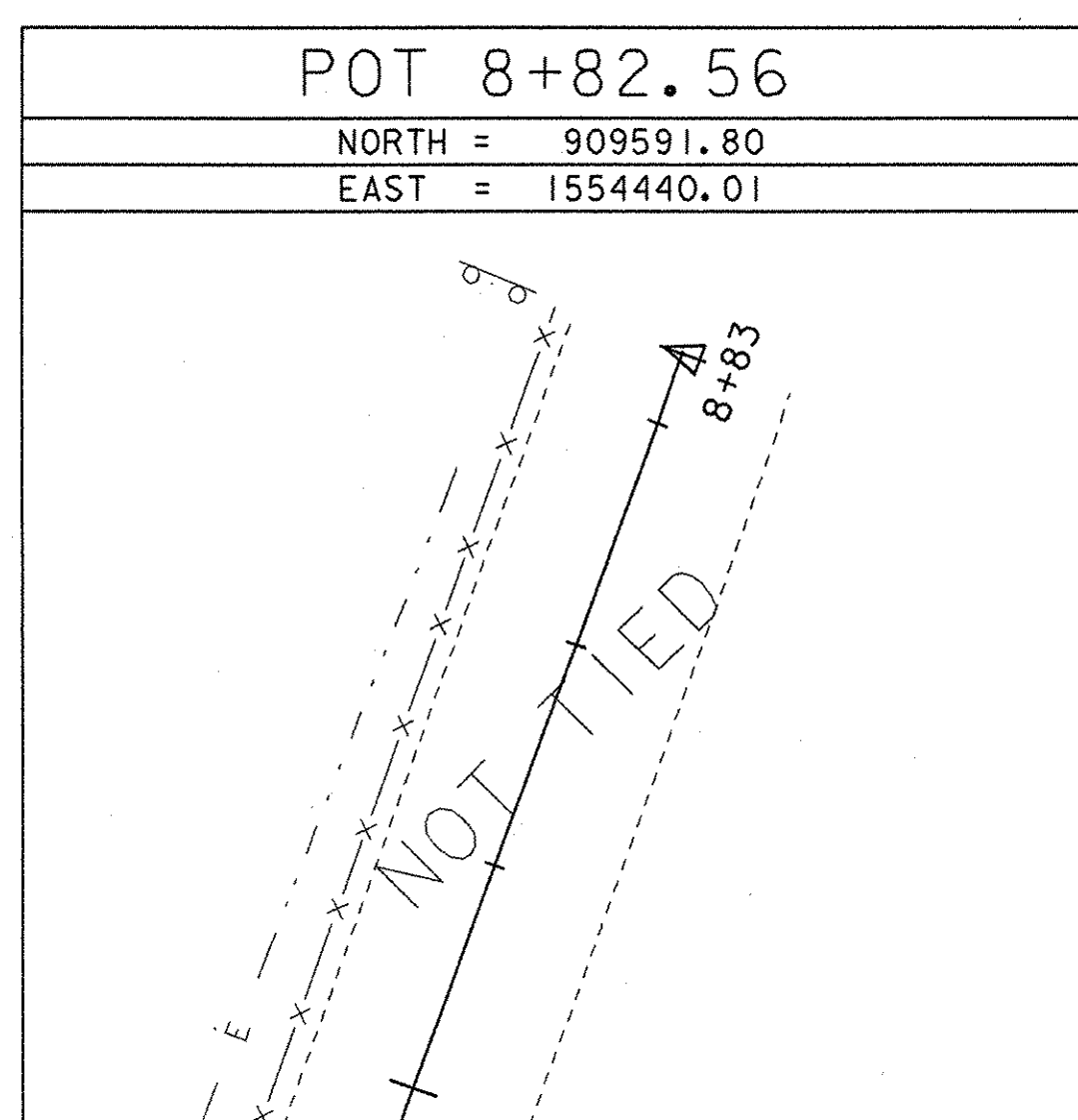

DATUM
 VERTICAL: NAVD 88
 HORIZONTAL: NAD83

PROJECT NAME:	FRANKLIN	PLOT DATE:	11-OCT-2006
PROJECT NUMBER:	HES 0313(4)	DRAWN BY:	MJF
FILE NAME:	Z04C2021.DGN	CHECKED BY:	DMB
PROJECT LEADER:	GAMBLE	TIE SHEET	SHEET II OF 26
DESIGNED BY:	BRC		