

DELINEATOR TYPICAL
 DELINEATORS SHALL BE REFLECTORIZED WHITE IN COLOR. THEY SHALL HAVE A MINIMUM OF 7 SQUARE INCHES. THEY MAY BE ROUND, SQUARE, OR OBLONG.

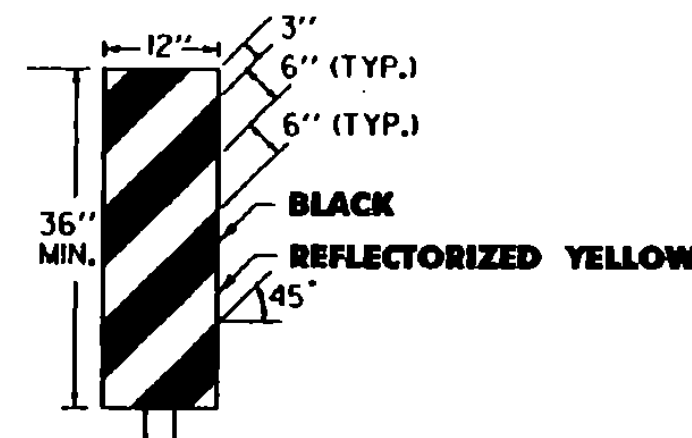

OBJECT MARKER TYPICAL

OBJECTS MARKERS ARE USED TO MARK OBSTRUCTIONS WITHIN OR ADJACENT TO THE ROADWAY. IN SOME CASES THERE MAY NOT BE A PHYSICAL OBJECT INVOLVED, BUT OTHER ROADSIDE CONDITIONS SUCH AS NARROW SHOULDER DROP-OFFS, GORES, D.I. EXCAVATIONS, AND ABRUPT CHANGES IN THE ROADWAY ALIGNMENT MAY MAKE IT UNDESIRABLE FOR A DRIVER TO LEAVE THE ROADWAY. THE INSIDE EDGE OF THE OBJECT MARKER SHALL BE IN LINE WITH THE INNER EDGE OF THE OBSTRUCTION, WHENEVER POSSIBLE. OBJECT MARKERS SHALL HAVE ALTERNATING BLACK AND REFLECTORIZED YELLOW STRIPES. (SLOPING DOWNWARD IN THE DIRECTION TRAFFIC IS TO PASS).

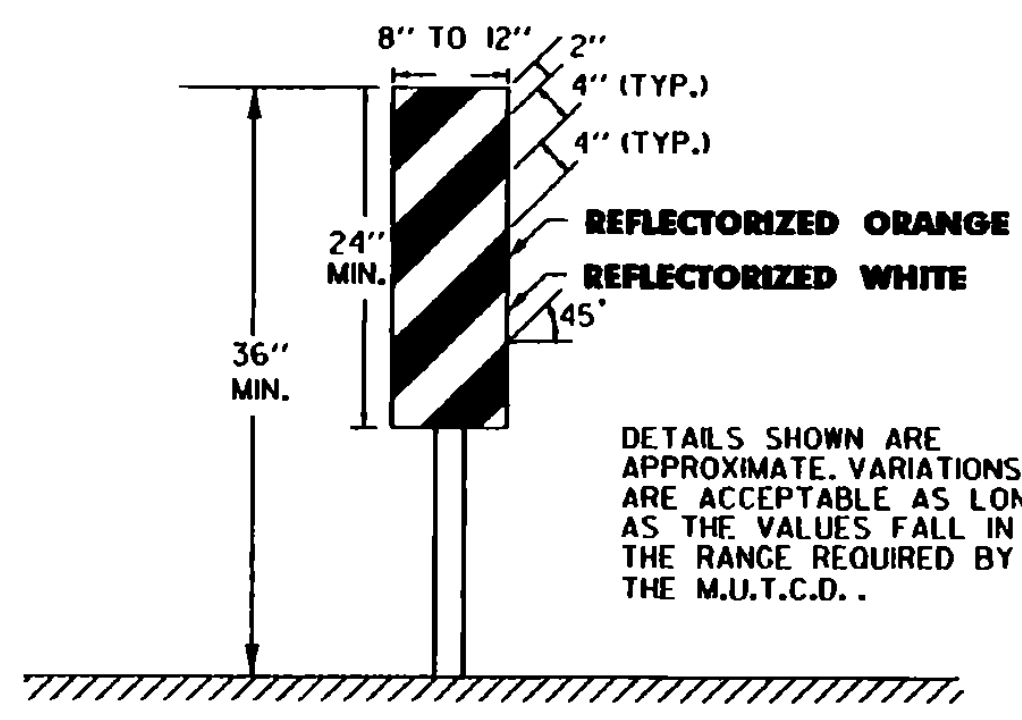

VERTICAL PANEL

DETAILS SHOWN ARE APPROXIMATE. VARIATIONS ARE ACCEPTABLE AS LONG AS THE VALUES FALL IN THE RANGE REQUIRED BY THE M.U.T.C.D..
 VERTICAL PANELS SHALL HAVE ALTERNATING ORANGE AND WHITE REFLECTORIZED STRIPES (SLOPING DOWNWARD IN THE DIRECTION TRAFFIC IS TO PASS). THESE DEVICES MAY BE USED FOR TRAFFIC SEPARATION, CHANNELIZING OR BARRICADING WHERE SPACE IS AT A MINIMUM.

DELINEATOR, VERTICAL PANEL AND OBJECT MARKER DETAILS FOR CONSTRUCTION AREAS WHERE TRAFFIC IS MAINTAINED

ALL SIGN PLACEMENT DISTANCES ARE DESIRABLE SPECIFICATIONS. FIELD CONDITIONS SHALL CONTROL THE ACTUAL PLACEMENT. PROJECT CONSTRUCTION APPROACH SIGNING PLACEMENT SHALL TAKE INTO CONSIDERATION SPACING REQUIREMENTS FOR THE DETOUR SIGN LAYOUT REQUIREMENTS.

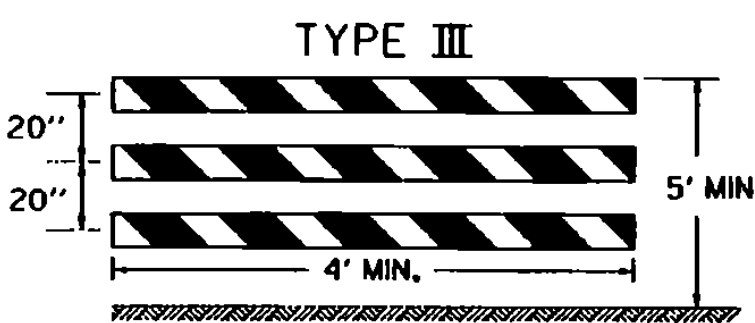
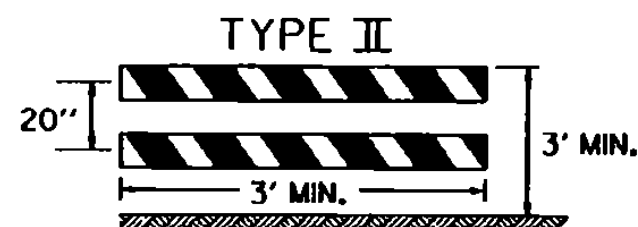
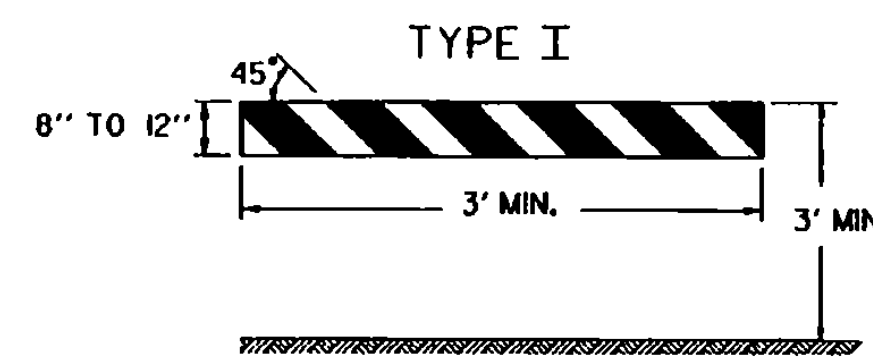

A TYPE III (MODIFIED) BARRICADE SHALL CONSIST OF TYPE B RAILS MOUNTED ON A BREAKAWAY BARRICADE AS SHOWN ON STANDARD SHEET E-107A.

| BARRICADE CHARACTERISTICS | | | |
|---------------------------|-------------------------|-------------------------|-------------------------|
| | I | II | III |
| WIDTH OF RAIL | 8" MIN. 12" MAX. | 8" MIN. 12" MAX. | 8" MIN. 12" MAX. |
| LENGTH OF RAIL | 3' MIN. | 3' MIN. | 4' MIN. |
| WIDTH OF STRIPES | 6" | 6" | 6" |
| HEIGHT | 3' MIN. | 3' MIN. | 5' MIN. |
| TYPE OF FRAME | SEE E-107A | SEE E-107A | SEE E-107A |
| FLEXIBILITY | PORTABLE | PORTABLE | PORTABLE |
| ANGLE OF STRIPE | 45° | 45° | 45° |
| COLOR OF STRIPES | ORANGE AND ORANGE WHITE | ORANGE AND ORANGE WHITE | ORANGE AND ORANGE WHITE |

BARRICADE CHARACTERISTICS

| DETOUR DESIGN SPEED (M.P.H.) | MINIMUM RADIUS (FT.) ^a | | | | |
|------------------------------|-----------------------------------|------|------|------|------|
| | SUPERELEVATION (FT./FT.) | | | | |
| | 0.00 ^b | 0.02 | 0.04 | 0.06 | 0.08 |
| 20 | 160 | 140 | 130 | 120 | 110 |
| 25 | 245 | 220 | 200 | 185 | 170 |
| 30 | 375 | 335 | 305 | 275 | 255 |
| 35 | 510 | 455 | 410 | 375 | 340 |
| 40 | 715 | 630 | 575 | 510 | 470 |
| 50 | 1190 | 1045 | 955 | 850 | 765 |

a. PER AASHTO REQUIREMENTS
 b. 0.00 SUPERELEVATION SHOULD BE AVOIDED IF POSSIBLE

BARRICADES

APPLICATION NOTES

TYPE I BARRICADES SHALL BE USED ON CONVENTIONAL ROADS OR URBAN STREETS AND ARTERIALS TO MARK A SPECIFIC HAZARD.

TYPE II BARRICADES SHALL BE USED ON EXPRESSWAYS AND FREEWAYS, SERVING THE SAME FUNCTIONS AS TYPE I BARRICADES.

TYPE III BARRICADES (SEE STD. E-107A) SHALL ONLY BE USED WHEN A ROAD SECTION OR LANE IS CLOSED TO TRAFFIC AND ARE TO BE ERECTED AT THE POINT OF CLOSURE.

MATERIALS

THE BARRICADES SHOWN ON THIS SHEET SHOULD BE OF LIGHTWEIGHT MATERIAL. IF WOOD IS USED THE FOLLOWING CONDITIONS SHALL APPLY:

- WOODEN BARRICADES (TYPE I AND II)
 - SHALL NOT BE USED TO CHANNELIZE OR DELINEATE WORK AREAS WITHIN THE CLEAR ZONE OF ANY HIGHWAY WHERE OPERATING SPEEDS IN EXCESS OF 20 M.P.H. ARE EXPECTED UNLESS INSTALLED FOR PEDESTRIAN CONTROL BEHIND APPROVED POSITIVE BARRIERS.
 - MAY BE USED WHERE OPERATING SPEEDS OF 20 M.P.H. OR LESS ARE EXPECTED.
- TYPE III WOODEN BARRICADES SHALL NOT BE USED.

COLORS

THE BARRICADE PANELS SHOWN ON THIS SHEET SHALL HAVE AN ALTERNATING REFLECTORIZED WHITE AND ORANGE STRIPES. THE ORANGE SHALL CONFORM WITH THE STANDARD COLORS ADOPTED BY THE AMERICAN ASSOCIATION OF STATE HIGHWAY AND TRANSPORTATION OFFICIALS AND APPROVED BY THE U.S. DEPARTMENT OF TRANSPORTATION FEDERAL HIGHWAY ADMINISTRATION. THE BARRICADE COMPONENTS SHALL BE WHITE UNLESS UNPAINTED METAL OR ALUMINUM IS USED.

REFLECTORIZATION

THE REFLECTIVE SHEETING ON BARRICADE PANELS SHALL BE TYPE III.

LOCATION

THE BARRICADES SHOWN ON THIS SHEET WILL BE LOCATED BY THE RESIDENT ENGINEER IN THE FIELD OR AS SHOWN ON THE PLANS. THE LOCATION OF THE BARRICADES SHALL FOLLOW THE PROCEDURES SET FORTH IN THE "MANUAL ON UNIFORM TRAFFIC CONTROL DEVICES", OR AS OTHERWISE NOTED.

MAINTENANCE

BARRICADES SHALL BE MAINTAINED IN CLEAN CONDITION, SATISFACTORY TO THE RESIDENT ENGINEER. THEY SHALL BE COMPLETELY VISIBLE TO THE APPROACHING TRAFFIC AT ALL TIMES. DAMAGED, DEFACED, OR DIRTY BARRICADES SHALL BE REPAIRED, CLEANED, OR REPLACED AS ORDERED BY THE RESIDENT ENGINEER.

DETOUR NOTES

- SIGNS AND DELINEATION SHOWN FOR ONE DIRECTION OF TRAFFIC ONLY.
- THE CONTRACTOR IS RESPONSIBLE FOR PAVEMENT MARKING AND SHALL REMOVE ANY CONFLICTING OR CONFUSING EXISTING MARKINGS.
- ADDITIONAL SIGNING MAY BE REQUIRED AT THE DISCRETION OF THE RESIDENT ENGINEER.
- UNPAVED DETOURS REQUIRE PAVEMENT MARKINGS FOR TRANSITIONS FROM EXISTING PAVEMENT.
- THE NUMBER OF CHANNELIZING DEVICES, BARRICADES AND OTHER TRAFFIC CONTROL DEVICES SHOWN ON THIS SHEET ARE FOR ILLUSTRATIVE PURPOSES ONLY. THE ACTUAL NUMBER REQUIRED SHALL BE DETERMINED BASED ON INDIVIDUAL DETOUR CONDITIONS (TAPERS, SPEED LIMITS, LENGTH OF DETOUR CURVE, ETC.).
- AASHTO CLEAR ZONE REQUIREMENTS SHOULD BE MET. IF NOT THEN AN APPROVED ENERGY ABSORPTION ATTENUATOR SUITABLE FOR THE TEMPORARY TRAFFIC BARRIER USED AND FOR THE DESIGN SPEED SHALL BE INSTALLED PER THE CURRENT AASHTO ROADSIDE DESIGN GUIDE.
- THE DETOUR DESIGN SPEED SHOULD BE NO LESS THAN 10 M.P.H. BELOW THE POSTED SPEED LIMIT, UNLESS PHYSICAL RESTRICTIONS PREVENT THIS.
- SEE STANDARD SHEETS E-100, E-101 AND E-102 FOR SIGN DETAIL AND MATERIAL REQUIREMENTS.
- IF THE USE OF TEMPORARY TRAFFIC BARRIER IS NOT REQUIRED, THEN REFLECTORIZED PLASTIC DRUMS SHALL BE USED.

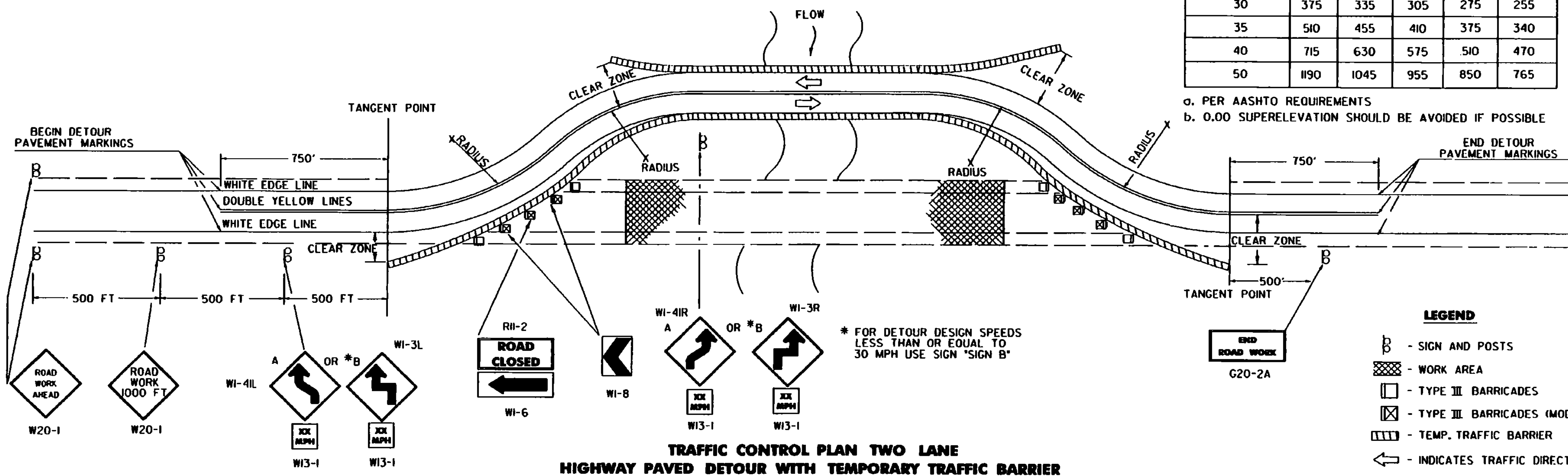

TRAFFIC CONTROL PLAN TWO LANE HIGHWAY PAVED DETOUR WITH TEMPORARY TRAFFIC BARRIER

REVISIONS AND CORRECTIONS

- SEPT. 10, 1987 - DATE OF ORIGINAL ISSUE
- APRIL 29, 1988 - FHWA REVIEW COMMENTS
- SEPT. 20, 1993 - NEW RADIUS CHART, BARRICADE ALIGNMENT AND USE OF TEMPORARY TRAFFIC BARRIER
- AUG. 08, 1995 - REVISED SIGNING PER MUTCD

APPROVED FOR THIS PROJECT AND/OR DESIGN IMPLEMENTATION. FHWA FINAL APPROVAL PENDING.

APPROVED

Stephen D. MacAllen
 DIRECTOR OF ENGINEERING

David A. Ross
 TRAFFIC AND SAFETY ENGINEER

DELINEATION, BARRICADES AND DETOURS FOR CONSTRUCTION AREAS

OTHER STDS. REQUIRED: E-100 E-101 E-102 E-102a E-107a

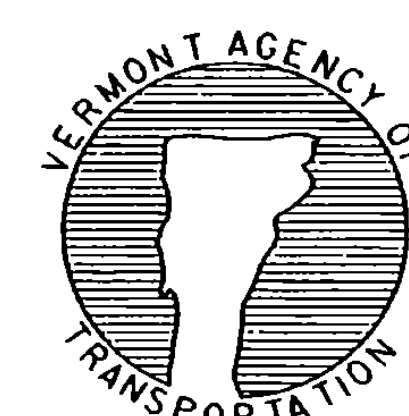

STANDARD E-107