

- INDEX OF SHEETS**
1. TITLE SHEET
 2. LOCATION MAPS SHEET
 3. GENERAL NOTES SHEET
 4. BRIDGE INFORMATION SHEET
 5. QUANTITY SHEET

- VAOT STANDARD SHEETS**
- E - 100A 01-06-97
 - E - 102 08-08-95
 - E - 102A 08-08-95
 - E - 107 08-08-95
 - E - 107A 08-08-95

STATE OF VERMONT AGENCY OF TRANSPORTATION



PROPOSED IMPROVEMENT BRIDGE PROJECT

STATEWIDE - NORTH REGION BHO HBRP(9)

PROJECT DESCRIPTION
REMOVE EXISTING METAL ROOF AND REPLACE WITH STANDING SEAM METAL ROOF FOR 9 COVERED BRIDGES.

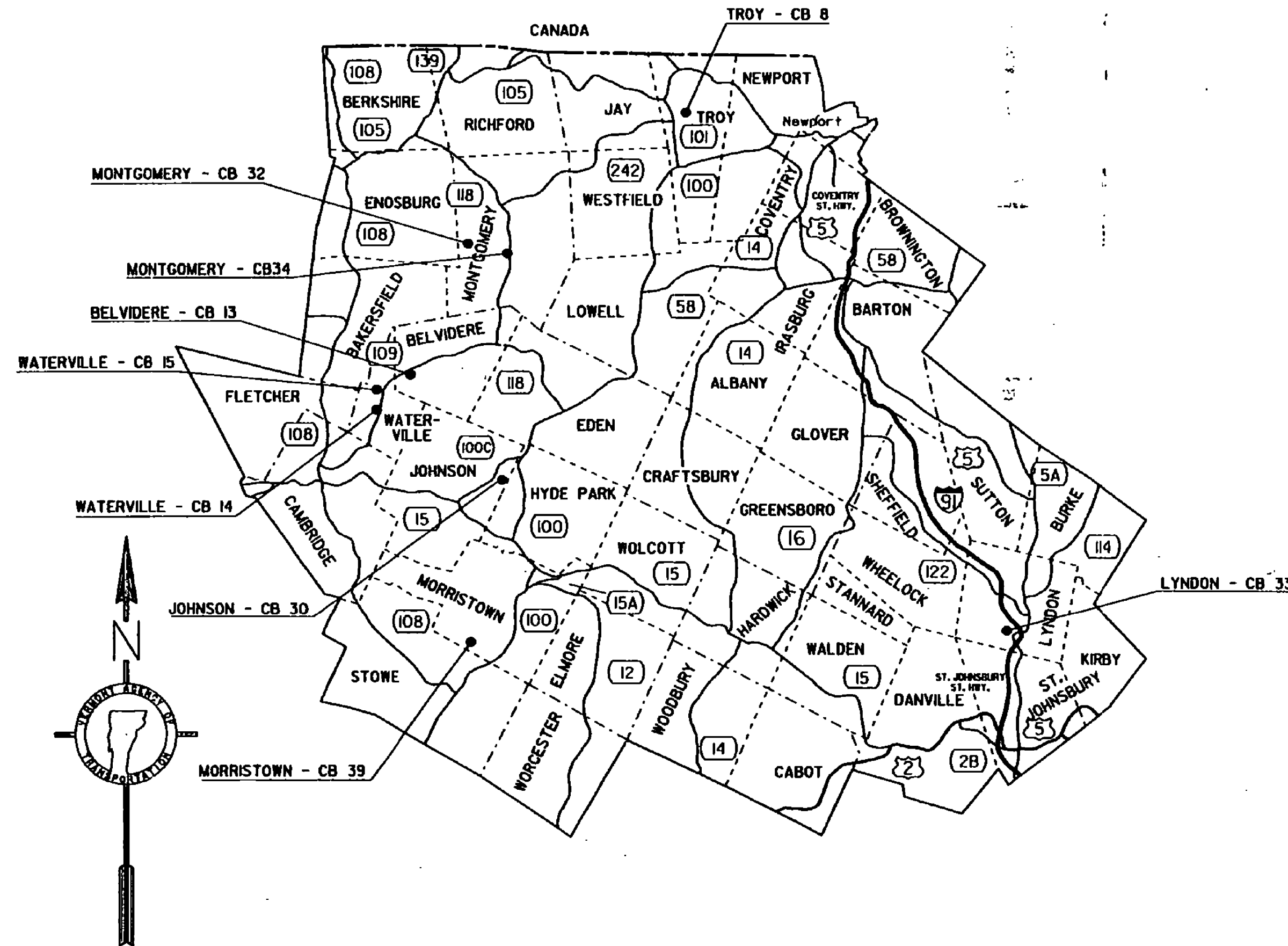

CONVENTIONAL SYMBOLS

COUNTY LINE	
TOWN LINE	
LIMITS OF ACCESS	
POINT OF ACCESS	
FENCE LINE	
STONE WALL	
TRAVELED WAY	
GUARD RAIL	
RAILROAD	
SURVEY LINE	
CULVERT	
POWER POLE	
TELEPHONE POLE	
TREES	
CONTROL OF ACCESS	
PROPERTY LINE	
R.O.W. TAKING LINE	
SLOPE RIGHTS	
TOP OF CUT	
TOE OF SLOPE	

SURVEYED BY : N/A
SURVEYED DATE : N/A

DATUM
VERTICAL N/A
HORIZONTAL N/A

CONTRACT PLANS
THESE PLANS DO NOT REFLECT
CHANGES MADE ON THE PROJECT.

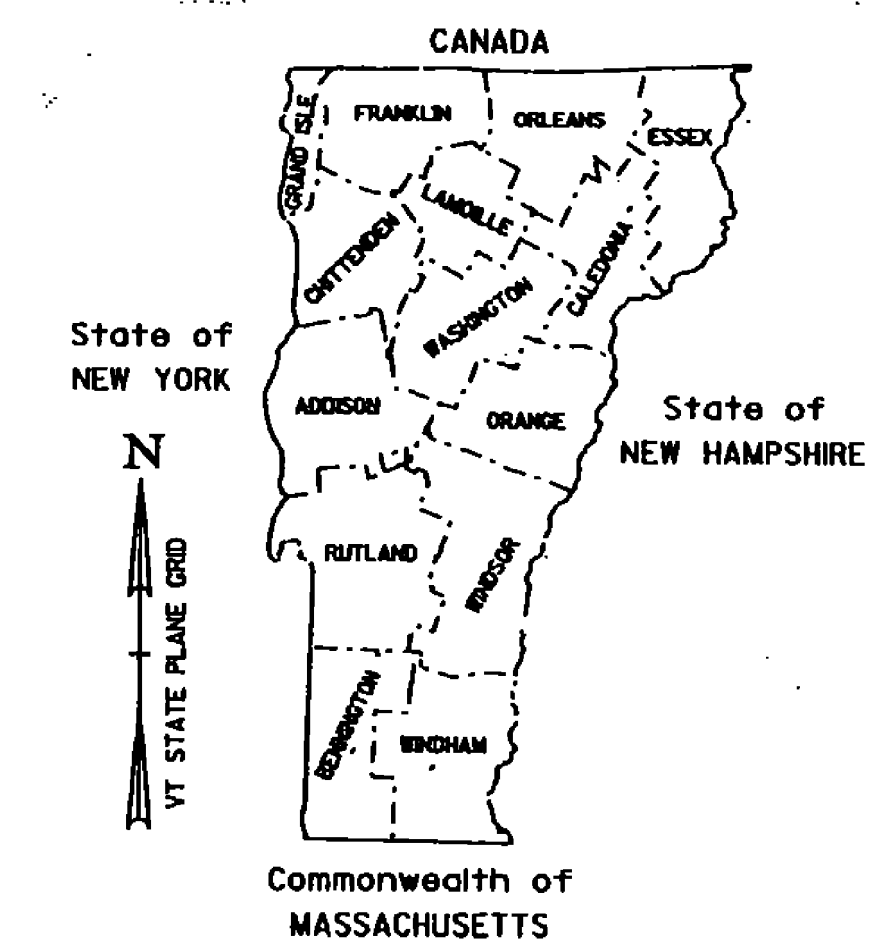

R.T.D. Enterprises
[Signature]
Contractor
[Signature]
Signature
President
Title

[Signature]
Director of Finance and Administration
or Duly Authorized Agent
7-15-02
Date

THESE PLANS ARE SUBJECT TO SUCH ENGINEERING CHANGES AS MAY BE REQUIRED BY THE FEDERAL HIGHWAY ADMINISTRATION OR THE DIRECTOR OF PROJECT DEVELOPMENT.
CONSTRUCTION IS TO BE CARRIED ON IN ACCORDANCE WITH THESE PLANS AND THE STANDARD SPECIFICATIONS FOR CONSTRUCTION DATED 2001, AS APPROVED BY THE FEDERAL HIGHWAY ADMINISTRATION ON JANUARY 4, 2001 FOR USE ON THIS PROJECT, INCLUDING ALL SUBSEQUENT REVISIONS AND SUCH REVISED SPECIFICATIONS AND SPECIAL PROVISIONS AS ARE INCORPORATED IN THESE PLANS.

DEPARTMENT OF TRANSPORTATION FEDERAL HIGHWAY ADMINISTRATOR	
APPROVED <i>[Signature]</i>	DATE 12-17-2002
DIRECTOR OF PROJECT DEVELOPMENT	
APPROVED <i>[Signature]</i>	DATE 1/16/02
PROJECT MANAGER : SUE SCRIBNER	
PROJECT NAME : STATEWIDE - NORTH REGION	
PROJECT NUMBER : BHO HBRP(9)	
SHEET 1 OF 5 SHEETS	

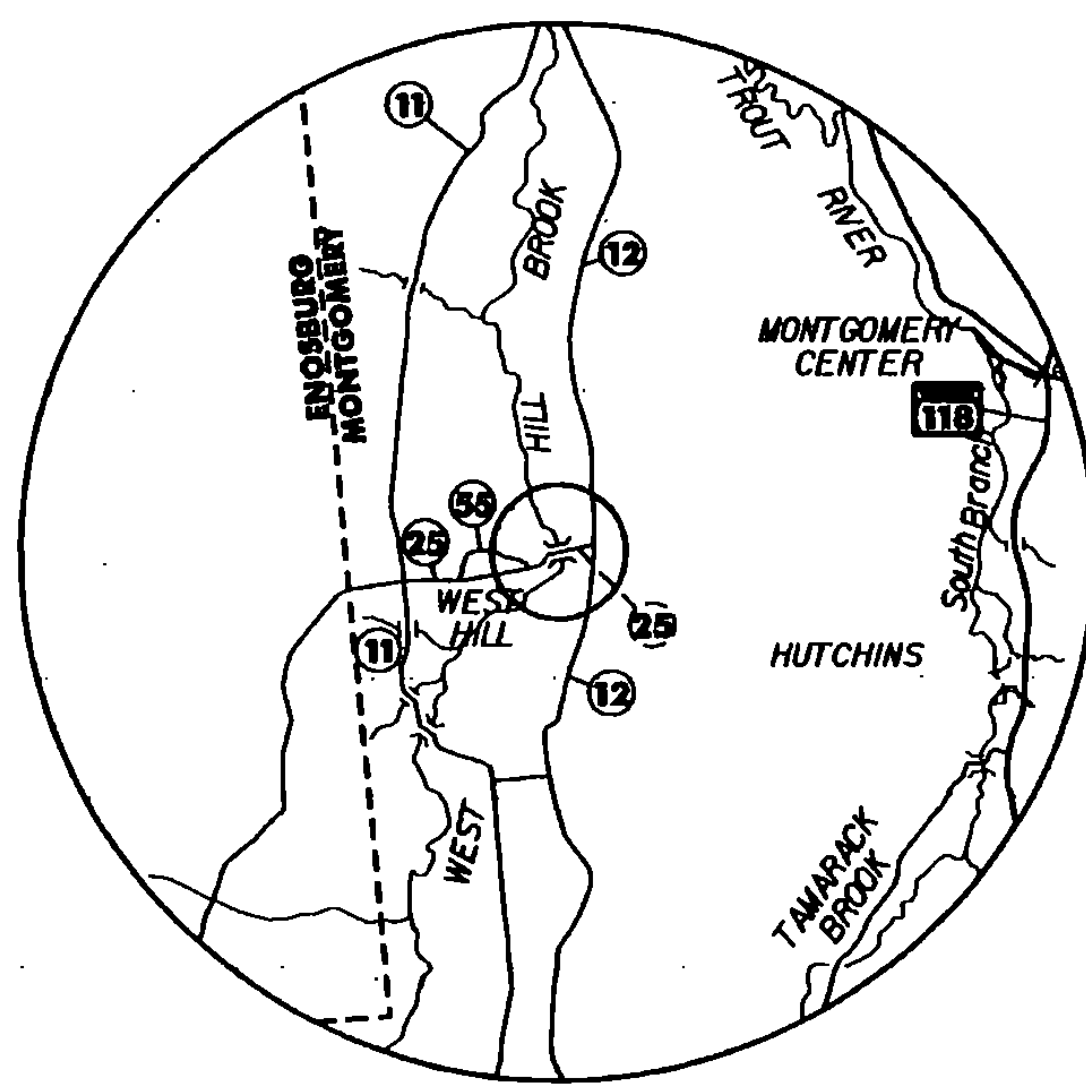

MONTGOMERY
WEST HILL (CREAMERY) COVERED BRIDGE
CB 32

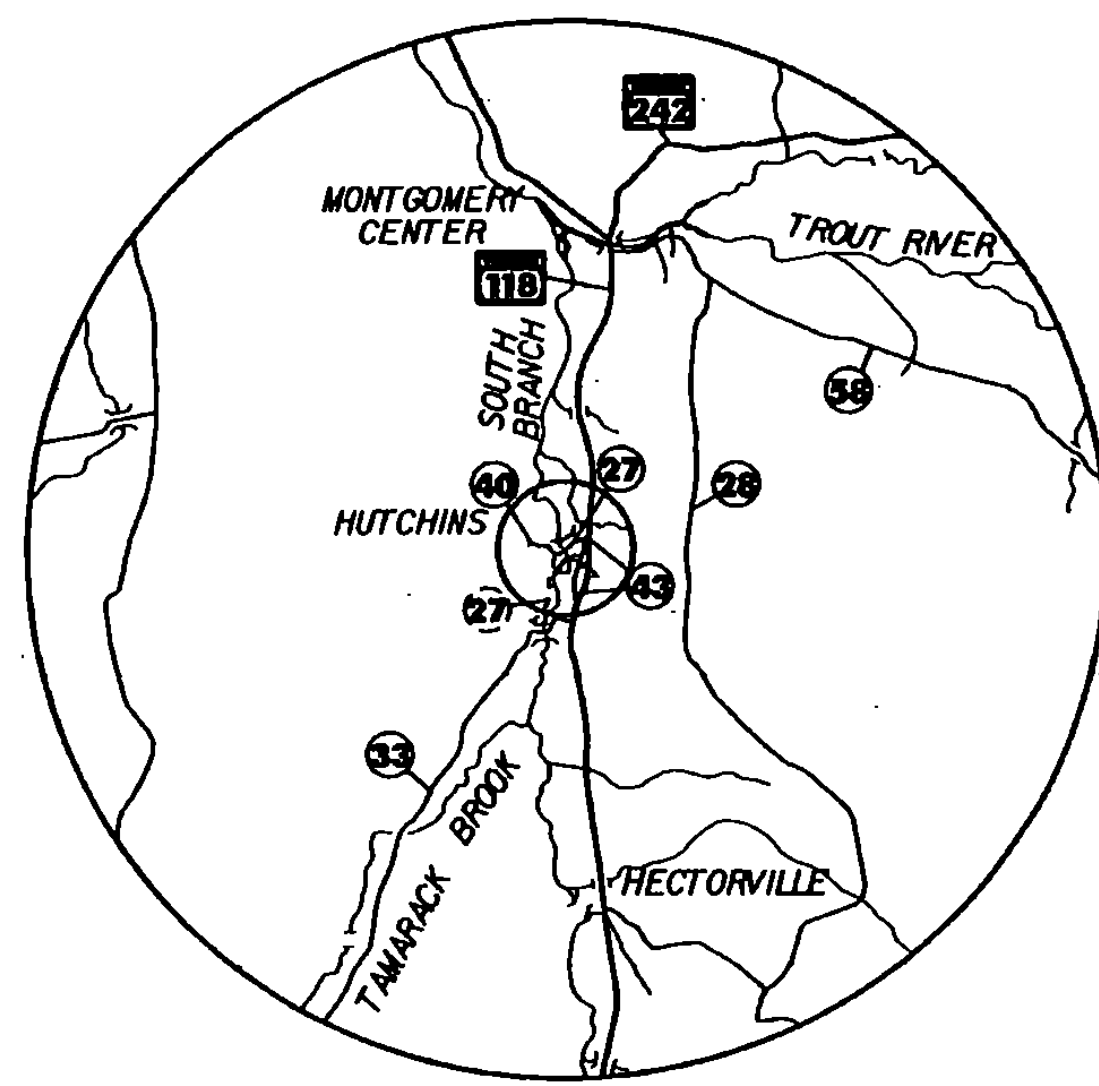

MONTGOMERY
HUTCHINS COVERED BRIDGE
CB 34

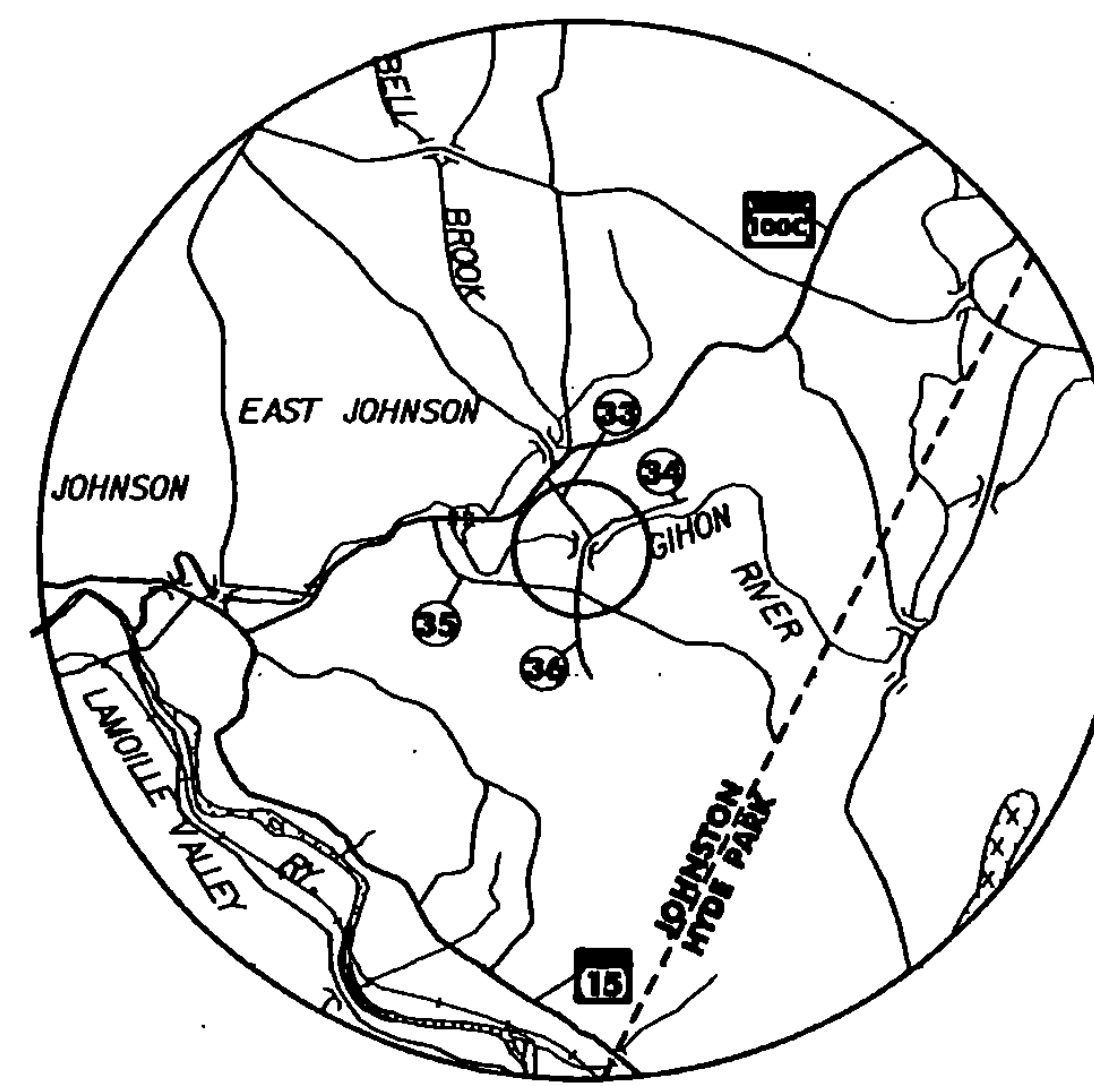
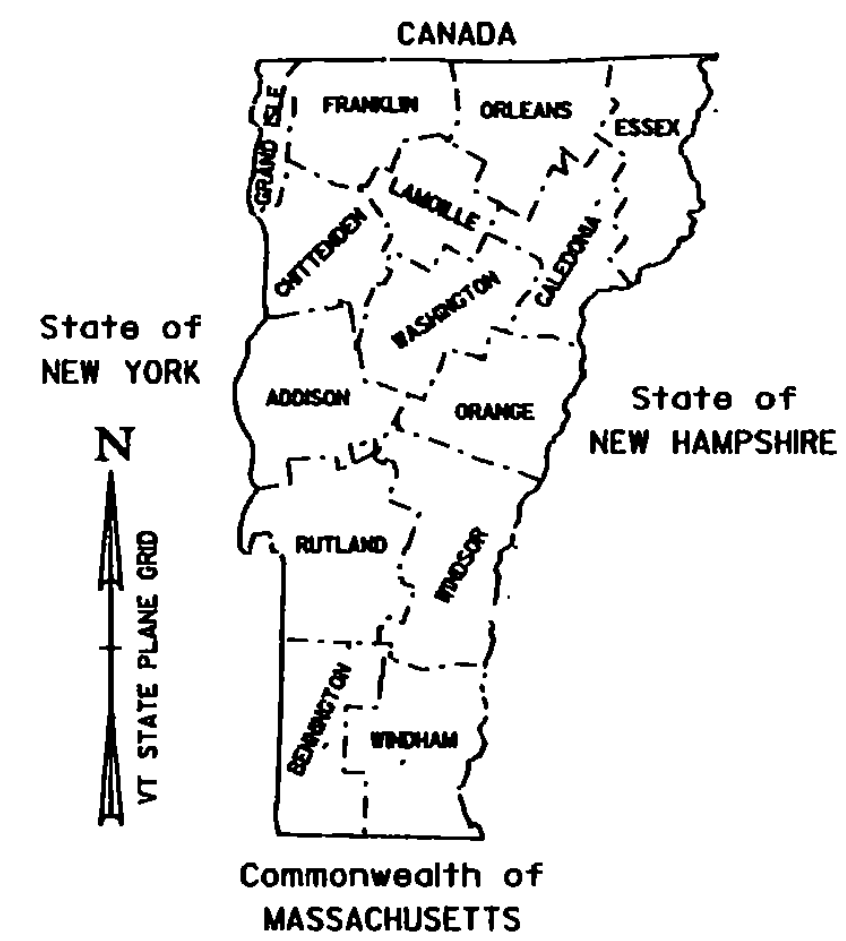

JOHNSON
SCRIBNER (MUGGET) COVERED BRIDGE
CB 30

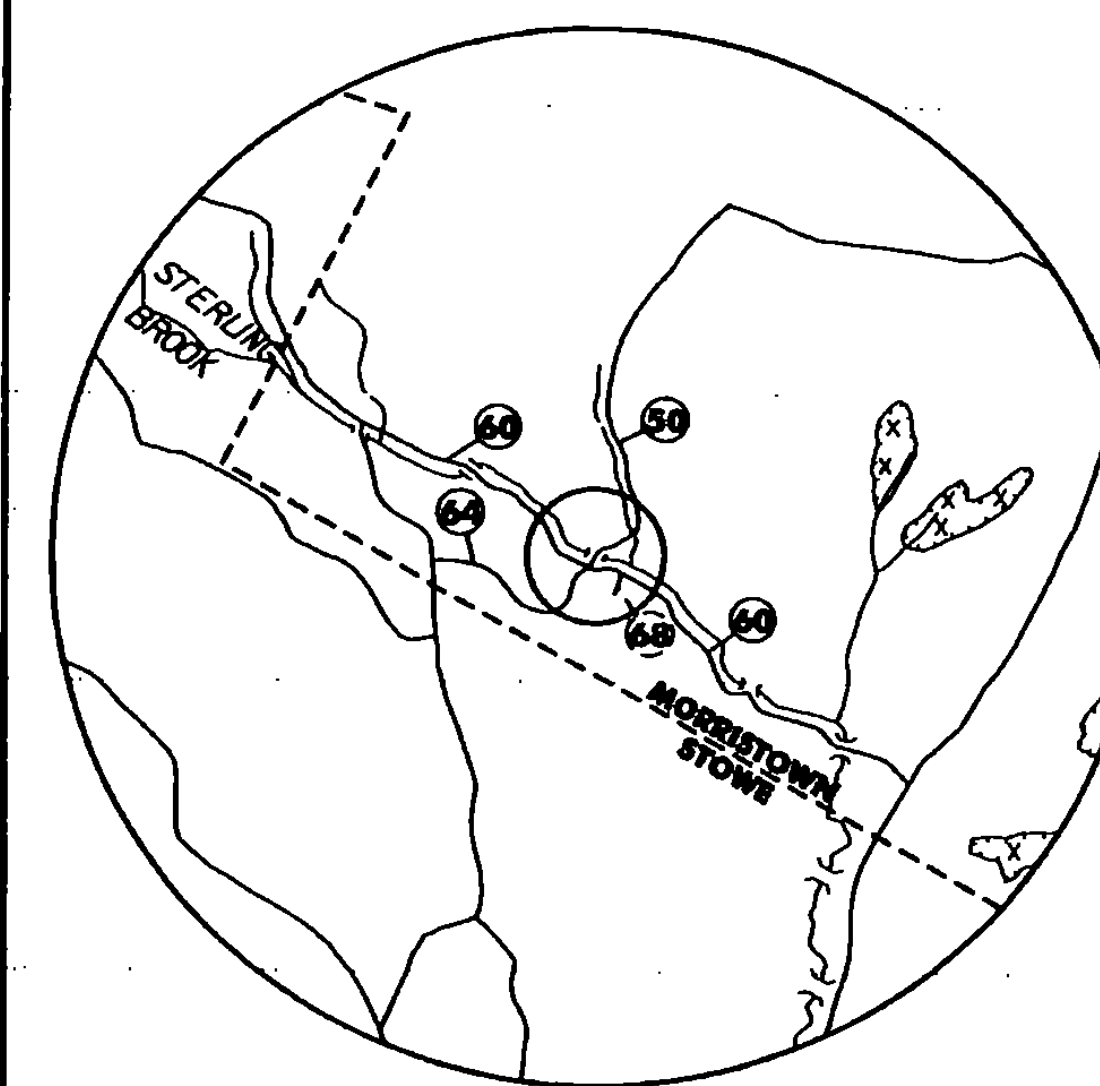

MORRISTOWN
RED COVERED BRIDGE
CB 39

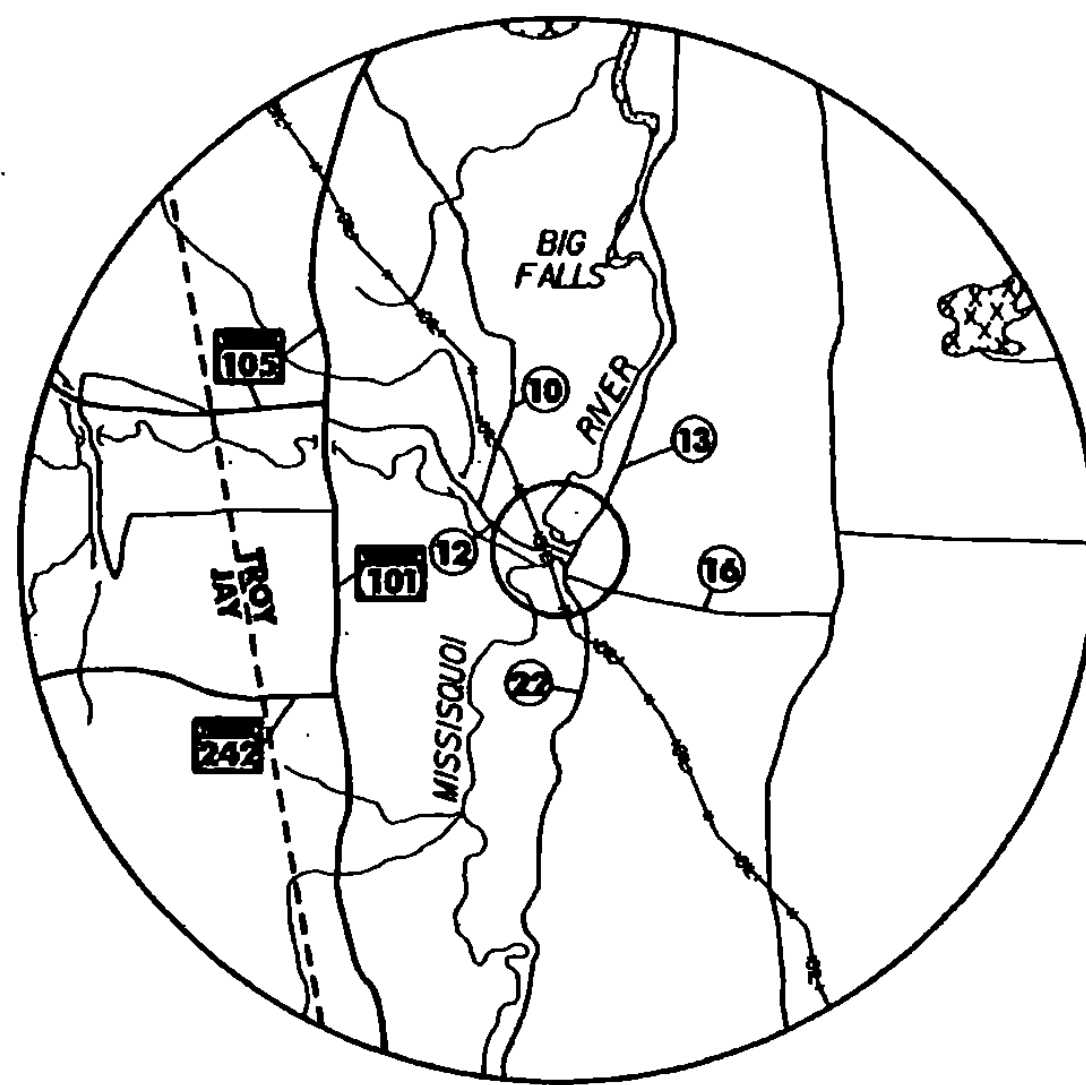

TROY
RIVER ROAD COVERED BRIDGE
CB 8

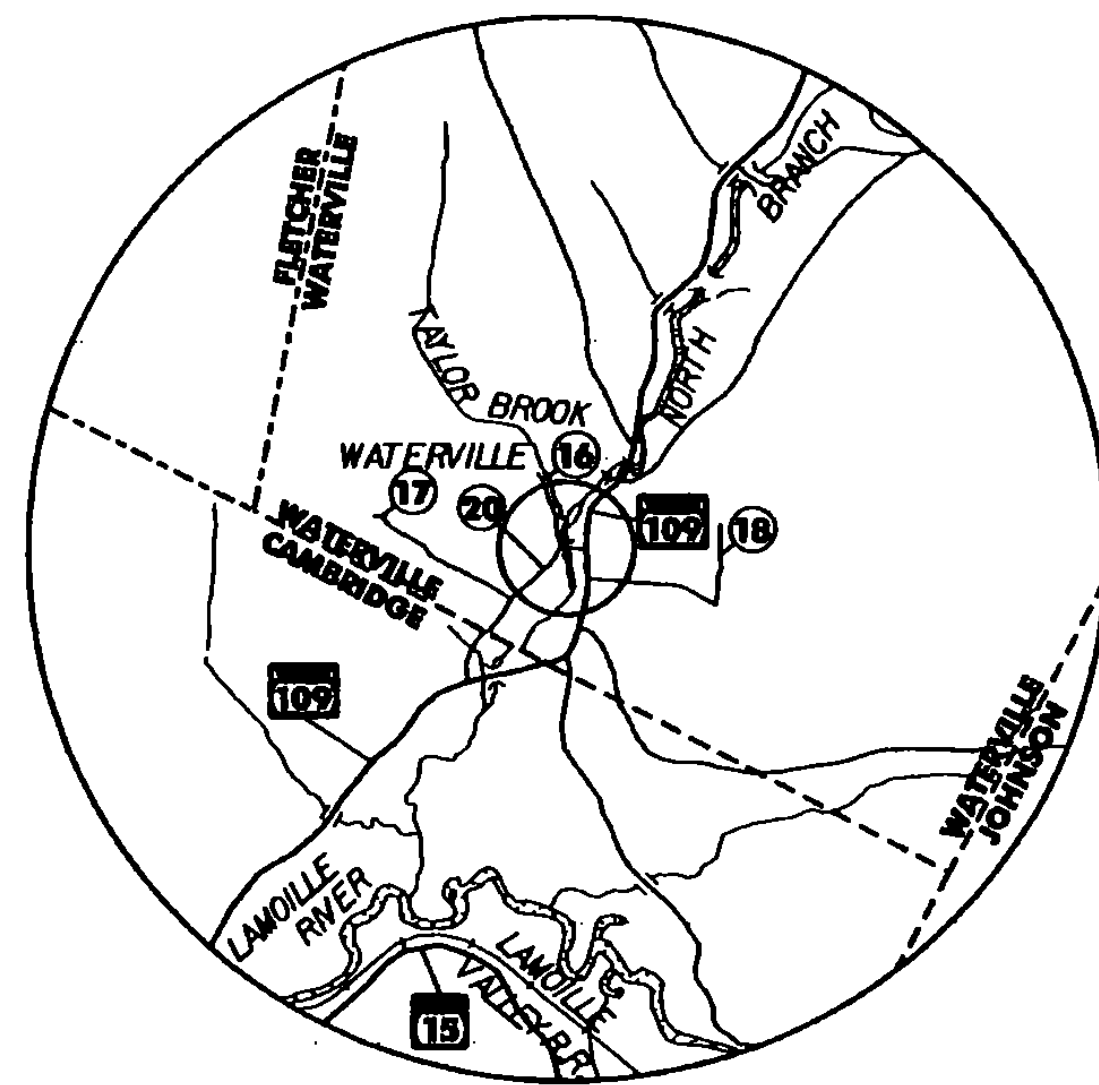

WATERVILLE
VILLAGE COVERED BRIDGE
CB 14

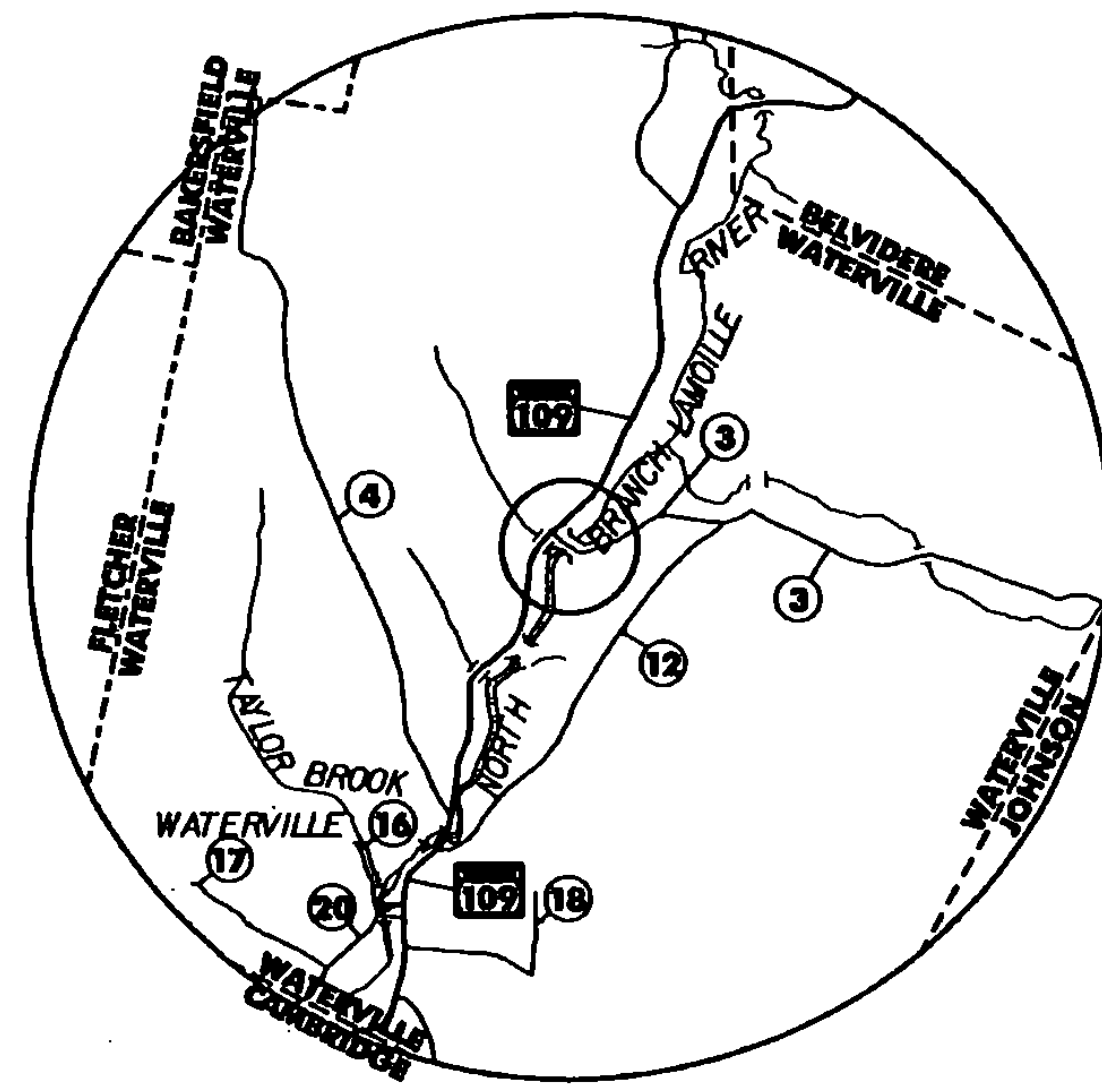

WATERVILLE
JAYNES COVERED BRIDGE
CB 15

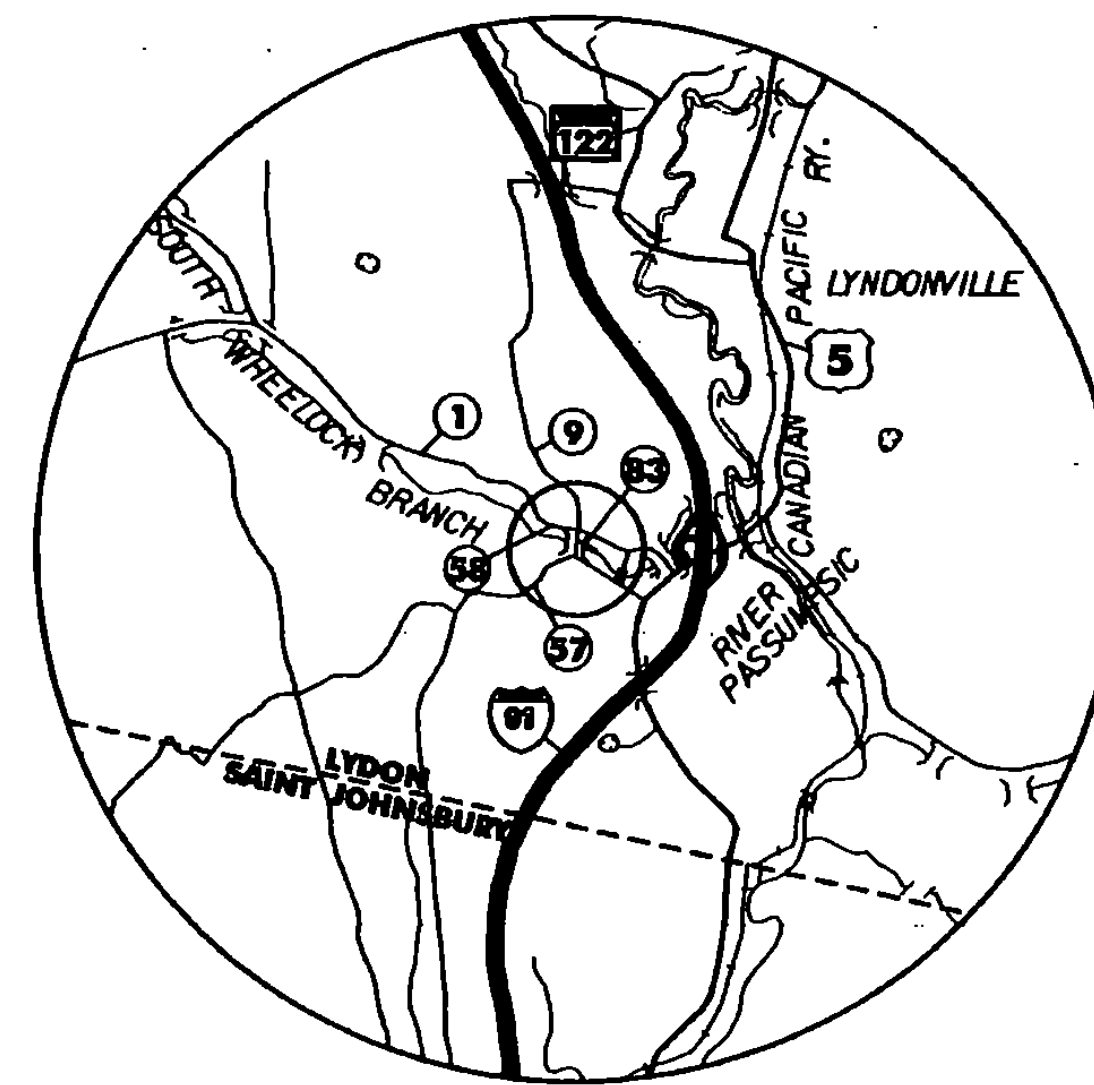

LYNDON
CHAMBERUN MILL COVERED BRIDGE
CB 33

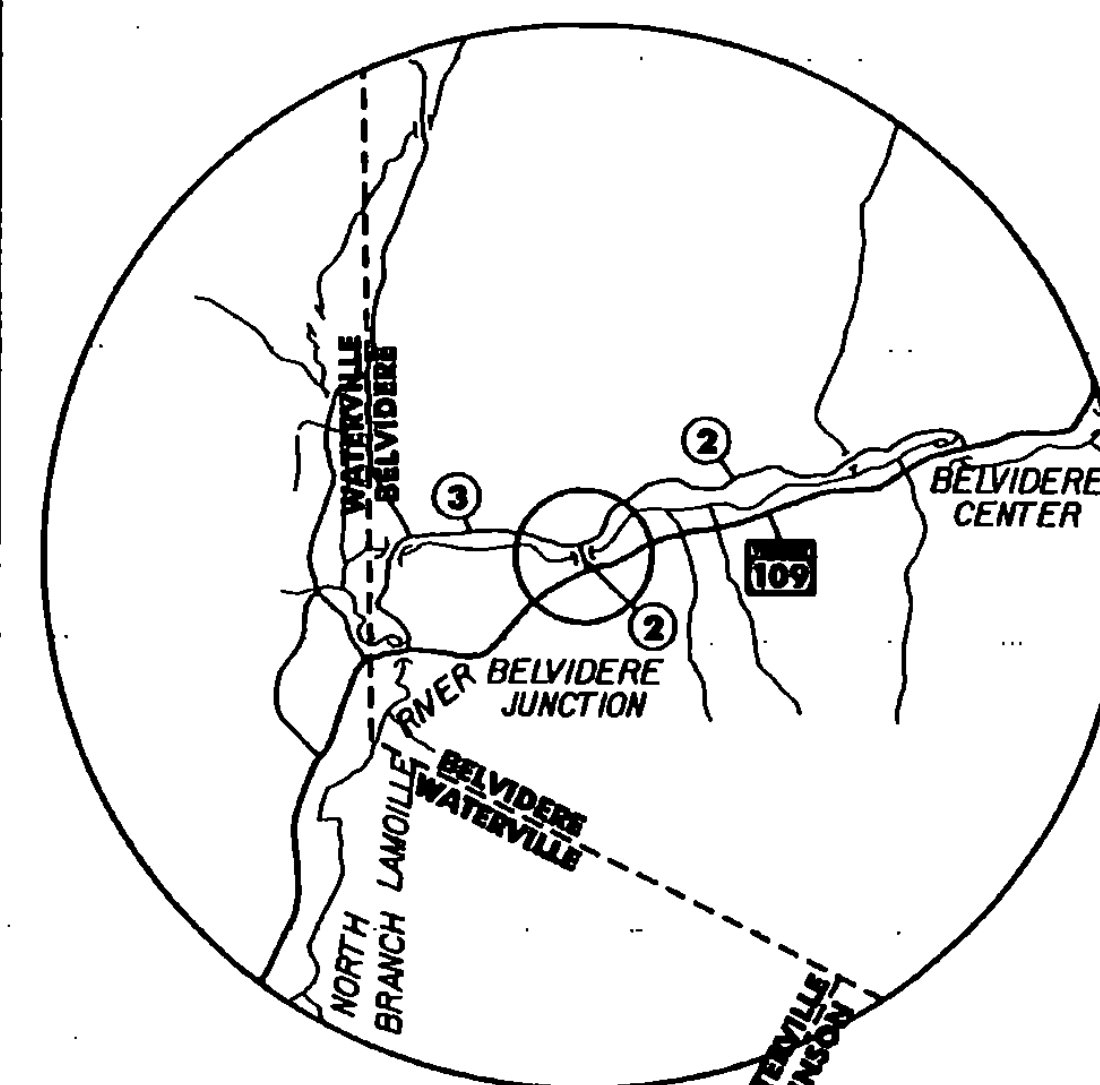

BELVIDERE
MORGAN (UPPER) COVERED BRIDGE
CB 13

PROJECT NAME: STATEWIDE - NORTH REGION
 PROJECT NUMBER: BHO HBRP(9)
 FILE NAME: /00j250/str/sj250map.dgn
 PROJECT LEADER: SUE SCRIBNER
 DESIGNED BY: M. GAGULIC
 sj250map-09.1
 PLOT DATE: 09-MAY-2002
 DRAWN BY: R. PELLETT
 CHECKED BY: M. GAGULIC
 SHEET 2 OF 5

GENERAL NOTES

1. ALL MATERIALS AND CONSTRUCTION SHALL CONFORM TO THE STATE OF VERMONT AGENCY OF TRANSPORTATION STANDARD SPECIFICATIONS FOR CONSTRUCTION DATED 2001 ITS LATEST REVISIONS AND THE AASHTO STANDARD SPECIFICATIONS FOR HIGHWAY AND BRIDGES DATED 1996 AND ITS LATEST REVISIONS.
2. ALL INFORMATION PROVIDED IN THE PLANS SHALL BE CHECKED AND VERIFIED PRIOR TO COMMENCING THE WORK.
3. THE ITEM NON-STRUCTURAL LUMBER - UNTREATED (522.30) SHALL BE USED TO REPLACE ROTTEN OR DAMAGED ROOF SHEATHING. THE QUANTITIES SHOWN ON SHEET 5 ARE ESTIMATES BASED ON VISUAL INSPECTION. THE LUMBER USED SHALL BE SPECIES = EASTERN SPRUCE, GRADE NO. 1 OR BETTER. THE MATERIAL USED SHALL BE ROUGH SAWN AND CLOSELY RESEMBLE THE DIMENSIONS (WIDTH AND THICKNESS) OF MATERIAL BEING REPLACED. GALVANIZED WOOD SCREWS SHALL BE USED; PAYMENT TO BE SUBSIDIARY TO ITEM 522.30.
4. THE ITEM 665.15 "REMOVE EXISTING ROOFING" INCLUDES THE COST OF REMOVING THE METAL ROOF AS WELL AS ANY UNSUITABLE SHEATHING, OR OTHER DECAYED ROOF MEMBERS AS ORDERED BY THE ENGINEER.
5. THE ROOFING COLOR FOR EACH SPECIFIED BRIDGE IS SHOWN ON SHEET 4.
6. THE REQUIREMENTS FOR WHETHER OR NOT EACH BRIDGE CAN BE CLOSED TO TRAFFIC ARE DETAILED ON SHEET 4. BRIDGES THAT WILL BE CLOSED DURING CONSTRUCTION WORK MAY BE CLOSED TO ALL PEDESTRIAN AND VEHICULAR TRAFFIC. THE CONTRACTOR WILL PROVIDE THE TOWNS WRITTEN NOTICE A MINIMUM OF 3 WEEKS PRIOR TO THE ANTICIPATED BRIDGE CLOSURE AND START OF WORK. THE CONTACT INFORMATION FOR EACH TOWN AND OTHER PERTINENT INFORMATION ARE PROVIDED ON SHEET 4.
7. ALL WORK IS TO BE COMPLETED WITHIN THE AVAILABLE TOWN-OWNED RIGHT-OF-WAY AS DETAILED ON SHEET 4. THE R.O.W IS ASSUMED TO BE CENTERED ABOUT THE CENTER LINE OF THE BRIDGE. NO PROVISIONS HAVE BEEN MADE TO GO OUTSIDE THE EXISTING RIGHT-OF-WAY. SHOULD THE CONTRACTOR REQUIRE ANY ADDITIONAL R.O.W. IT WILL BE THE RESPONSIBILITY OF THE CONTRACTOR TO OBTAIN ALL EASEMENTS.
8. IT IS ANTICIPATED THAT NO WORK WILL TAKE PLACE WITHIN THE AFFECTED STREAMBEDS. SHOULD THE CONTRACTORS REQUIRE ANY WORK IN THE STREAM, SUCH AS RECTING STAGING, IT WILL BE THE RESPONSIBILITY OF THE CONTRACTOR TO OBTAIN ALL PERMITS.
9. GREAT CARE SHALL BE TAKEN BY THE CONTRACTOR TO PREVENT ANY MATERIAL FROM ENTERING THE AFFECTED STREAMBEDS PER SECTION 105 OF THE STANDARD SPECIFICATIONS FOR CONSTRUCTION. ANY MATERIAL THAT DOES ESCAPE THE CONTRACTORS CONTAINMENT SYSTEM WILL BE RECOVERED IMMEDIATELY.
10. IT IS NOT ANTICIPATED THAT ANY UTILITIES WILL REQUIRE ADJUSTMENT. THE CONTRACTOR IS CAUTIONED TO PROTECT THESE FACILITIES FROM DAMAGE. ALL DAMAGE TO UTILITIES AS RESULT OF THE CONTRACTORS OPERATIONS WILL BE REPAIRED AT NO COST TO THE STATE. SHOULD THE CONTRACTOR DESIRE UTILITY RELOCATIONS FOR THEIR OWN BENEFIT, ALL COSTS WILL BE THE CONTRACTORS RESPONSIBILITY.
11. ALL WORK SHALL PROCEED IN A CAREFUL, ORDERLY MANNER SO THAT AFFECTED HISTORIC STRUCTURES ARE NOT DAMAGED IN ANY WAY. THE CONTRACTOR IS RESPONSIBLE FOR REPAIRING ALL DAMAGE TO THE STRUCTURE AS A RESULT OF THEIR OPERATIONS AT NO COST TO THE STATE. ALL DAMAGE WILL BE REPORTED TO THE PROJECT MANAGER IMMEDIATELY AND NO REPAIRS WILL BE MADE UNTIL APPROVED BY THE STATE.
12. ALL TRAFFIC CONTROL DEVICES, INCLUDING BUT NOT LIMITED TO SIGNS, BARRELS, BARRICADES, CONES, BARRIERS, NECESSARY FOR MAINTENANCE OF TRAFFIC DURING CONSTRUCTION WILL BE PAID UNDER ITEM 641.10 TRAFFIC CONTROL AS DETAILED IN STANDARDS 107 AND 107A. WHILE DETOURS AS DETAILED IN STANDARD 107 WILL NOT BE ENCOUNTERED, GENERAL PLACEMENT OF APPROACH SIGNING AND "ROAD CLOSED" SIGNS WILL BE AS SHOWN ON STANDARD 107. AS CONDITIONS AT EACH SITE VARY, THE CONTRACTOR MAY CHOOSE TO SUBMIT INDIVIDUAL TRAFFIC CONTROL PLANS FOR REVIEW.
13. ALL REMOVED MATERIAL WILL BECOME PROPERTY OF CONTRACTOR.
14. ALL WORK SHALL BE DONE BRIDGE BY BRIDGE. ONCE A BRIDGE IS CLOSED, ALL WORK WILL BE DONE CONTINUOUSLY, WITH THE INTENT ON MINIMIZING HOW LONG A BRIDGE IS CLOSED TO TRAFFIC AND UNDER CONSTRUCTION. THIS MEANS THE REMOVAL OF ROOF, REPAIR OF SHEATHING AND PLACEMENT OF THE NEW ROOF WILL PROGRESS ON A CONTINUOUS BASIS. ONCE THE CONTRACTOR STARTS ON A BRIDGE, THE CONTRACTOR IS REQUIRED TO CONTINUE WORKING (A MINIMUM OF 5, EIGHT HOUR DAYS PER WEEK) ON EACH BRIDGE UNTIL THE WORK IS COMPLETED. THE BRIDGE WILL BE PROTECTED AGAINST THE ELEMENTS AT ALL TIME. ONCE THE ROOF REMOVAL BEGINS, THE CONTRACTOR WILL KEEP THE ROOF COVERED WITH WATERPROOF TARPES UNTIL SUCH TIME AS THE NEW ROOF IS INSTALLED. PAYMENT FOR THE PROTECTIVE COVERING IS INCLUDED IN THE ITEM665.18 METAL ROOFING.
15. THE INTENT OF THE PROJECT IS TO REPLACE DEFICIENT ROOFS. THIS WORK SHOULD BE ACCOMPLISHED WITHOUT HAVING TO PERFORM STRUCTURAL REPAIRS TO THE ROOF SYSTEM. IN THE EVENT THAT THE CONTRACTOR ENCOUNTERS A ROOF RAFTER OR OTHER ELEMENT THAT MUST BE REPLACED, THE ITEM 522.20 STRUCTURAL LUMBER TIMBER - UNTREATED WILL BE USED. SPECIES TO BE EASTERN SPRUCE, GRADE 1 OR BETTER A NOMINAL QUANTITY HAS BEEN SUPPLIED AS AN ESTIMATE ONLY. THIS WORK REQUIRES APPROVAL FROM THE PROJECT MANAGER PRIOR TO ITS USE.

PROJECT NAME:	STATEWIDE- NORTH REGION		
PROJECT NUMBER:	BHO HBRP(9)		
FILE NAME:	e\280note-09.xls	PLOT DATE:	2/28/02
PROJECT LEADER:	SUE SCRIBNER	DRAWN BY:	R. PELLETT
DESIGNED BY:	M. GAGULIC	CHECKED BY:	M. GAGULIC
GENERAL NOTES SHEET #1		SHEET	3 OF 8

PROJECT INFORMATION

	TOWN	COUNTY	BRIDGE NAME	BRIDGE NUMBER	ROUTE NUMBER	BRIDGE LENGTH	ESTIMATED ROOF AREA	AVAILABLE ROW	COLOR OF NEW ROOF	CAN BRIDGE BE CLOSED DURING CONSTR. WORK *	MUNICIPAL CONTACT FOR NOTIFICATION
1.	MONTGOMERY	FRANKLIN	WEST HILL (CREAMERY) COVERED BRIDGE	CB 32	TH 25	61'	1720 SQ.FT.	3 ROD	GREEN	YES	LINDA CLUBA, TOWN CLERK PO BOX 356 MONTGOMERY CENTER, VT 05471 TEL: (802) 326 - 4719
2.	MONTGOMERY	FRANKLIN	HUTCHINS COVERED BRIDGE	CB 34	TH 27	78'	2170 SQ.FT.	3 ROD	GREEN	YES, CANNOT BE CLOSED IF PROPERTY OWNERS PRESENT	LINDA CLUBA, TOWN CLERK PO BOX 356 MONTGOMERY CENTER, VT 05471 TEL: (802) 326 - 4719
3.	TROY	ORLEANS	RIVER ROAD COVERED BRIDGE	CB 8	TH 12	95'	2990 SQ.FT.	50 FEET	RUST 1# SILVER 2#	YES	ROLAND MAYHEW, CHAIRMAN 1127 COOP RD, NORTH TROY, VT 05859 TEL: (802) 744 - 6829
4.	WATERVILLE	LAMOILLE	VILLAGE COVERED BRIDGE	CB 14	TH 20	61'	1500 SQ.FT.	3 ROD	GREEN	YES, IF COULD BE DONE AFTER SCHOOL IS OUT	LEONARD LOCKE, CHAIR PO BOX 85, WATERVILLE, VT 05492 TEL: (802) 644 - 2946
5.	WATERVILLE	LAMOILLE	JAYNES COVERED BRIDGE	CB 15	TH 3	59'	1430 SQ.FT.	3 ROD	GREEN	YES, IF COULD BE DONE AFTER SCHOOL IS OUT	LEONARD LOCKE, CHAIR PO BOX 85, WATERVILLE, VT 05492 TEL: (802) 644 - 2946
6.	JOHNSON	LAMOILLE	SCRIBNER (MUDGET) COVERED BRIDGE	CB 30	TH 33	50'	1210 SQ.FT.	3 ROD	GREEN	YES	WILLIE JEWETTE, ROAD FOREMAN TEL: (802) 635 - 2611
7.	MORRISTOWN	LAMOILLE	RED COVERED BRIDGE	CB 39	TH 50	69'	2010 SQ.FT.	3 ROD	RED	YES, IF COULD BE DONE AFTER SCHOOL IS OUT	PAUL D. MCGINLEY, TOWN ADMINISTRATOR PO BOX 748 MORRISVILLE, VT 05661 TEL: (802) 888 - 5147
8.	LYNDON	CALEDONIA	CHAMBERLIN MILL COVERED BRIDGE	CB 33	TH 58	69'	2190 SQ.FT.	25 FEET	SILVER	YES	CRAIG KLEMAN, MUNICIPAL ASSISTANT PO BOX 167 LYNDONVILLE, VT 05851 TEL: (802) 626 - 5834
9.	BELVIDERE	LAMOILLE	MORGAN (UPPER) COVERED BRIDGE	CB 13	TH 2	71'	1700 SQ.FT.	3 ROD	GREEN	YES	HUGH TALLMAN, ROAD COMMISSIONER TEL: (802) 649 - 2571 PAGER: (802) 644 - 2751

* - SEE GENERAL NOTE 6

PROJECT NAME:	STATEWIDE - NORTH REGION
PROJECT NUMBER:	BHO HBRP (9)
FILE NAME:	/OIJ250/str/sj250Info.dgn
PROJECT LEADER:	SUE SCRIBNER
DESIGNED BY:	M. GAGULIC
sj250Info-09.1	
PLOT DATE:	28-FEB-2002
DRAWN BY:	M. GAGULIC
CHECKED BY:	M. GAGULIC
SHEET 4	OF 5

STATE OF VERMONT
AGENCY OF TRANSPORTATION

QUANTITY SHEET

SUMMARY OF ESTIMATED QUANTITIES											TOTALS			DESCRIPTIONS			DETAILED SUMMARY OF QUANTITIES		
LOCATION NO. 1	LOCATION NO. 2	LOCATION NO. 3	LOCATION NO. 4	LOCATION NO. 5	LOCATION NO. 6	LOCATION NO. 7	LOCATION NO. 8	LOCATION NO. 9	BRIDGE QUANTITY	ROUND	GRAND TOTAL	FINAL	UNIT	ITEMS	ITEM NUMBER	QUANTITIES	UNIT	ITEMS	
0.02	0.02	0.03	0.02	0.01	0.01	0.02	0.02	0.02	0.17	EST.	0.17		MFBM	STRUCTURAL LUMBER AND TIMBER - UNTREATED	522.20				
0.43	2.17	0.30	0.15	0.14	0.91	0.50	0.11	0.34	5.05	EST.	5.05		MFBM	NON - STRUCTURAL LUMBER-UNTREATED	522.30				
0.10	0.13	0.18	0.08	0.09	0.07	0.12	0.13	0.10	1.00		1.00		LS	MOBILIZATION	635.10				
1									1		1		LS	TRAFFIC CONTROL (MONTGOMERY, CB 32, LOCATION NO. 1)	641.10				
	1								1		1		LS	TRAFFIC CONTROL (MONTGOMERY, CB 34, LOCATION NO. 2)	641.10				
		1							1		1		LS	TRAFFIC CONTROL (TROY, CB 8, LOCATION NO. 3)	641.10				
			1						1		1		LS	TRAFFIC CONTROL (WATERVILLE, CB 14, LOCATION NO. 4)	641.10				
				1					1		1		LS	TRAFFIC CONTROL (WATERVILLE, CB 15, LOCATION NO. 5)	641.10				
					1				1		1		LS	TRAFFIC CONTROL (JOHNSON, CB 30, LOCATION NO. 6)	641.10				
						1			1		1		LS	TRAFFIC CONTROL (MORRISTOWN, CB 39, LOCATION NO. 7)	641.10				
							1		1		1		LS	TRAFFIC CONTROL (LYNDON, CB 33, LOCATION NO. 8)	641.10				
								1	1		1		LS	TRAFFIC CONTROL (BELVIDERE, CB 13, LOCATION NO. 9)	641.10				
1720	2170	2990	1500	1430	1210	2010	2190	1700	16920		16920		SF	REMOVING EXISTING ROOF	665.15				
1720	2170	2990	1500	1430	1210	2010	2190	1700	16920		16920		SF	METAL ROOFING	665.18				

PROJECT NAME: STATEWIDE - NORTH REGION
 PROJECT NUMBER: BHO HBRP(9)
 FILE NAME: e250qy-09.xls
 PROJECT LEADER: SUE SCRIBNER
 DESIGNED BY: M. GAGULIC
 QUANTITY SHEET #1
 PLOT DATE: 2/28/02
 DRAWN BY: R. PELLETT
 CHECKED BY: M. GAGULIC
 SHEET 5 OF 5

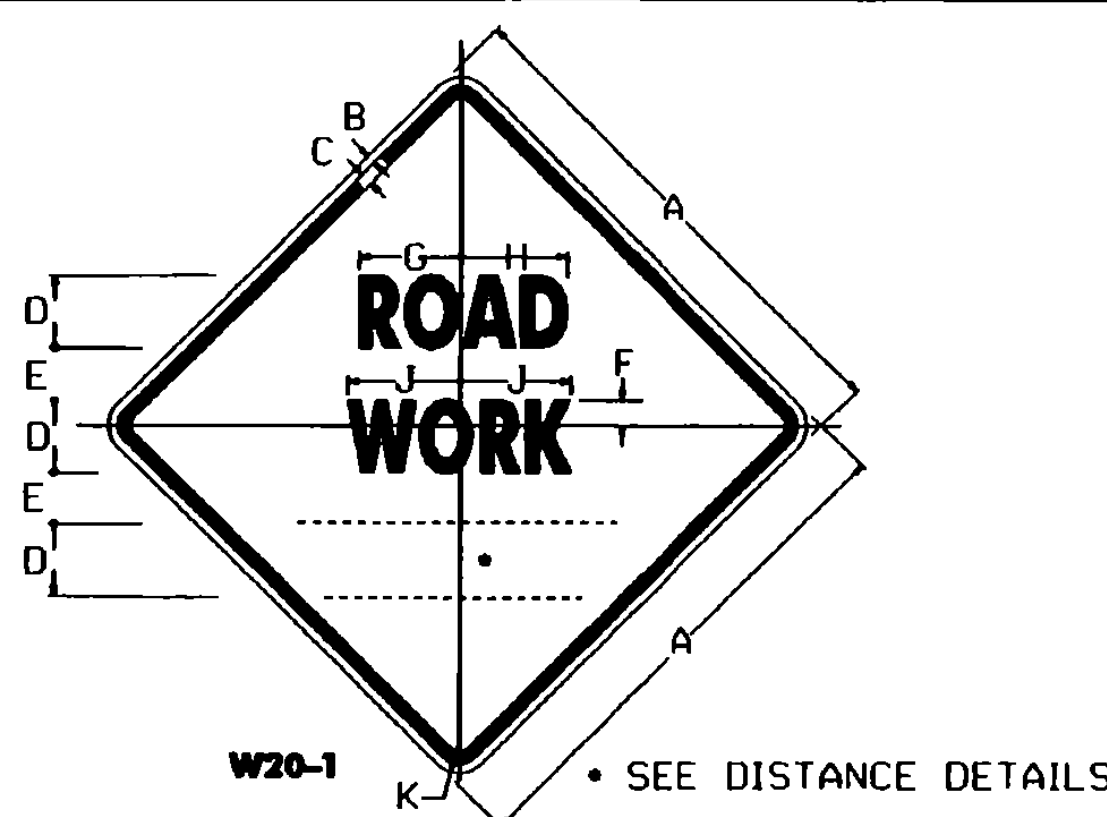

W20-1
• SEE DISTANCE DETAILS
COLORS
TEXT AND BORDER - BLACK (NON-REFL.)
BACKGROUND - ORANGE (REFL.)

SIGN	DIMENSIONS (INCHES)										
	A	B	C	D	E	F	G	H	J	K	
MIN.	30	1/2	3/4	40	2 1/2	2 1/2	6 3/4	7	7 3/4	1 3/8	
STD.	36	5/8	7/8	50	3 1/2	3 1/2	8 1/8	8 1/2	9	2 1/4	
SPECIAL	48	1	1 1/4	70	4 1/2	4 1/2	11 1/4	12 1/8	12 1/2	3	

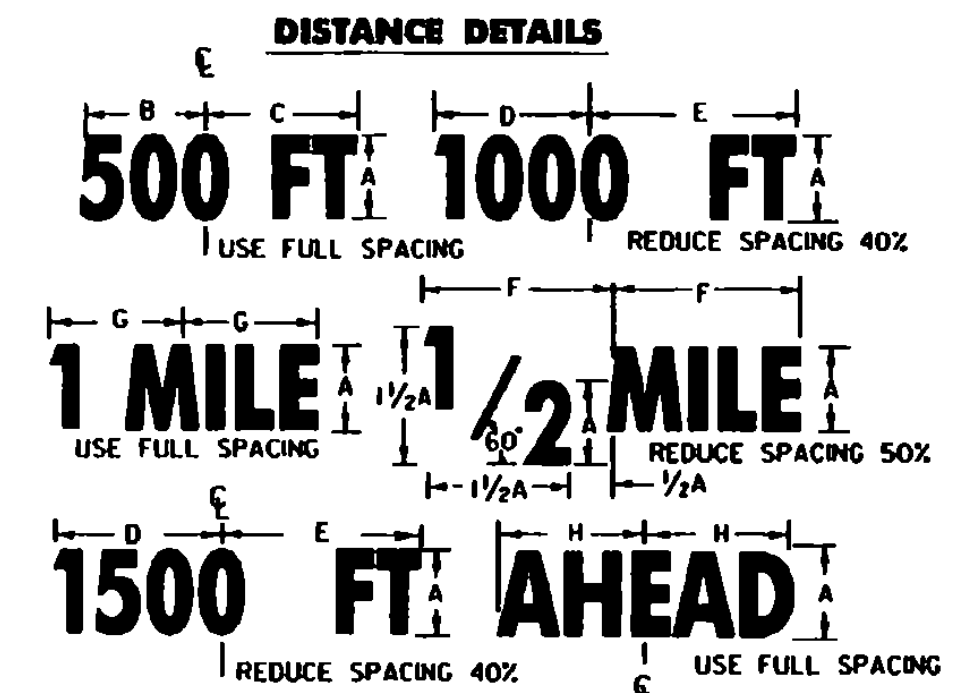

DIMENSIONS (INCHES)							
A	B	C	D	E	F	G	H
4D	8 1/8	8 3/8	8 1/2	9	9	7 3/8	8 1/4
5D	10 3/8	10 3/8	9 3/8	11 1/4	11 1/4	9 1/2	10 3/8
7D	14 1/4	15 1/8	14 1/8	15 3/4	15 3/4	13 1/8	15 1/2

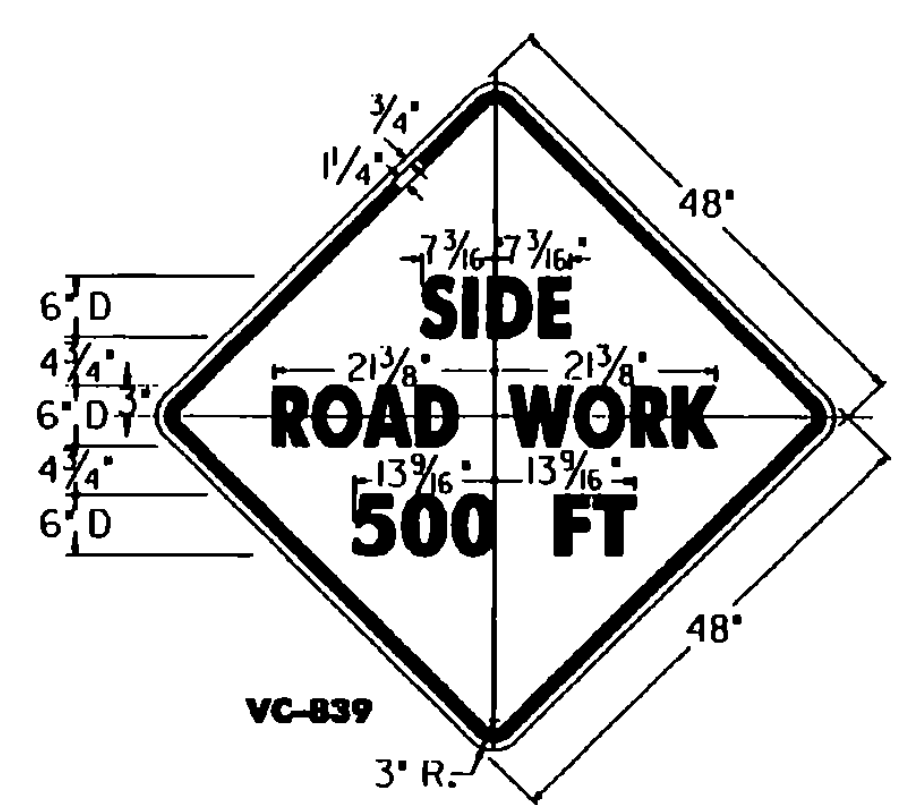

VC-839
OR LEFT - 17 3/4"
RIGHT - 22"
500 FT - 14 3/4"
FT - 8 1/8"

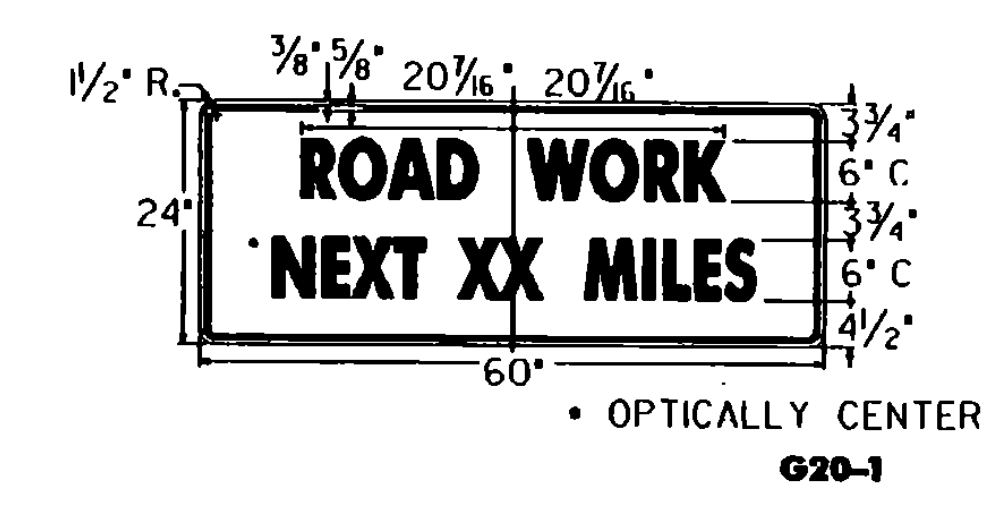

G20-1
• OPTICALLY CENTER
THIS SIGN TO BE USED WHEN PROJECT LENGTH EXCEEDS 2 MILES OR AS REQUESTED BY THE RESIDENT ENGINEER. SHOW MILEAGE TO NEAREST 1/4 MILE USING FRACTIONS, NOT DECIMALS. HAND LETTERING OF MILEAGE WILL NOT BE ALLOWED.

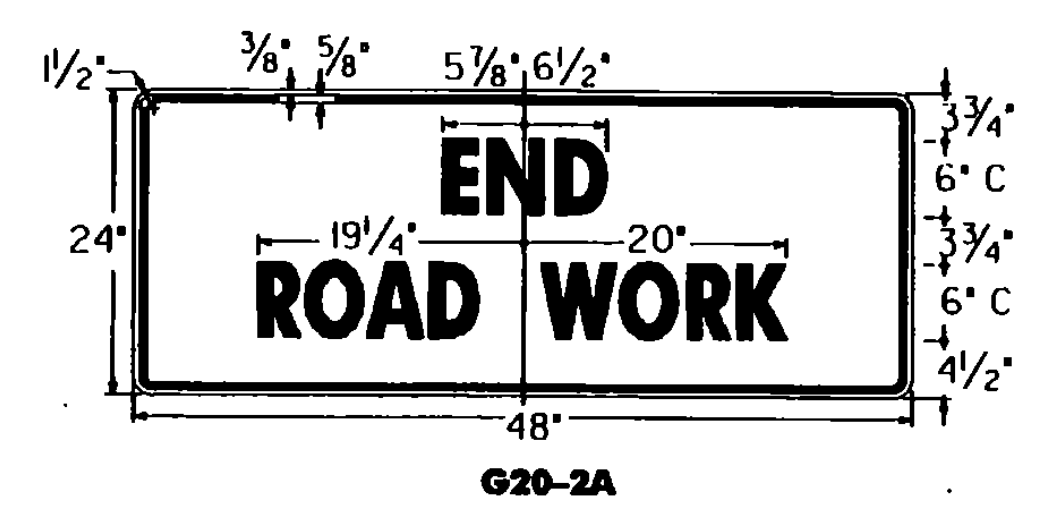

NOTES

THE SIGNS SHOWN ON THIS SHEET ARE INTENDED FOR USE IN PROVIDING ADVANCE WARNING AND INFORMATION ON CONSTRUCTION PROJECTS OVER WHICH TRAFFIC WILL BE MAINTAINED. WHEN ADDITIONAL APPROACH SIGNS OR OTHER TYPES OF ADVANCE SIGNING OR CONTROL ARE NECESSARY, THE PLANS AND/OR THE SPECIFICATIONS FOR THAT PROJECT WILL GIVE THE DETAILS OF THE SIGNS AND DEVICES REQUIRED. FOR ON-PROJECT CONSTRUCTION SIGNS, REFER TO APPROPRIATE STANDARD SHEETS.

APPLICATION OF STANDARDS
SINCE IT IS NOT POSSIBLE TO PRESCRIBE DETAILED STANDARDS OF APPLICATION FOR ALL OF THE SITUATIONS THAT MAY CONCEIVABLY ARISE ON A CONSTRUCTION PROJECT, REFERENCE SHALL BE MADE TO THE "MANUAL ON UNIFORM TRAFFIC CONTROL DEVICES" FOR THE PRINCIPLES, PROCEDURES, AND STANDARDS THAT WILL BE REQUIRED IN CONNECTION WITH ADVANCED WARNING AND ON-PROJECT CONSTRUCTION SIGNS AND BARRIAGES. THE SIGNS SHOWN IN E-101 AND E-102 REPRESENT A SAMPLE OF THOSE MORE COMMONLY USED.

LOCATION
THE SIGNS SHALL BE LOCATED AS DETAILED ON THIS SHEET OR AS OTHERWISE SHOWN ON THE PLANS. THEY SHALL APPEAR AT EACH END OF THE HIGHWAY UNDER CONSTRUCTION AND ON ALL INTERSECTING PUBLIC HIGHWAYS. THE EXACT PLACEMENT OF ANY SIGN WILL DEPEND UPON THE ALIGNMENT INTENDED TO INDICATE THE SEQUENCE TO BE FOLLOWED, AND THE APPROXIMATE SPACING TO BE OBSERVED, THE ENGINEER SHALL DETERMINE THE EXACT LOCATIONS.

DESIGN
LETTERS, DIGITS, ARROWS SPACING AND TEXT DIMENSIONS SHALL CONFORM WITH THE "STANDARD ALPHABET FOR HIGHWAY SIGNS AND PAVEMENT MARKINGS" AND DESIGNS PRESCRIBED IN THE STANDARD HIGHWAY SIGNS AS SPECIFIED IN THE MANUAL ON UNIFORM TRAFFIC CONTROL DEVICES ADOPTED BY THE U.S. DEPARTMENT OF TRANSPORTATION, FEDERAL HIGHWAY ADMIN.

MATERIALS
THE SIGN BASE MATERIAL USED FOR THE SIGNS ON THIS SHEET MAY BE ANY OF THE FOLLOWING, WITH MINIMUM THICKNESS AS NOTED.
FLAT SHEET ALUMINUM 0.125 INCHES
HIGH DENSITY OVERLAPPED PLYWOOD 5/8 INCHES
GALVANIZED SHEET STEEL 12 GAGE

REFLECTORIZATION
ALL REFLECTORIZED MATERIAL SHALL CONSIST OF TYPE 11B OR TYPE 111 SHEETING.

COLORS
THE COLORS SHALL CONFORM WITH THE STANDARD COLORS ADOPTED BY THE AMERICAN ASSOCIATION OF STATE HIGHWAY AND TRANSPORTATION OFFICIALS AND APPROVED BY THE U.S. DEPARTMENT OF TRANSPORTATION, FEDERAL HIGHWAY ADMINISTRATION. COLORS SHOWN ON THIS SHEET CONSIST OF BLACK TEXT AND BORDER ON A REFLECTORIZED ORANGE BACKGROUND.

INSTALLATION
THE SIGNS SHALL BE ERECTED BEFORE THE START OF ANY WORK AND SHALL BE COVERED UNTIL WORK COMMENCES. DURING PERIODS OF INACTIVITY, OR UPON COMPLETION OF THE WORK, SIGNS MAY BE REMOVED UPON COMPLETION OF THE WORK AT THE DISCRETION OF THE ENGINEER. EACH SIGN SHALL BE ERECTED IN A NEAT AND WORKMANLIKE MANNER ON POSTS SET SECURELY IN THE GROUND. THE BOTTOM OF A SIGN SHALL BE AT LEAST 7 FEET ABOVE THE EDGE OF PAVEMENT, AND THE NEAREST EDGE OF A SIGN SHALL BE AT LEAST 6 FEET OUTSIDE THE SHOULDER POINT, 4 FEET OUTSIDE GUARD RAIL, OR 2 FEET OUTSIDE CURBING OR SIDEWALK. THE INSTALLATION OF SIGNS SHALL BE SUBJECT TO APPROVAL OF THE ENGINEER. IN URBAN AREAS, THE BOTTOM OF THE SIGN SHALL BE AT LEAST 7 FEET ABOVE THE SIDEWALK.

MAINTENANCE
SIGNS SHALL BE MAINTAINED IN A CLEAN AND LEGIBLE CONDITION SATISFACTORY TO THE ENGINEER. THEY SHALL BE COMPLETELY VISIBLE TO APPROACHING TRAFFIC AT ALL TIMES. THEY SHALL BE KEPT PLUMB AND LEVEL AND ALWAYS PRESENT A NEAT APPEARANCE. DAMAGED, DEFACED, OR DIRTY SIGNS SHALL BE REPAIRED, CLEANED OR REPLACED AS ORDERED BY THE ENGINEER.

GENERAL
THE COST OF FURNISHING, INSTALLING, MAINTAINING AND REMOVING ALL CONSTRUCTION APPROACH SIGNS WILL BE CONSIDERED SUBSIDIARY WORK PERTAINING TO THE PROJECT MATERIAL SATISFACTORY TO THE ENGINEER. NO MATERIAL WILL BE APPROVED THAT WILL DEGRADATE BY EXPOSURE TO THE WEATHER DURING THE PROJECT. MOUNTING OF THE PANEL SHALL BE DONE IN SUCH A WAY AS NOT TO DAMAGE THE SIGN FACE MATERIAL.

CONTRACTORS
CONTRACTORS SHALL COORDINATE THEIR SIGNING ACTIVITIES WITH OTHER CONTRACTORS WITHIN THE PROJECT LIMITS, AS DIRECTED BY THE REGIONAL CONSTRUCTION ENGINEER.

SIGN POSTS
WHERE CONSTRUCTION SIGN INSTALLATIONS ARE NOT PROTECTED BY GUARD RAIL OR OTHER APPROVED TRAFFIC BARRIERS, THE POSTS ON WHICH THE SIGNS ARE MOUNTED SHALL BE YIELDING METAL POSTS AS DESIGNATED IN THE E SERIES OF STANDARD DRAWINGS OR YIELDING WOODEN POSTS IN ACCORDANCE WITH THE FOLLOWING REQUIREMENTS:
WOODEN POSTS ARE ACCEPTABLE FOR USE WITH CONSTRUCTION SIGNS. THESE POSTS SHALL HAVE A UNIFORM CROSS-SECTION AND SHALL BE MADE FROM GRADE 2, AIR-DRIED SOUTHERN YELLOW PINE OR ANOTHER EQUIVALENT SOFTWOOD. AN ACCEPTABLE EQUIVALENT SOFTWOOD SHALL HAVE AN EXTREME FIBER TENSILE "Fv" DESIGN VALUE NOT TO EXCEED 1400 psi AND HORIZONTAL SHEAR "Fv" DESIGN VALUE NOT TO EXCEED 90 psi SPECIFICATION: "DESIGN VALUES FOR WOOD CONSTRUCTION" AND RELATED SUPPLEMENT, DATED 1986.
AS ESTABLISHED BY THE NATIONAL FOREST PRODUCTS ASSOCIATION IN THEIR NATIONAL DESIGN THE FOLLOWING ARE CONSIDERED TO BE ACCEPTABLE WOODEN POSTS:
1. 4" x 4" (ACTUAL DIMENSIONS ARE 3.5" x 3.5")
A) ACCEPTABLE FOR SINGLE OR DUAL POSTS INSTALLATION WITH NO MODIFICATIONS.
2. 4" x 6" (ACTUAL DIMENSIONS ARE 3.5" x 5.5")
A) ACCEPTABLE FOR SINGLE POST INSTALLATIONS ONLY WHEN MODIFIED BY DRILLING TWO 1 1/2" DIAMETER HOLES, ONE AT 4" AND THE OTHER 18" ABOVE THE GROUND LINE AND PERPENDICULAR TO THE ROADWAY CENTERLINE.
3. 6" x 6" (ACTUAL DIMENSIONS ARE 5.5" x 5.5")
A) ACCEPTABLE FOR SINGLE POST INSTALLATIONS ONLY WHEN MODIFIED BY DRILLING TWO 2" DIAMETER HOLES, ONE AT 4" AND THE OTHER AT 18" ABOVE THE GROUND LINE AND PERPENDICULAR TO ROADWAY CENTERLINE.
4. 6" x 8" (ACTUAL DIMENSIONS ARE 5.5" x 7.5")
A) ACCEPTABLE FOR SINGLE POST INSTALLATIONS ONLY WHEN MODIFIED BY DRILLING TWO 3" DIAMETER HOLES, ONE AT 4" AND THE OTHER AT 18" ABOVE THE GROUND LINE AND PERPENDICULAR TO THE ROADWAY CENTERLINE.

ADDITIONAL DESIGN CRITERIA
THE LONGER DIMENSION OF THE POST(S), SUCH AS THE 6" DIMENSION OF THE 4" x 6" POST, SHALL BE PLACED PARALLEL TO THE ROADWAY CENTERLINE. ALL WOODEN POSTS SHALL HAVE AN EMBEDMENT DEPTH OF 4 FEET. NO CROSS-BRACING OR BACK-BRACING TO KEEP THE POSTS PLUMB WILL BE ALLOWED. CONCRETE FOUNDATIONS COLLARS OR SOIL BEARING PLATES ARE NOT PERMITTED. CONSTRUCTION SIGNS SHALL BE PLACED ON TWO OR MORE POSTS WHEN ANY OF THE FOLLOWING CONDITIONS GOVERN:
A) THE SIGN WIDTH (HORIZONTAL DIMENSIONS FOR DIAMOND SHAPED SIGNS) EXCEEDS 3 1/2 FEET.
B) THE EXPOSED SIGN AREA OF ANY SINGLE SIGN OR ASSEMBLY EXCEEDS 12 1/2 SQ. FEET.
C) THE SV OF A SINGLE POST IS EXCEEDED. (SEE THE POST SELECTION CHART BELOW).

WOOD POST SELECTION CHART

SIGN AREA (FT ²) X HEIGHT (FT)	SV (SELECTION VALUE)	DESIGN CRITERIA:
4" x 4"	64	WIND SPEED = 60 MPH (10-YEAR MEAN OCCURRENCE INTERVAL)
4" x 6"	147	WIND PRESSURE = 13 psf
6" x 6"	216	ALLOWABLE BENDING STRESS
6" x 8"	389	

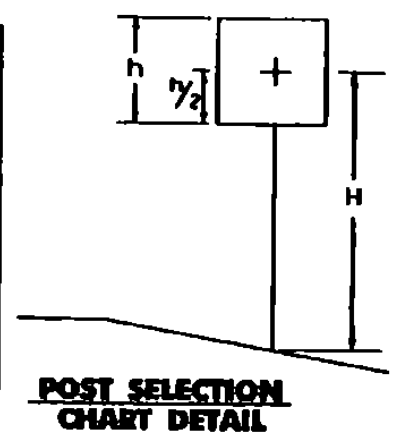

OTHER STDS. REQUIRED:

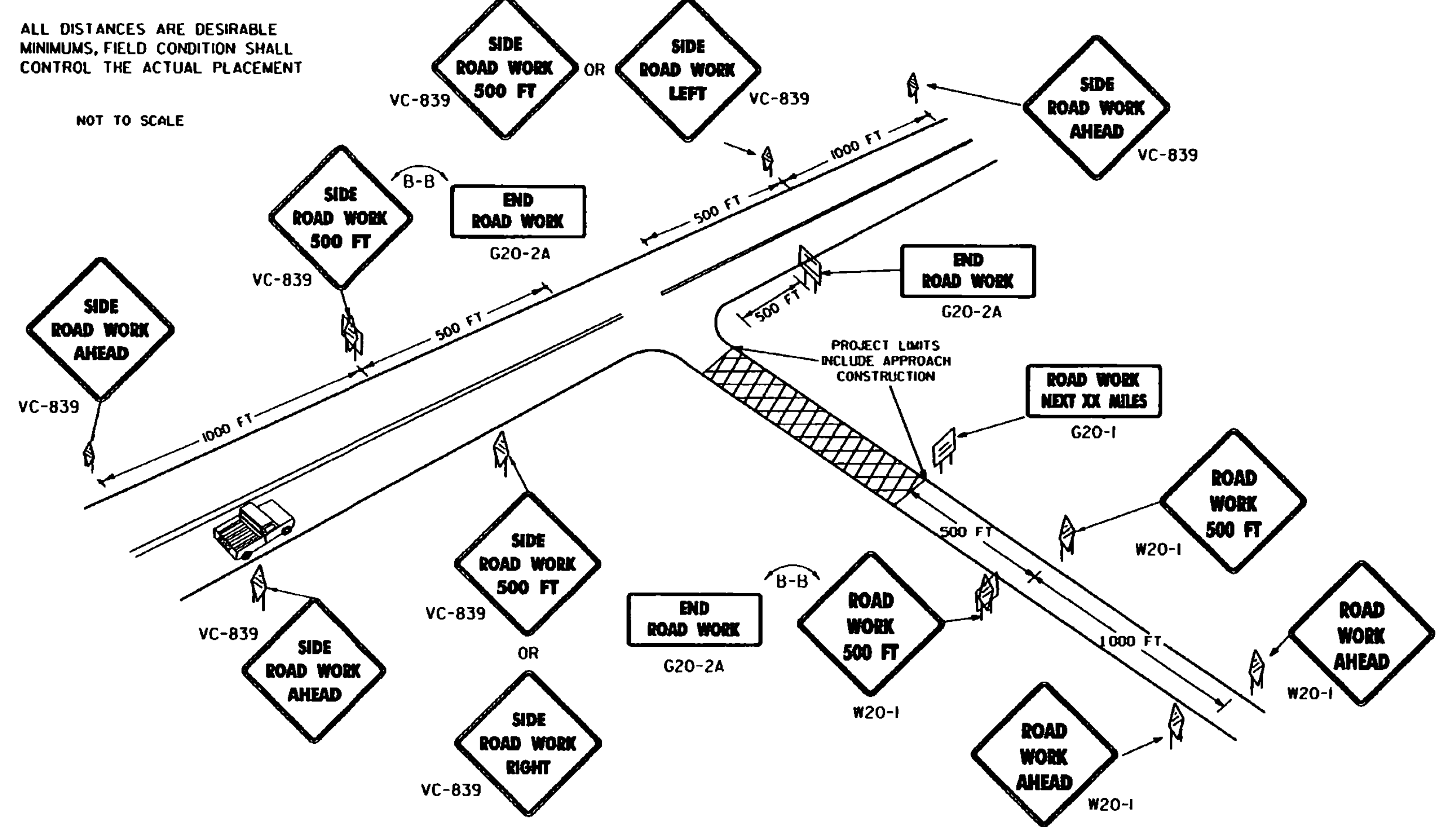

SIDE ROAD CONSTRUCTION APPROACH SIGNING (TO BE USED WHEN CONSTRUCTION IS UP TO 1000' FROM THE INTERSECTION)

REVISIONS AND CORRECTIONS
JAN. 06, 1997 - DATE OF ORIGINAL ISSUE

APPROVED
[Signature]
DIRECTOR OF ENGINEERING
[Signature]
DIRECTOR OF CONSTRUCTION AND MAINTENANCE

SIDE ROAD CONSTRUCTION APPROACH SIGNS

STANDARD E-100A

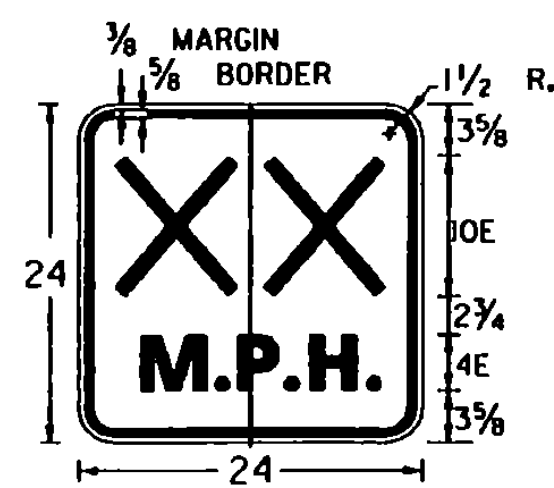

**XX* DENOTES ADVISORY SPEED AS SHOWN ON THE PLANS

W13-1

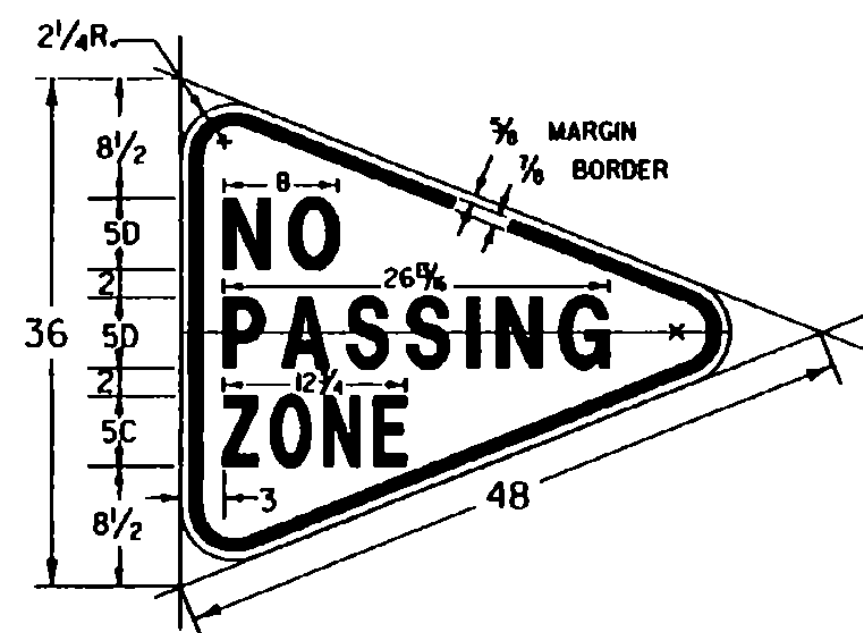

W14-3

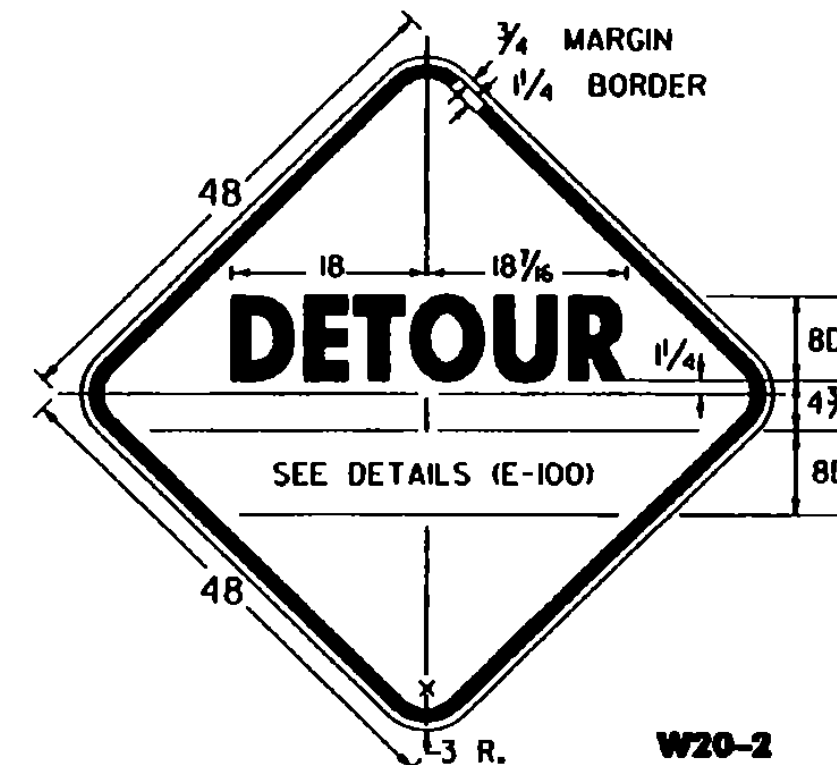

W20-2

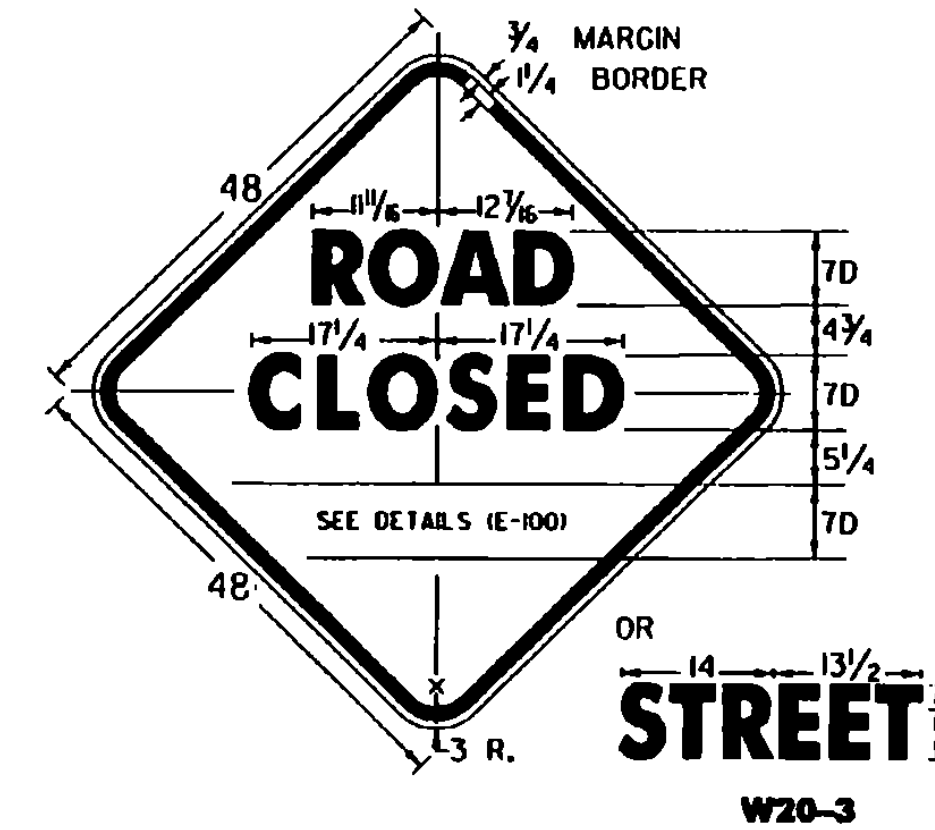

W20-3

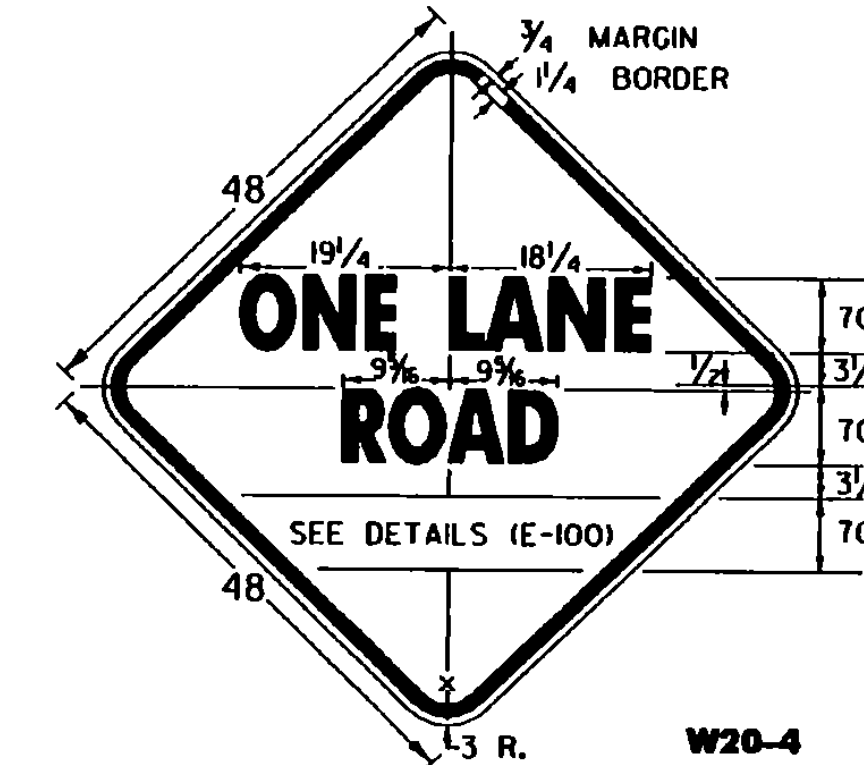

W20-4

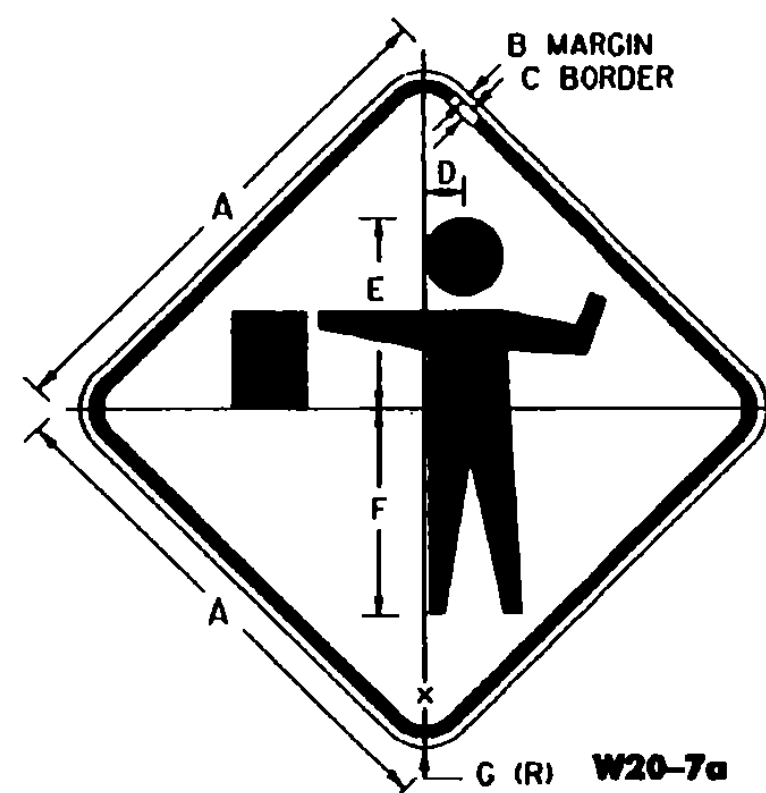

W20-7a

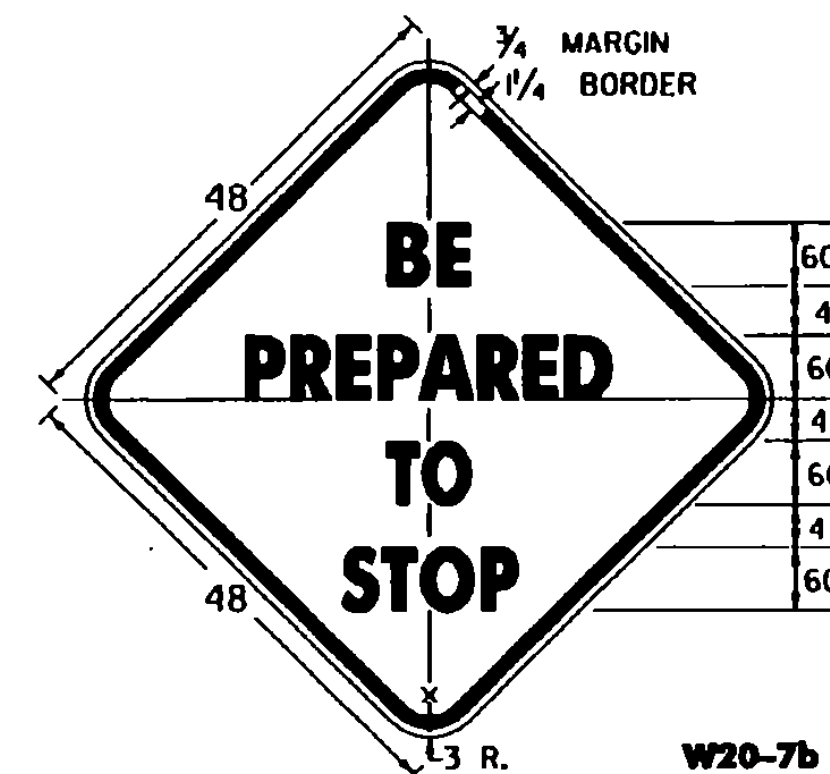

W20-7b

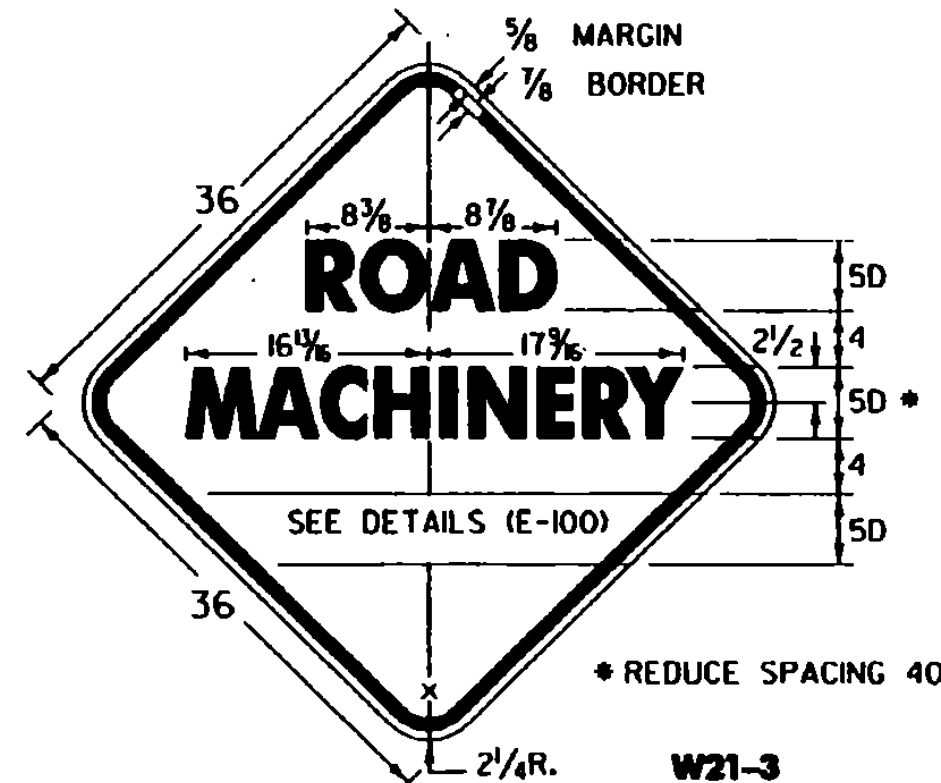

W21-3

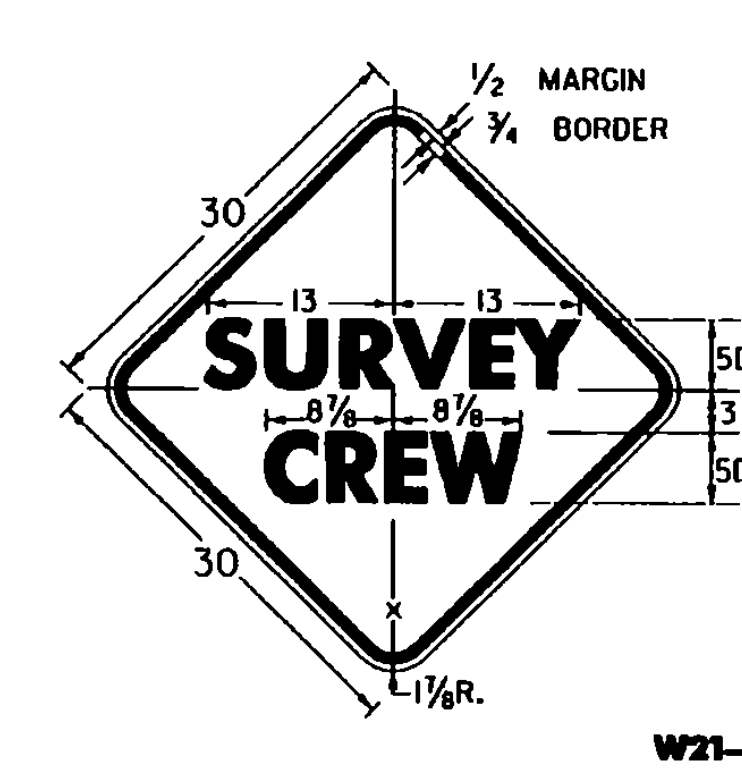

W21-6

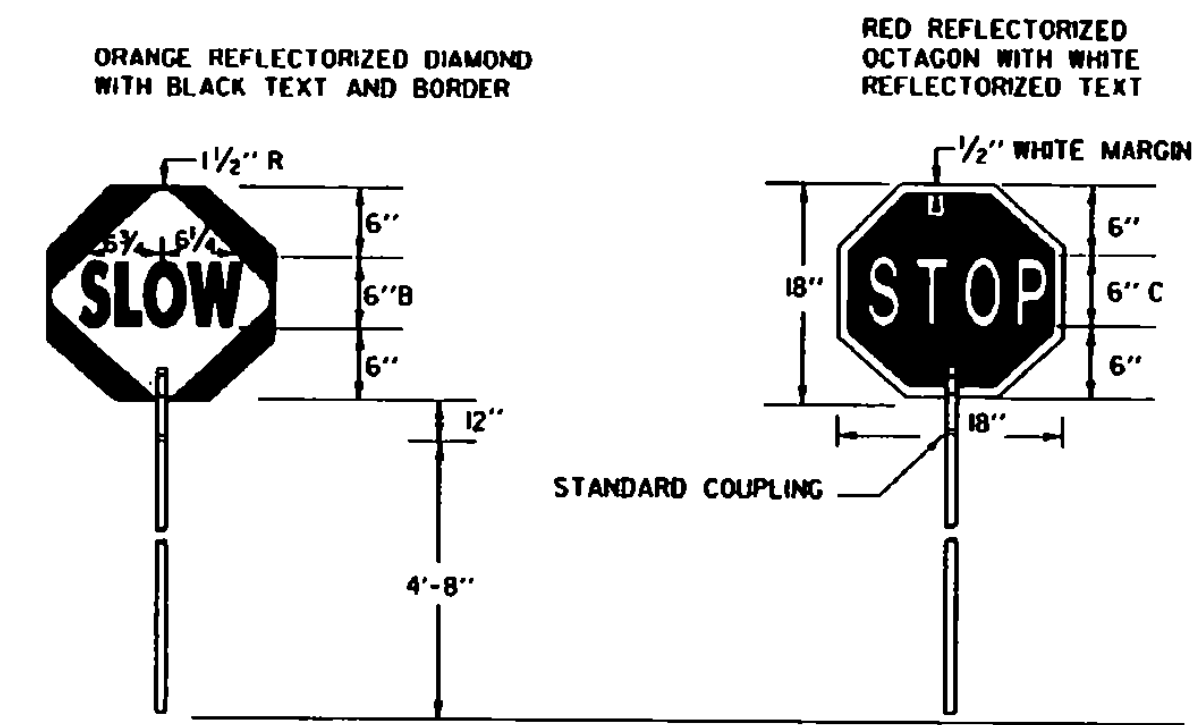

SIGN DETAIL

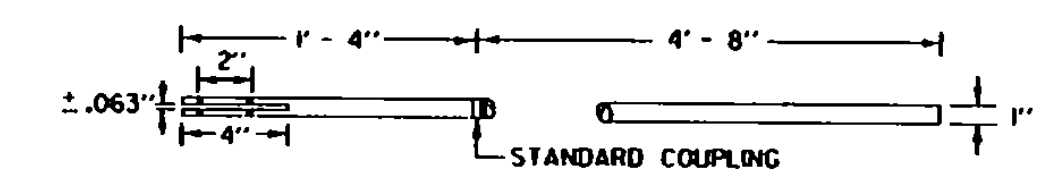

STAFF DETAIL

MATERIALS
THE SIGN MATERIALS SHALL BE 0.063" ALUMINUM WITH COLORS AS INDICATED ON DETAILS.
THE STAFF SHALL BE 1/2" TO 1/4" DIAMETER RIGID ALUMINUM CONDUIT/TUBING WITH A WALL THICKNESS OF 0.025" OR P TO 1/2" DIAMETER RIGID PVC CONDUIT/TUBING WITH 0.025" WALL THICKNESS.

MOUNTING
THE STAFF SHALL BE MOUNTED WITH EITHER TWO 1/4" DIAMETER ALUMINUM BOLTS OR TWO 1/4" DIAMETER ALUMINUM RIVETS.

SIGN PADDLE FOR FLAGPERSON

NOTES

SEE STANDARD SHEET E-100 FOR NOTES AND TEXT DETAILS. COLORS FOR SIGNS SHOWN ON THIS SHEET SHALL BE BLACK TEXT, BORDER AND SYMBOLS SHALL BE ON A REFLECTORIZED ORANGE BACKGROUND OF TYPE II B OR TYPE III REFLECTIVE SHEETING, UNLESS OTHERWISE NOTED. THE EXCEPTION IS THE PADDLE SIGN.

SIGN DETAILS INDICATE THE APPROPRIATE COLOR.

SIGNS USED ONLY FOR DAYTIME MAINTENANCE OPERATIONS DO NOT NEED TO BE REFLECTORIZED, HOWEVER, THESE SIGNS SHALL BE LABELED "DAYTIME USE ONLY" ON THE BACK OF THE SIGN PANEL WITH 3" SERIES C LETTERS.

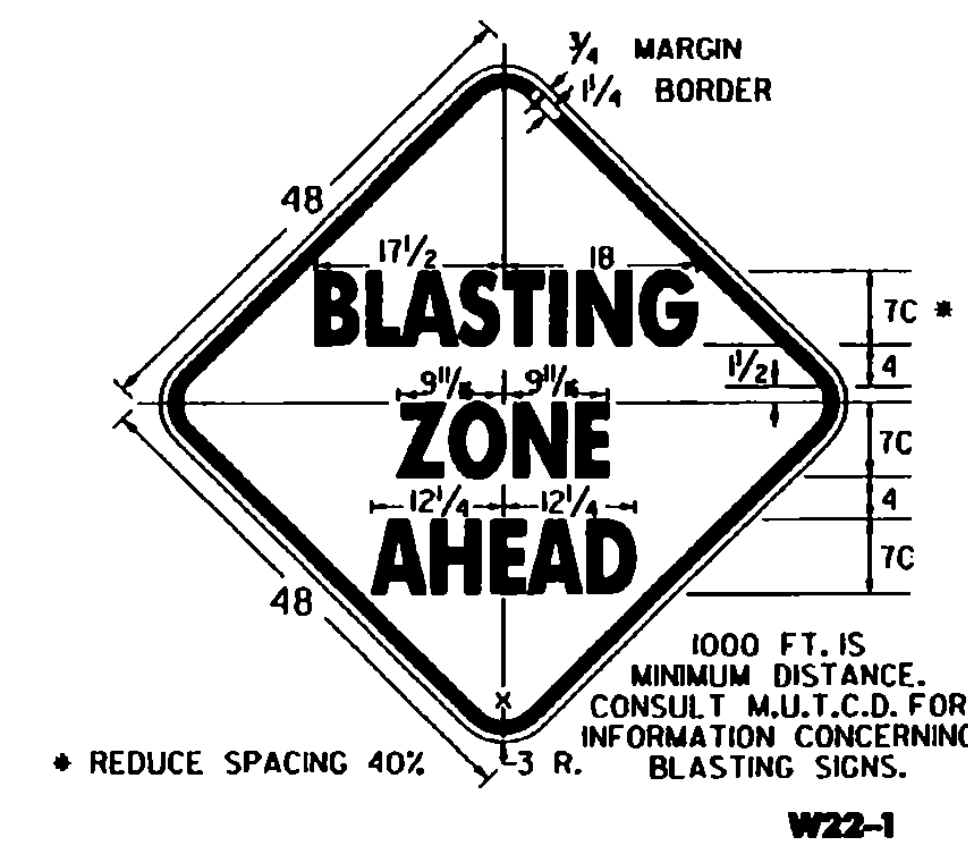
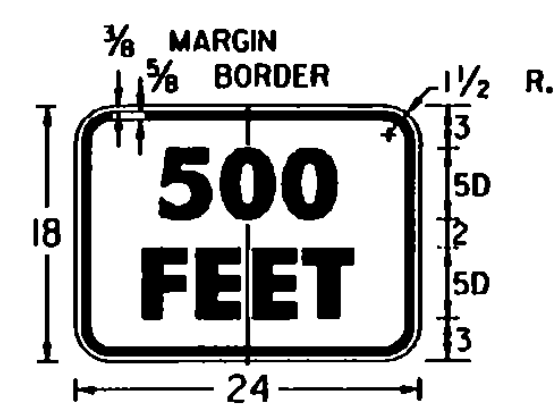
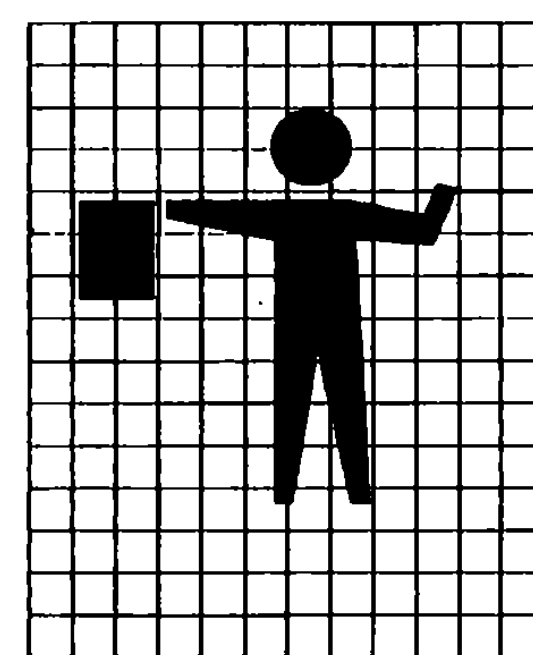

W22-1

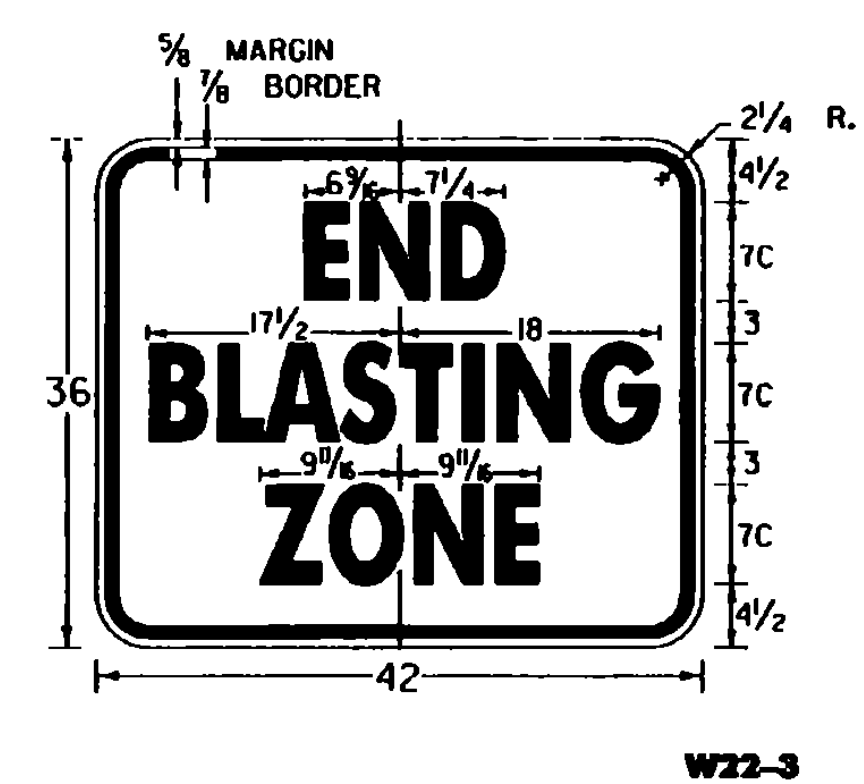

W22-3

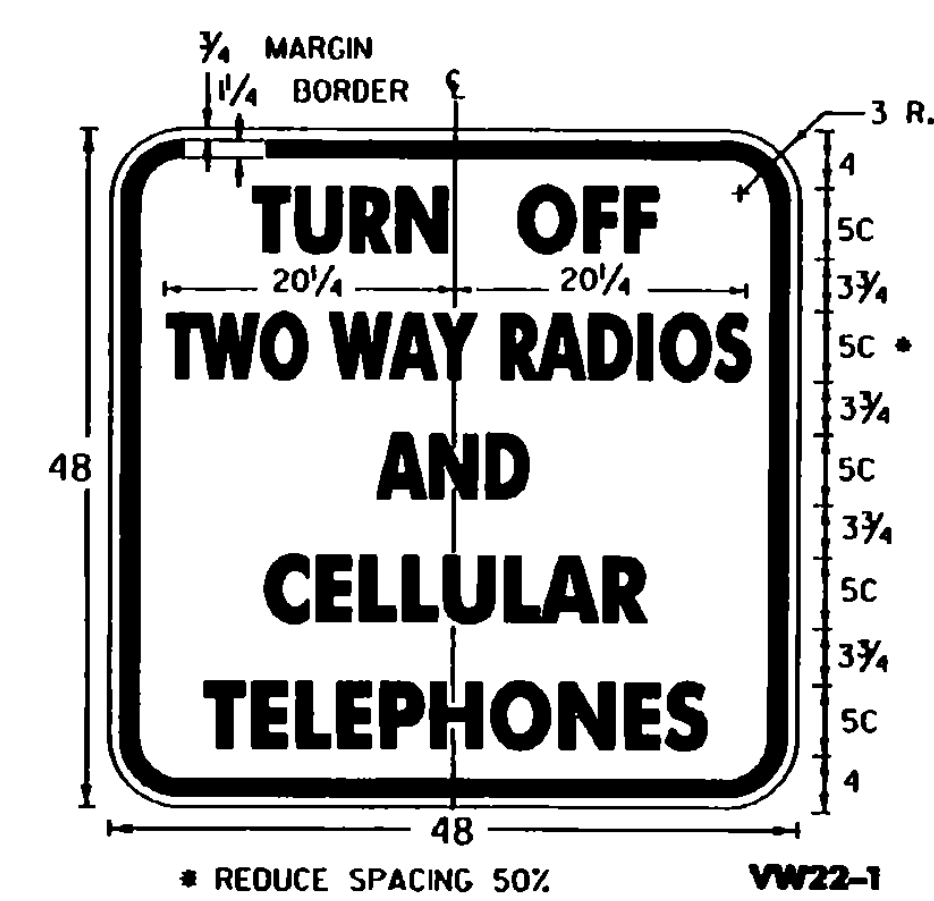

W22-1

DIMENSIONS (INCHES)							
SIGN	A	B	C	D	E	F	G
STD.	36	3/8	1/4	2 3/4	13 1/2	14 3/4	2 1/4
FWY.	48	3/4	1 1/4	3 3/4	18	19 1/2	3

(ALL DIMENSIONS SHOWN IN INCHES)

OTHER STDS. E-100 REQUIRED:

REVISIONS AND CORRECTIONS

OCT. 30, 1987 - DATE OF ORIGINAL ISSUE
 JAN. 23, 1989 - DELETE MOTORCYCLE SYMBOL SIGN AND SPEED SIGN, ADDED TWO SIGNS
 OCT. 21, 1992 - ADDED A SIGN, REVISED A SIGN DIMENSION & TYPE ERROR & REVISED TITLE BLOCK
 AUG. 08, 1995 - ADDED FLAGGER GRID

APPROVED

Stephen D. MacAllen
DIRECTOR OF ENGINEERING

David A. Reed
TRAFFIC AND SAFETY ENGINEER

CONSTRUCTION SIGN
DETAILS

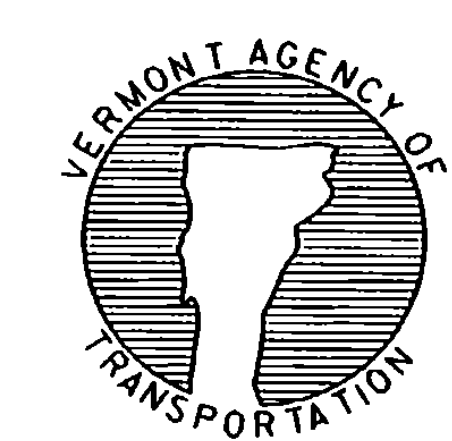

STANDARD
E-102

APPROVED FOR THIS PROJECT AND/OR DESIGN IMPLEMENTATION. FHWA FINAL APPROVAL PENDING.

/traf/std/stdel02.dgn : stdel02.1

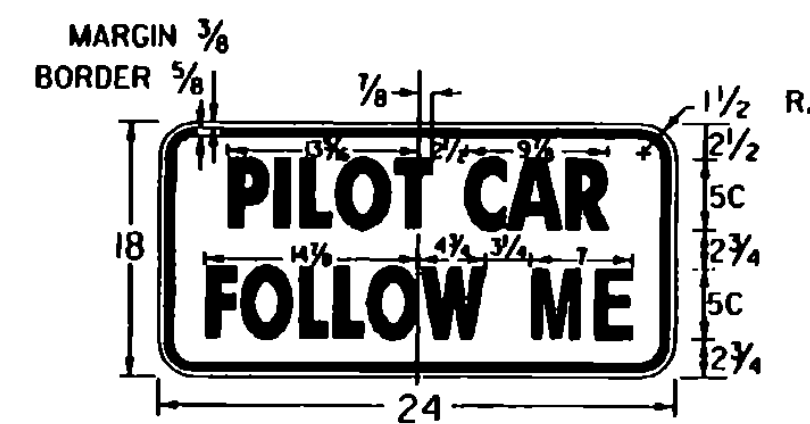

G20-4

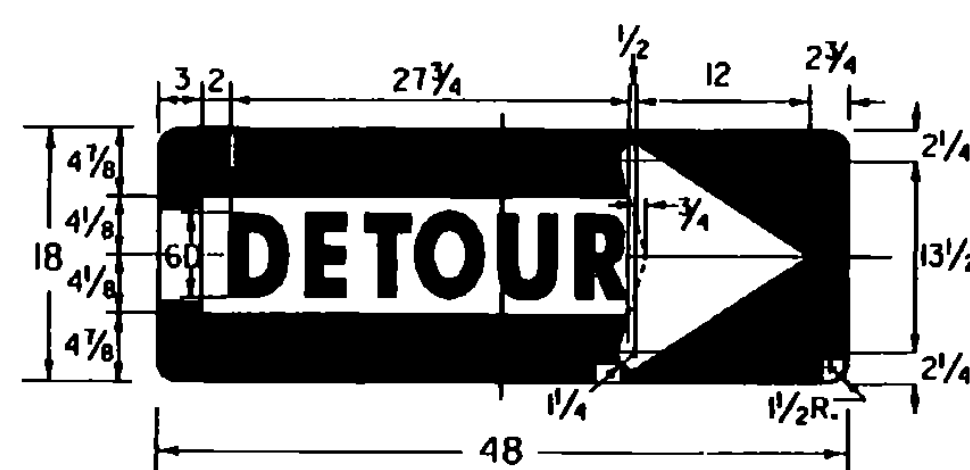

M4-10(R)

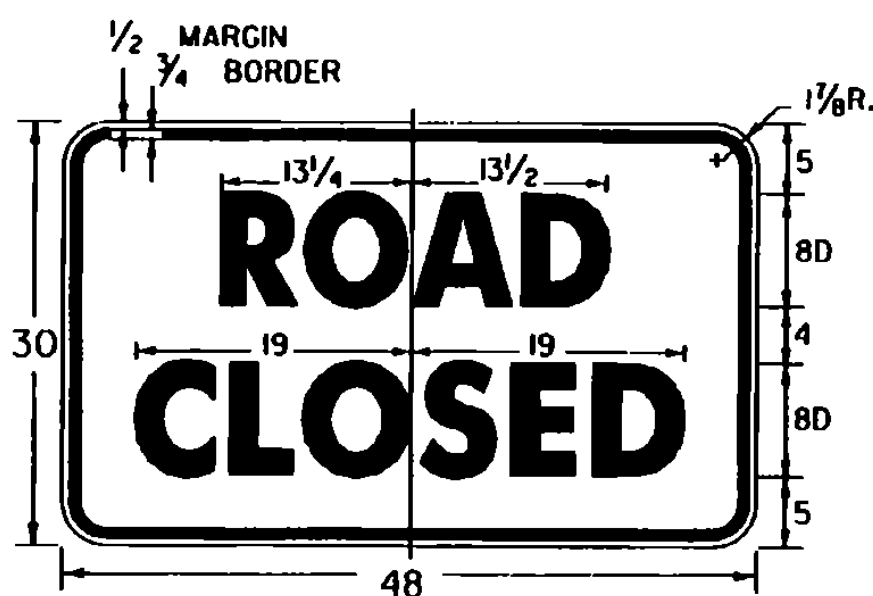

COLORS:
BLACK TEXT AND BORDER
WHITE REFLECTORIZED BACKGROUND

R11-2

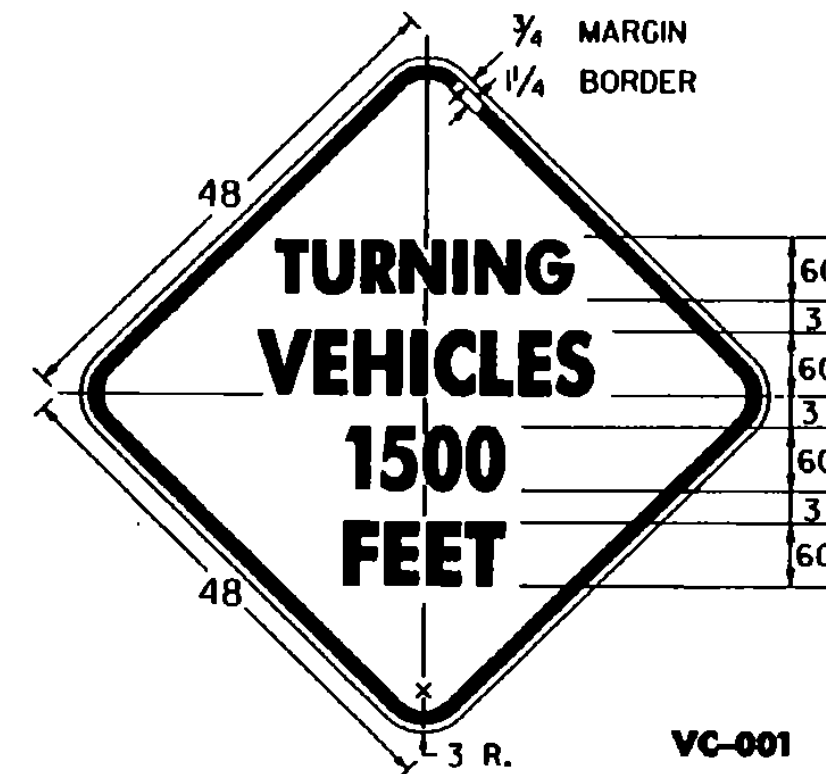

VC-001

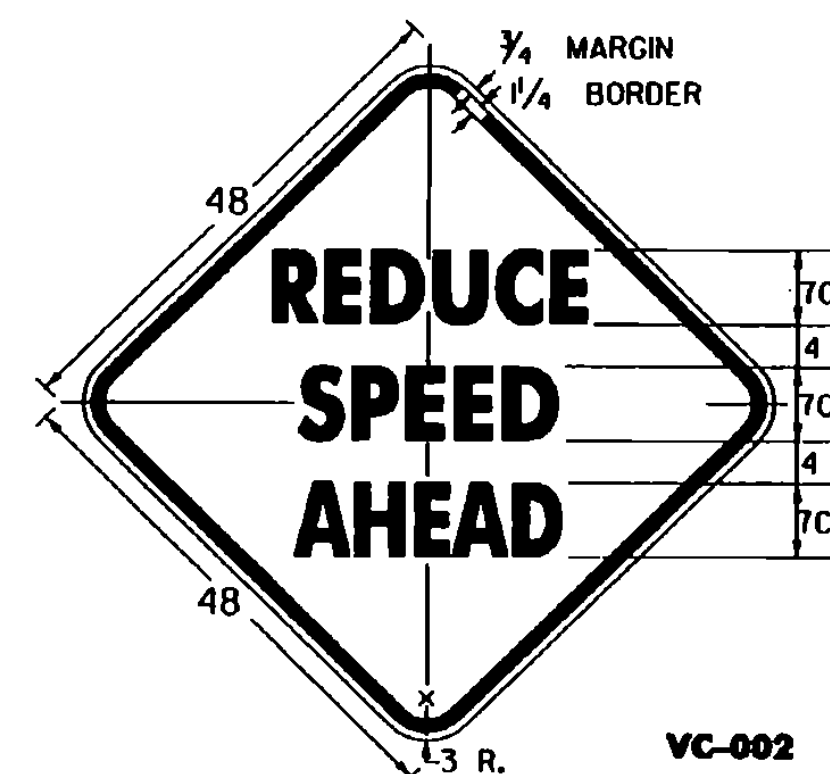

VC-002

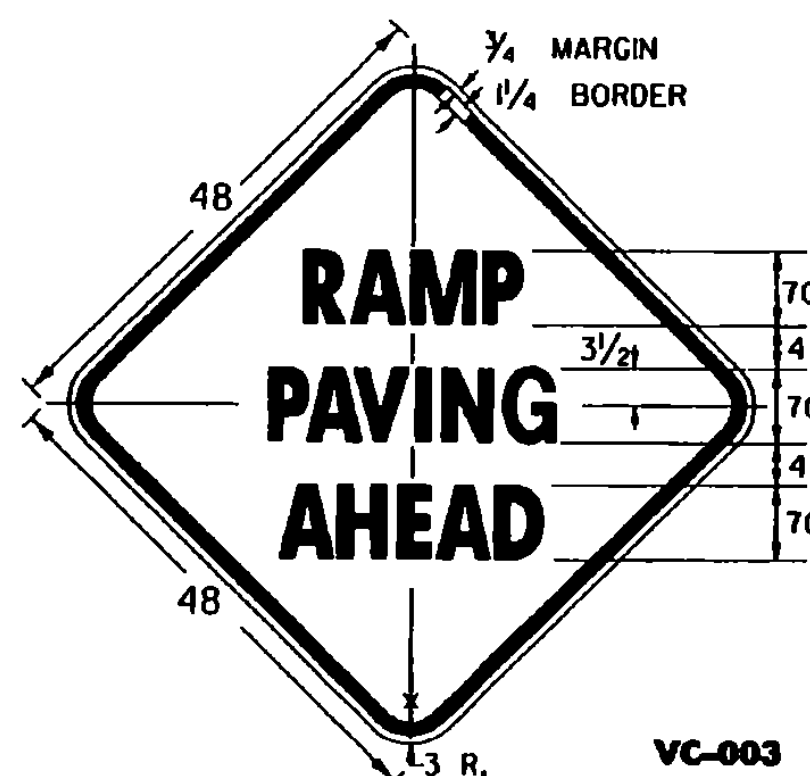

VC-003

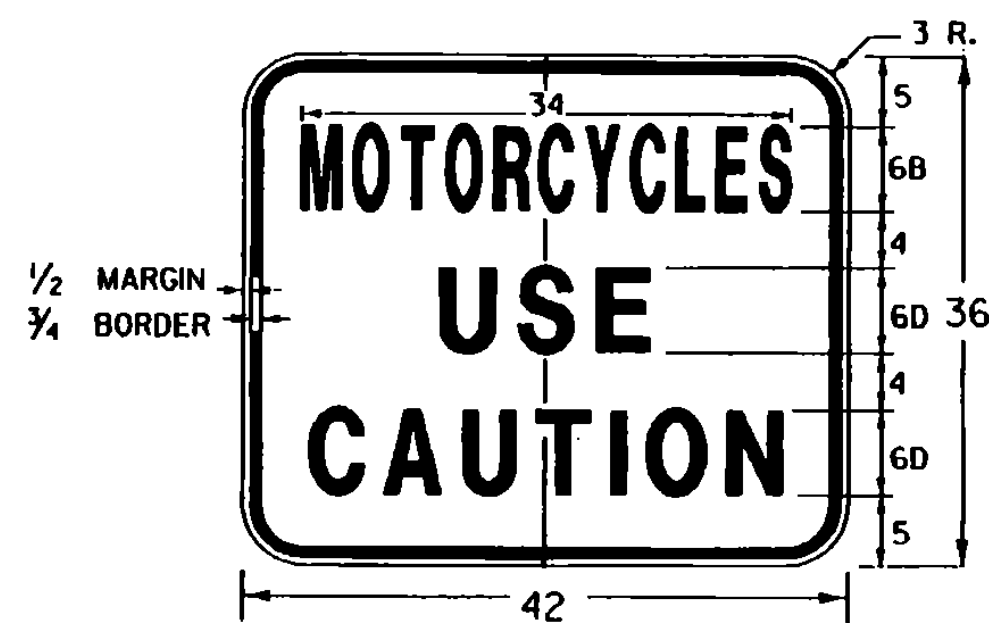

VC-004

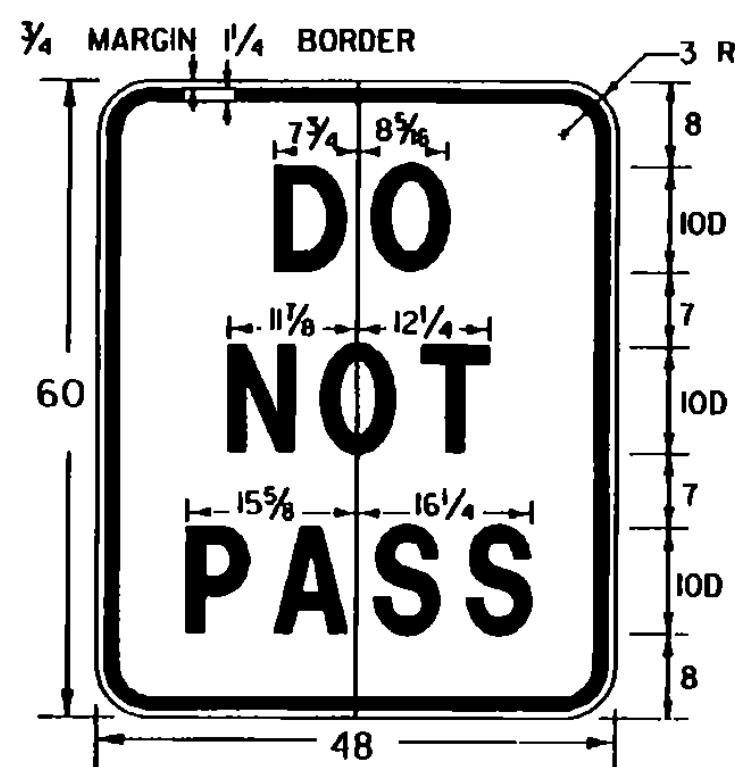

VC-005

* REDUCE SPACING BY 40%

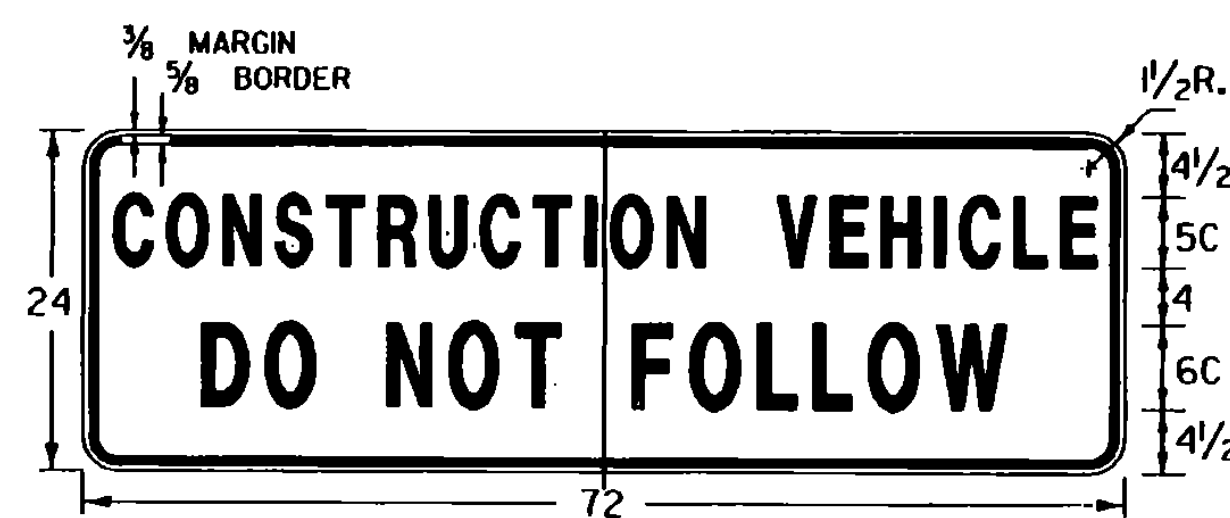

VC-007

IT IS SUGGESTED THAT THIS SIGN BE DESIGNED TO FOLD, (DOWN OR ACROSS), OR BE COVERED, OR BE REMOVED WHEN NOT IN USE. THE SIGN SHOULD ALSO BE MOUNTED AS TO NOT INTERFERE WITH THE VISIBILITY OF DIRECTIONAL OR TAIL LIGHTS AS REQUIRED BY LAW.

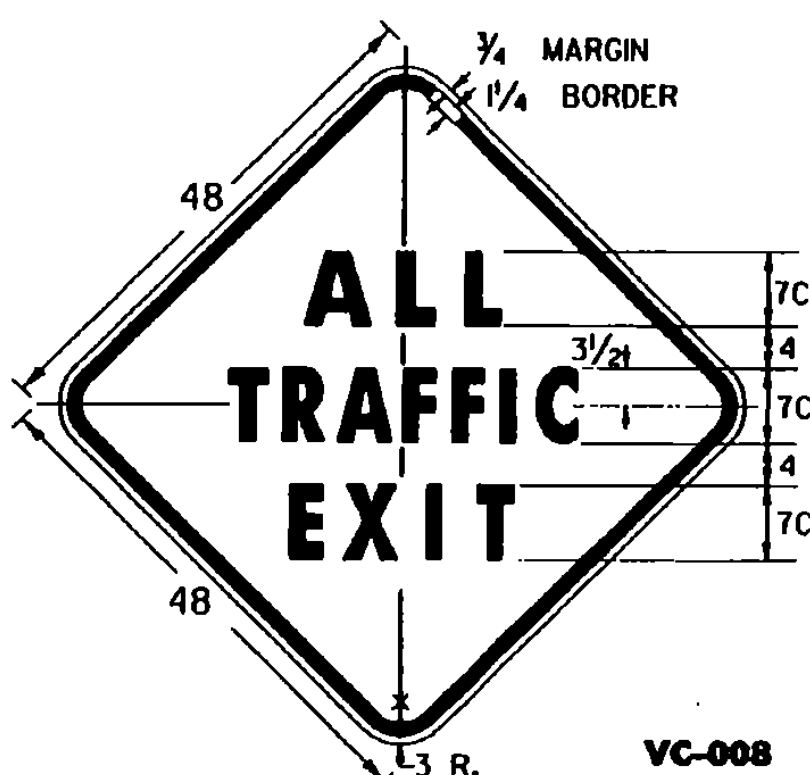

VC-008

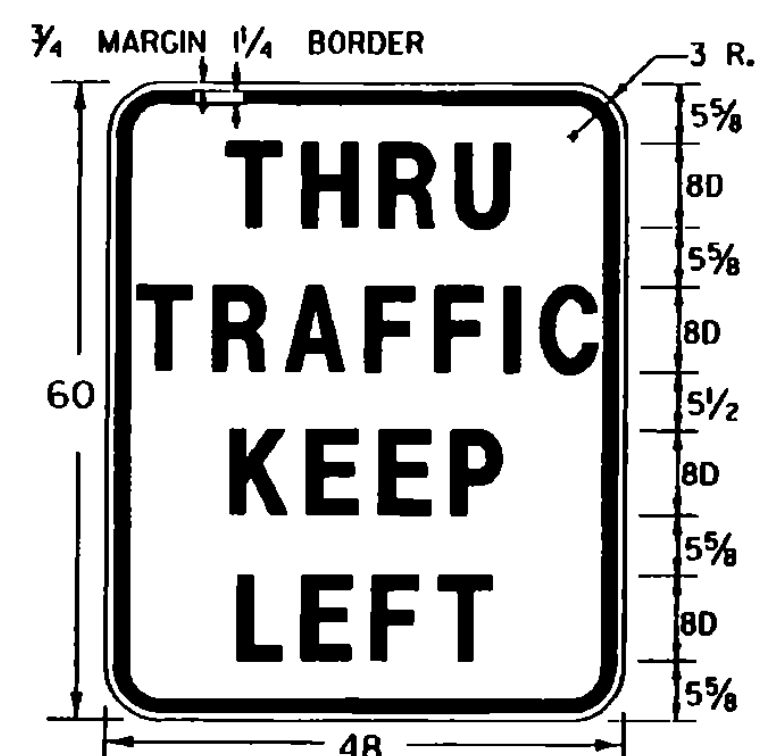

VR-118

COLORS: BLACK BORDER & TEXT
WHITE (REFL.) BACKGROUND

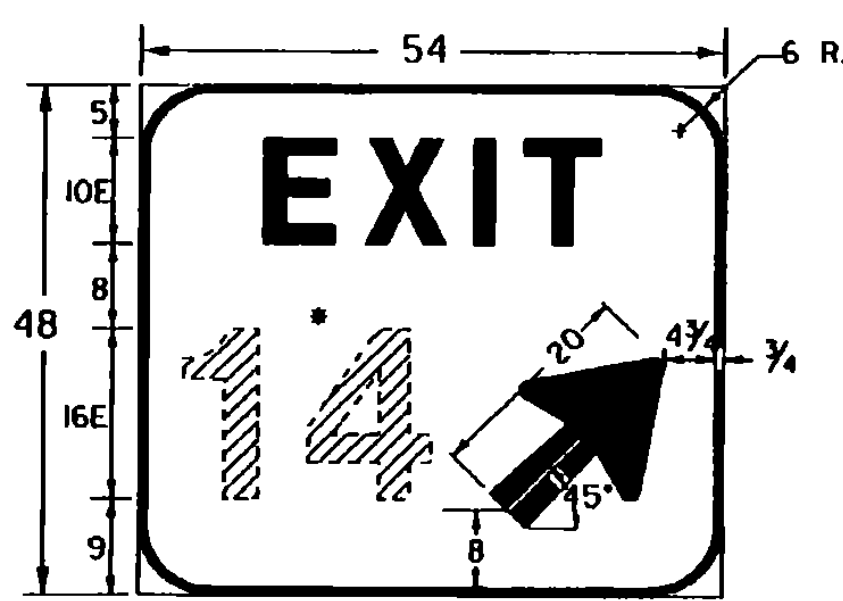

ES-1a

* EXIT NUMBER AS PER PLANS
OPTICALLY SPACED

COLORS:
BACKGROUND - GREEN (REFL.)
BORDER, ARROW AND LEGEND - WHITE (REFL.)

(ALL DIMENSIONS SHOWN IN INCHES)

OTHER STDS. E-100
REQUIRED:

REVISIONS AND CORRECTIONS

AUG 08, 1995 - DATE OF ORIGINAL ISSUE

APPROVED

Stephen D. McCallister
DIRECTOR OF ENGINEERING

David A. Ross
TRAFFIC AND SAFETY ENGINEER

CONSTRUCTION SIGN DETAILS

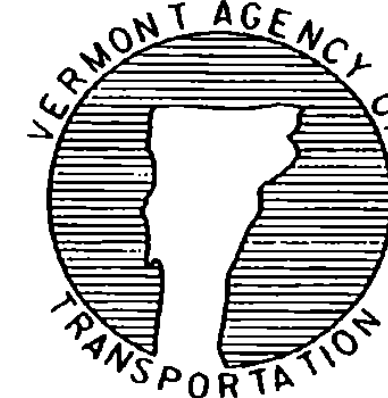

STANDARD E-102A

APPROVED FOR THIS PROJECT
AND/OR DESIGN IMPLEMENTATION
FHWA FINAL APPROVAL PENDING.

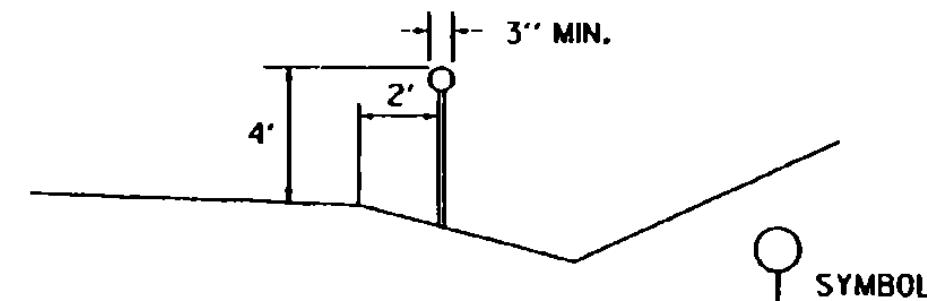
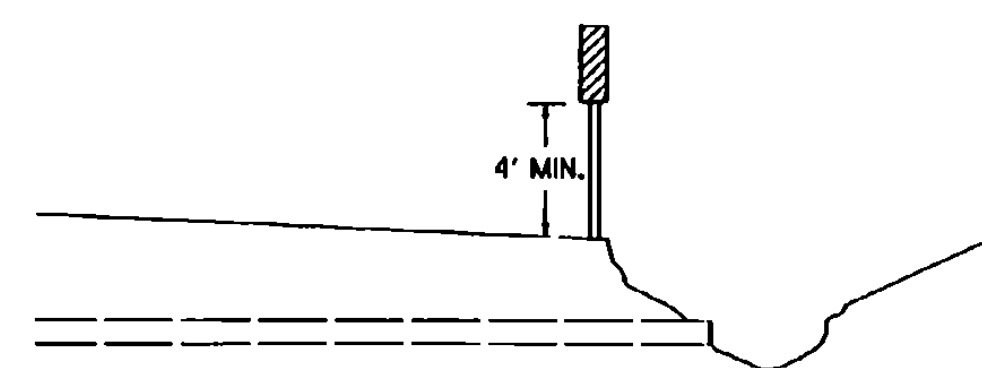

DELINEATOR TYPICAL

DELINEATORS SHALL BE REFLECTORIZED WHITE IN COLOR. THEY SHALL HAVE A MINIMUM OF 7 SQUARE INCHES. THEY MAY BE ROUND, SQUARE, OR OBLONG.

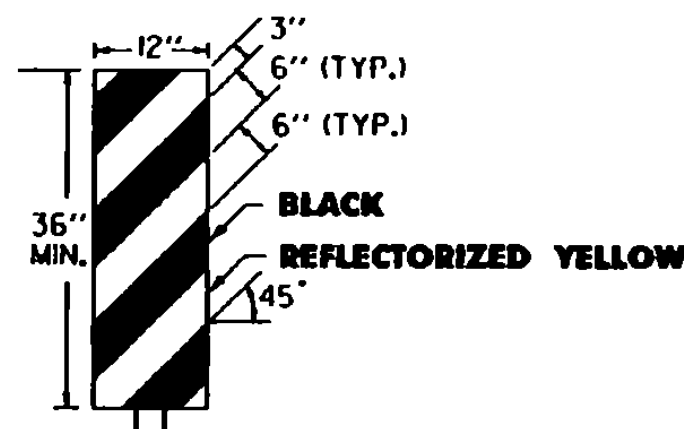

OBJECT MARKER TYPICAL

OBJECT MARKERS ARE USED TO MARK OBSTRUCTIONS WITHIN OR ADJACENT TO THE ROADWAY. IN SOME CASES THERE MAY NOT BE A PHYSICAL OBJECT INVOLVED, BUT OTHER ROADSIDE CONDITIONS SUCH AS NARROW SHOULDER DROP-OFFS, GORES, D.I. EXCAVATIONS, AND ABRUPT CHANGES IN THE ROADWAY ALIGNMENT MAY MAKE IT UNDESIRABLE FOR A DRIVER TO LEAVE THE ROADWAY. THE INSIDE EDGE OF THE OBJECT MARKER SHALL BE IN LINE WITH THE INNER EDGE OF THE OBSTRUCTION, WHENEVER POSSIBLE. OBJECT MARKERS SHALL HAVE ALTERNATING BLACK AND REFLECTORIZED YELLOW STRIPES, (SLOPING DOWNWARD IN THE DIRECTION TRAFFIC IS TO PASS).

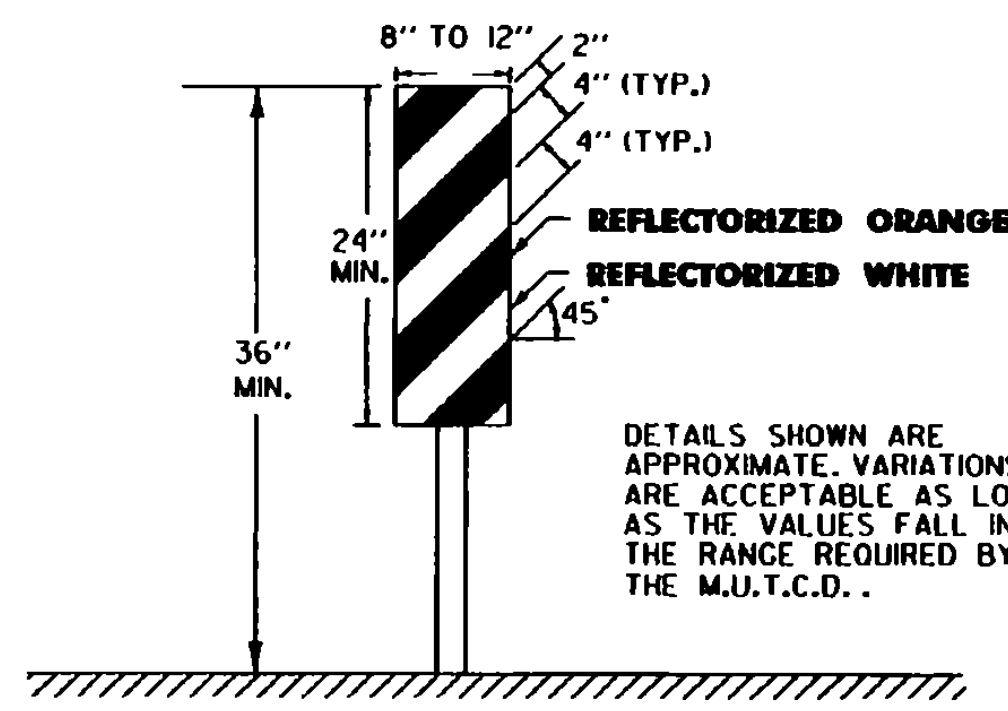

VERTICAL PANEL

VERTICAL PANELS SHALL HAVE ALTERNATING ORANGE AND WHITE REFLECTORIZED STRIPES (SLOPING DOWNWARD IN THE DIRECTION TRAFFIC IS TO PASS). THESE DEVICES MAY BE USED FOR TRAFFIC SEPARATION, CHANNELIZING OR BARRICADING WHERE SPACE IS AT A MINIMUM.

DELINEATOR, VERTICAL PANEL AND OBJECT MARKER DETAILS FOR CONSTRUCTION AREAS WHERE TRAFFIC IS MAINTAINED

ALL SIGN PLACEMENT DISTANCES ARE DESIRABLE SPECIFICATIONS. FIELD CONDITIONS SHALL CONTROL THE ACTUAL PLACEMENT. PROJECT CONSTRUCTION APPROACH SIGNING PLACEMENT SHALL TAKE INTO CONSIDERATION SPACING REQUIREMENTS FOR THE DETOUR SIGN LAYOUT REQUIREMENTS.

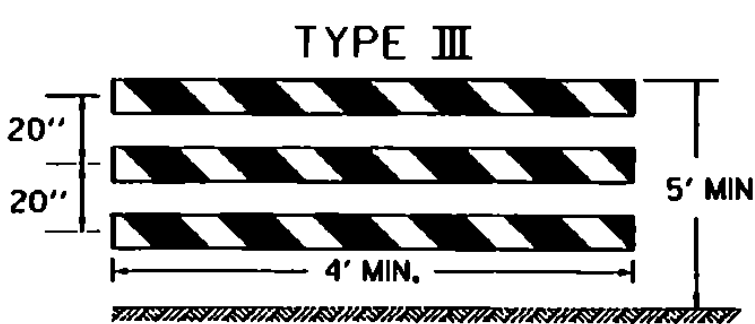
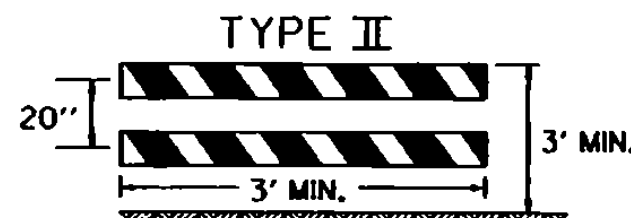
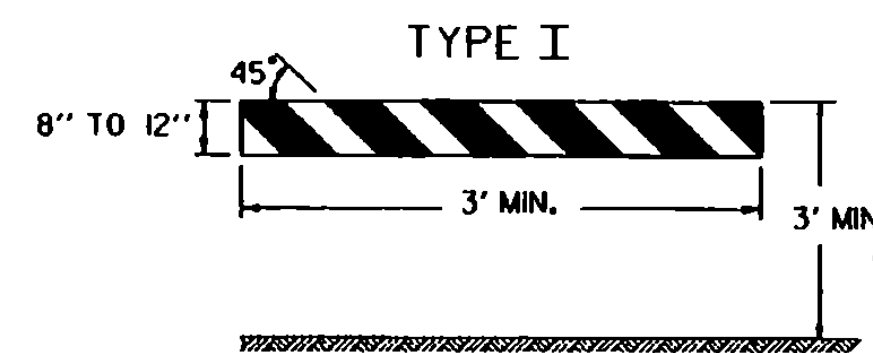

A TYPE III (MODIFIED) BARRICADE SHALL CONSIST OF TYPE II RAILS MOUNTED ON A BREAKAWAY BARRICADE AS SHOWN ON STANDARD SHEET E-107A.

BARRICADE CHARACTERISTICS

	BARRICADE CHARACTERISTICS		
	I	II	III
WIDTH OF RAIL	8" MIN. 12" MAX.	8" MIN. 12" MAX.	8" MIN. 12" MAX.
LENGTH OF RAIL	3' MIN.	3' MIN.	4' MIN.
WIDTH OF STRIPES	6"	6"	6"
HEIGHT	3' MIN.	3' MIN.	5' MIN.
TYPE OF FRAME	SEE E-107A	SEE E-107A	SEE E-107A
FLEXIBILITY	PORTABLE	PORTABLE	PORTABLE
ANGLE OF STRIPE	45°	45°	45°
COLOR OF STRIPES	ORANGE AND WHITE	ORANGE AND WHITE	ORANGE AND WHITE

DETOUR DESIGN SPEED (M.P.H.)	MINIMUM RADIUS (FT.) ^a				
	SUPERELEVATION (FT./FT.)				
	0.00 ^b	0.02	0.04	0.06	0.08
20	160	140	130	120	110
25	245	220	200	185	170
30	375	335	305	275	255
35	510	455	410	375	340
40	715	630	575	510	470
50	1190	1045	955	850	765

a. PER AASHTO REQUIREMENTS
b. 0.00 SUPERELEVATION SHOULD BE AVOIDED IF POSSIBLE

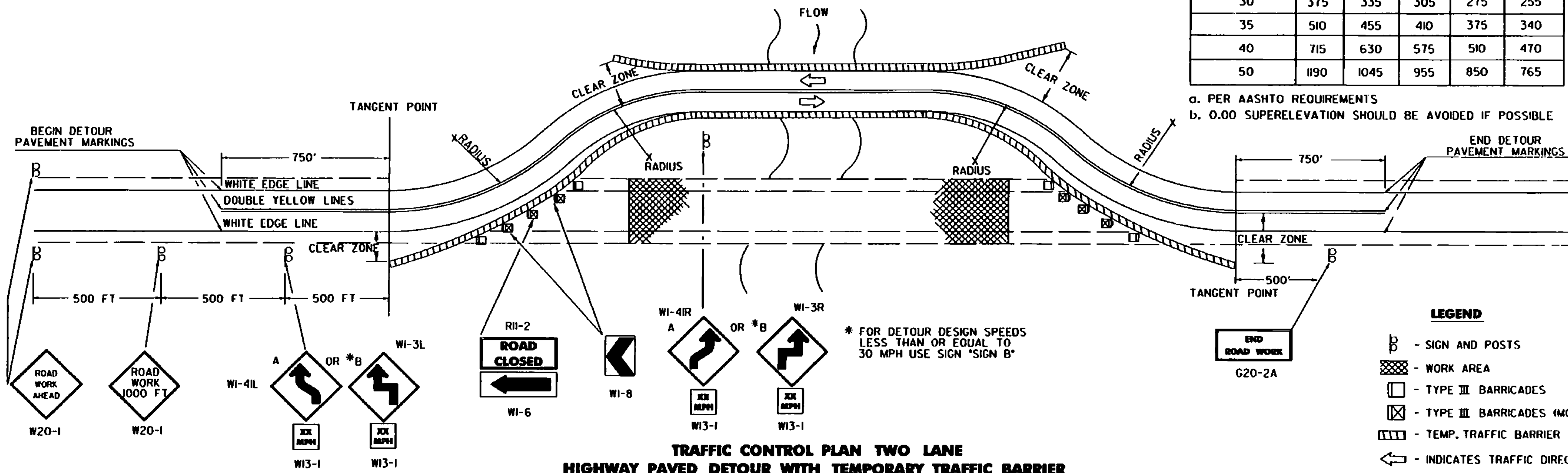

TRAFFIC CONTROL PLAN TWO LANE HIGHWAY PAVED DETOUR WITH TEMPORARY TRAFFIC BARRIER

BARRICADES

APPLICATION NOTES

TYPE I BARRICADES SHALL BE USED ON CONVENTIONAL ROADS OR URBAN STREETS AND ARTERIALS TO MARK A SPECIFIC HAZARD.

TYPE II BARRICADES SHALL BE USED ON EXPRESSWAYS AND FREEWAYS, SERVING THE SAME FUNCTIONS AS TYPE I BARRICADES.

TYPE III BARRICADES (SEE STD. E-107A) SHALL ONLY BE USED WHEN A ROAD SECTION OR LANE IS CLOSED TO TRAFFIC AND ARE TO BE ERRECTED AT THE POINT OF CLOSURE.

MATERIALS

THE BARRICADES SHOWN ON THIS SHEET SHOULD BE OF LIGHTWEIGHT MATERIAL. IF WOOD IS USED THE FOLLOWING CONDITIONS SHALL APPLY:

- WOODEN BARRICADES (TYPE I AND II)
 - SHALL NOT BE USED TO CHANNELIZE OR DELINEATE WORK AREAS WITHIN THE CLEAR ZONE OF ANY HIGHWAY WHERE OPERATING SPEEDS IN EXCESS OF 20 M.P.H. ARE EXPECTED UNLESS INSTALLED FOR PEDESTRIAN CONTROL BEHIND APPROVED POSITIVE BARRIERS.
 - MAY BE USED WHERE OPERATING SPEEDS OF 20 M.P.H. OR LESS ARE EXPECTED.
- TYPE III WOODEN BARRICADES SHALL NOT BE USED.

COLORS

THE BARRICADE PANELS SHOWN ON THIS SHEET SHALL HAVE AN ALTERNATING REFLECTORIZED WHITE AND ORANGE STRIPES. THE ORANGE SHALL CONFORM WITH THE STANDARD COLORS ADOPTED BY THE AMERICAN ASSOCIATION OF STATE HIGHWAY AND TRANSPORTATION OFFICIALS AND APPROVED BY THE U.S. DEPARTMENT OF TRANSPORTATION FEDERAL HIGHWAY ADMINISTRATION. THE BARRICADE COMPONENTS SHALL BE WHITE UNLESS UNPAINTED METAL OR ALUMINUM IS USED.

REFLECTORIZATION

THE REFLECTIVE SHEETING ON BARRICADE PANELS SHALL BE TYPE III.

LOCATION

THE BARRICADES SHOWN ON THIS SHEET WILL BE LOCATED BY THE RESIDENT ENGINEER IN THE FIELD OR AS SHOWN ON THE PLANS. THE LOCATION OF THE BARRICADES SHALL FOLLOW THE PROCEDURES SET FORTH IN THE "MANUAL ON UNIFORM TRAFFIC CONTROL DEVICES", OR AS OTHERWISE NOTED.

MAINTENANCE

BARRICADES SHALL BE MAINTAINED IN CLEAN CONDITION. SATISFACTORY TO THE RESIDENT ENGINEER. THEY SHALL BE COMPLETELY VISIBLE TO THE APPROACHING TRAFFIC AT ALL TIMES. DAMAGED, DEFACED, OR DIRTY BARRICADES SHALL BE REPAIRED, CLEANED, OR REPLACED AS ORDERED BY THE RESIDENT ENGINEER.

DETOUR NOTES

- SIGNS AND DELINEATION SHOWN FOR ONE DIRECTION OF TRAFFIC ONLY.
- THE CONTRACTOR IS RESPONSIBLE FOR PAVEMENT MARKING AND SHALL REMOVE ANY CONFLICTING OR CONFUSING EXISTING MARKINGS.
- ADDITIONAL SIGNING MAY BE REQUIRED AT THE DISCRETION OF THE RESIDENT ENGINEER.
- UNPAVED DETOURS REQUIRE PAVEMENT MARKINGS FOR TRANSITIONS FROM EXISTING PAVEMENT.
- THE NUMBER OF CHANNELIZING DEVICES, BARRICADES AND OTHER TRAFFIC CONTROL DEVICES SHOWN ON THIS SHEET ARE FOR ILLUSTRATIVE PURPOSES ONLY. THE ACTUAL NUMBER REQUIRED SHALL BE DETERMINED BASED ON INDIVIDUAL DETOUR CONDITIONS (TAPERS, SPEED LIMITS, LENGTH OF DETOUR CURVE, ETC.).
- AASHTO CLEAR ZONE REQUIREMENTS SHOULD BE MET. IF NOT THEN AN APPROVED ENERGY ABSORPTION ATTENUATOR SUITABLE FOR THE TEMPORARY TRAFFIC BARRIER USED AND FOR THE DESIGN SPEED SHALL BE INSTALLED PER THE CURRENT AASHTO ROADSIDE DESIGN GUIDE.
- THE DETOUR DESIGN SPEED SHOULD BE NO LESS THAN 10 M.P.H. BELOW THE POSTED SPEED LIMIT, UNLESS PHYSICAL RESTRICTIONS PREVENT THIS.
- SEE STANDARD SHEETS E-100, E-101 AND E-102 FOR SIGN DETAIL AND MATERIAL REQUIREMENTS.
- IF THE USE OF TEMPORARY TRAFFIC BARRIER IS NOT REQUIRED, THEN REFLECTORIZED PLASTIC DRUMS SHALL BE USED.

OTHER STDS. REQUIRED:	E-100 E-101	E-102 E-102a	E-107a
------------------------------	-----------------------	------------------------	---------------

REVISIONS AND CORRECTIONS

SEPT. 10, 1987 - DATE OF ORIGINAL ISSUE
APRIL 29, 1988 - FHWA REVIEW COMMENTS
SEPT. 20, 1993 - NEW RADIUS CHART, BARRICADE ALIGNMENT AND USE OF TEMPORARY TRAFFIC BARRIER
AUG. 08, 1995 - REVISED SIGNING PER MUTCD

APPROVED FOR THIS PROJECT AND/OR DESIGN IMPLEMENTATION, FHWA FINAL APPROVAL PENDING.

APPROVED

Stephen D. MacAllister
DIRECTOR OF ENGINEERING

Dan A. Ross
TRAFFIC AND SAFETY ENGINEER

DELINEATION, BARRICADES AND DETOURS FOR CONSTRUCTION AREAS

VERMONT AGENCY OF TRANSPORTATION

STANDARD E-107

/traf/std/std07.dgn : std07.1

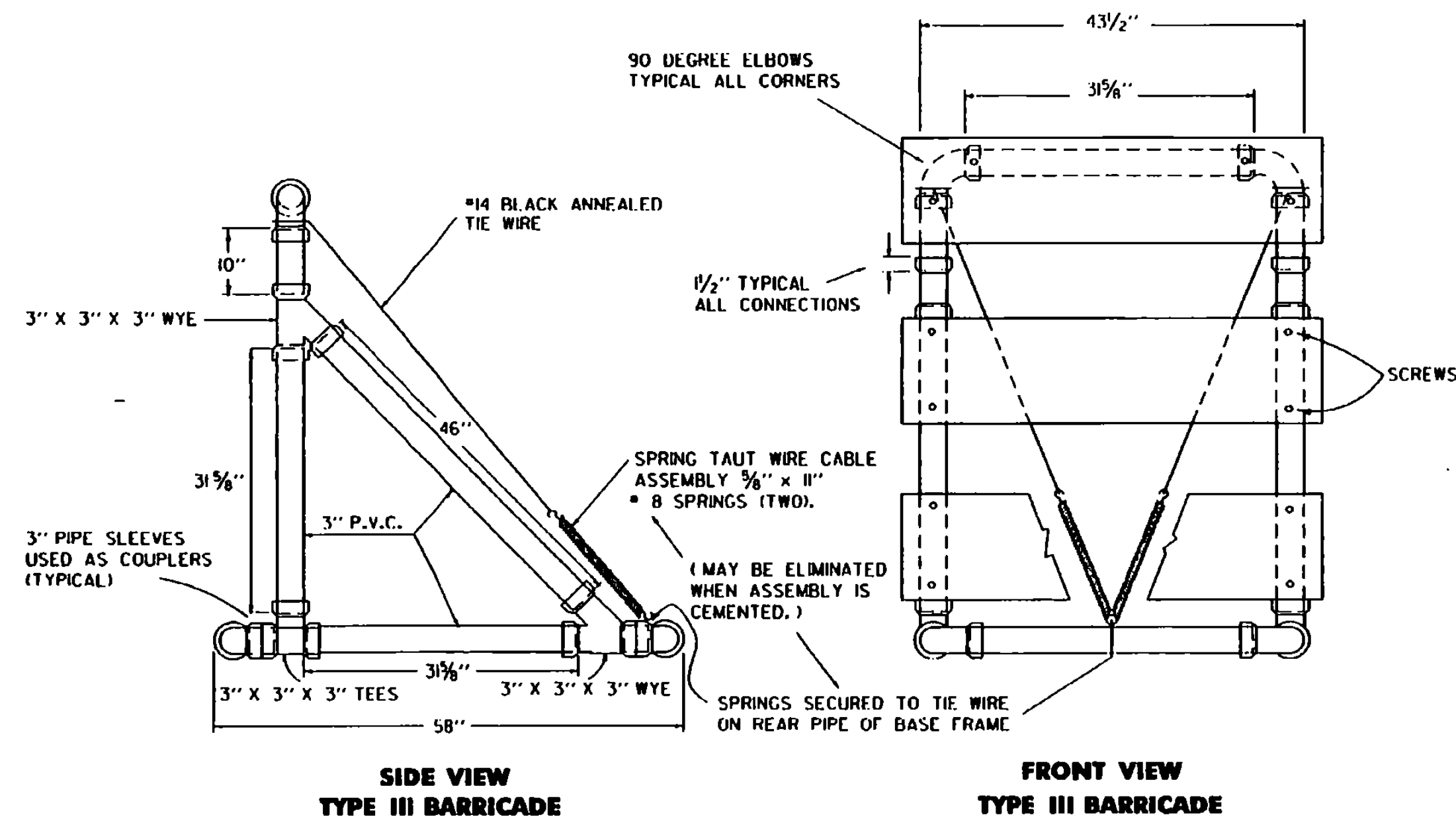

- MATERIALS FOR TYPE I AND II BARRICADES**
- 20' - 1" PVC
 - 4 - 1" PVC 90° ELBOWS
 - 30" - 1/2" ID THINWALL PVC CONDUIT
 - 36" - 1/4" STEEL ROD
 - 4 - 1" WASHERS
 - 24" - LIGHT DUTY CHAIN
 - 1/2" - #14 PAN HEAD METAL SCREWS (AS REQUIRED)
 - 2 - 3/4" COTTER PINS
 - 2 OR 4 - 8" OR 12" X 36" X 0.025" BARRICADE RAILS (AS REQUIRED)

- MATERIALS FOR TYPE III BARRICADES**
- 30 LF - 3" I.D. PVC PIPE
 - 6 - 3" 90° ELBOWS
 - 2 - 3" TEES
 - 4 - 3" WYES
 - 3 - 8" OR 12" X 48" X 0.025" BARRICADE RAILS
 - 2 - 5/8" X 11" #8 SPRING (IF ASSEMBLY IS NOT CEMENTED)
 - 12 - 1" #14 PAN HEAD METAL SCREWS
 - 15 LF - #14 BLACK ANNEALED TIE WIRE (IF ASSEMBLY IS NOT CEMENTED)

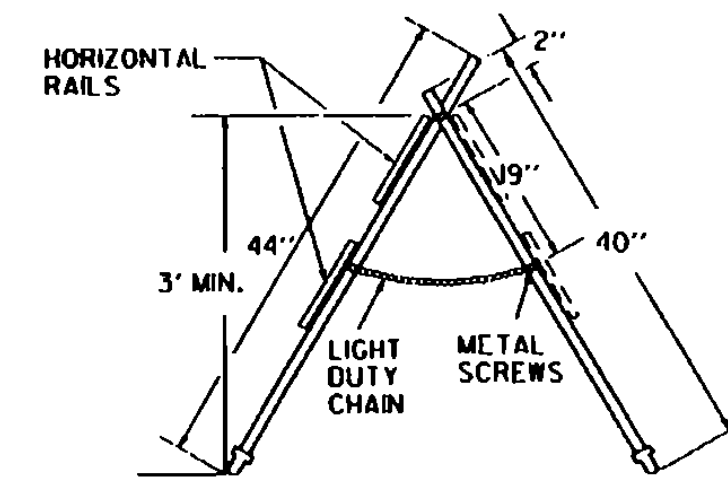

MATERIALS

THE PIPE, WYES, TEES AND ELBOWS USED TO CONSTRUCT BARRICADES SHALL CONFORM TO THE REQUIREMENTS OF ASTM DESIGNATION D 2241 FOR P.V.C. 1120 OR 1220 SDR-21, PRESSURE RATING 200 PSI. THE WYES, TEES AND ELBOWS SHALL CONFORM TO THE REQUIREMENTS OF ASTM DESIGNATION D 2466, TYPE II, GRADE I. ALL JOINTS SHALL BE SLIP-FIT AND MAY BE LIGHTLY CEMENTED. THE BARRICADE RAILS SHALL BE FABRICATED FROM 0.025" ANODIZED ALUMINUM AND SHALL HAVE REFLECTORIZED ALTERNATING ORANGE AND WHITE STRIPES (SLOPING DOWNWARD AT AN

MAINTENANCE

BARRICADES SHALL BE MAINTAINED IN CLEAN AND LEGIBLE CONDITIONS SATISFACTORY TO THE ENGINEER. THEY SHALL BE COMPLETELY VISIBLE TO APPROACHING TRAFFIC AT ALL TIMES. DAMAGED, DEFACED, OR DIRTY BARRICADES SHALL BE REPAIRED, CLEANED OR REPLACED AS ORDERED BY THE ENGINEER. THE P.V.C. PIPE AND FITTINGS SHALL BE WHITE IN COLOR. AT LEAST TWO (2) HOLES SHALL BE DRILLED (3/8" DIAM.) IN EACH SECTION OF PIPE AND FITTINGS IF THE ASSEMBLY IS NOT CEMENTED.

WHICH WILL NOT CONSTITUTE A HAZARD IF THE BARRICADE IS HIT. THESE SHALL BE PLACED ONLY ON THE FRONT AND REAR PIPES OF THE BASE FRAME BE A HAZARD TO VEHICLES PASSING ON EITHER SIDE. GLUED JOINTS MAY PROVIDE ADDITIONAL STABILITY TO THE INSTALLATION.

TYPE I BARRICADES SHALL UTILIZE ONE HORIZONTAL RAIL IN EACH DIRECTION.

TYPE II BARRICADES SHALL BE A TYPE I BARRICADE WITH AN ADDITIONAL HORIZONTAL RAIL MOUNTED BELOW THE OTHER IN EACH DIRECTION.

TYPE III BARRICADES (MODIFIED) SHALL CONSIST OF THE BREAKAWAY 3" PVC DESIGN SHOWN ON THIS SHEET WITH THE TWO RAIL LAYOUT DETAILED ABOVE LEFT.

SEE STD E-107 FOR ADDITIONAL INFORMATION.

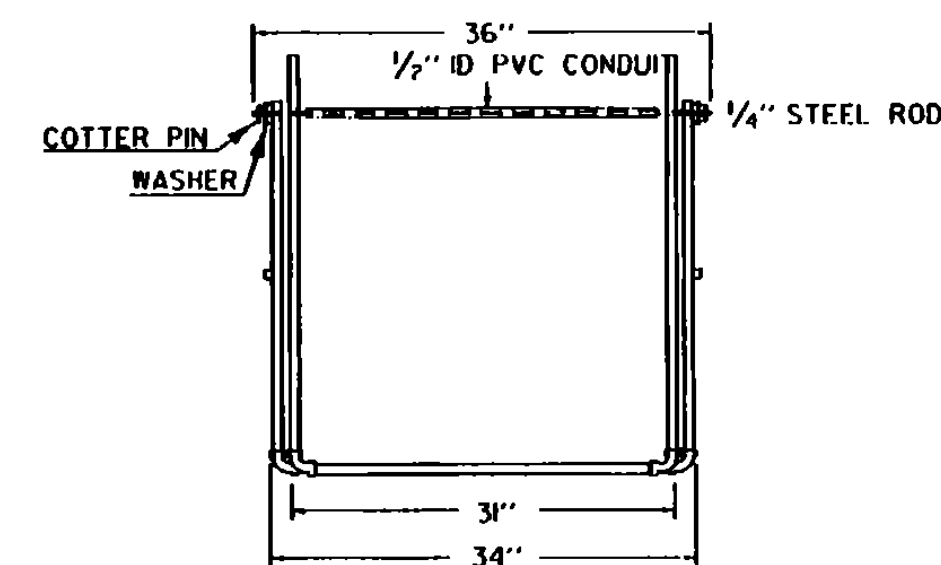

TYPE I AND TYPE II BARRICADE

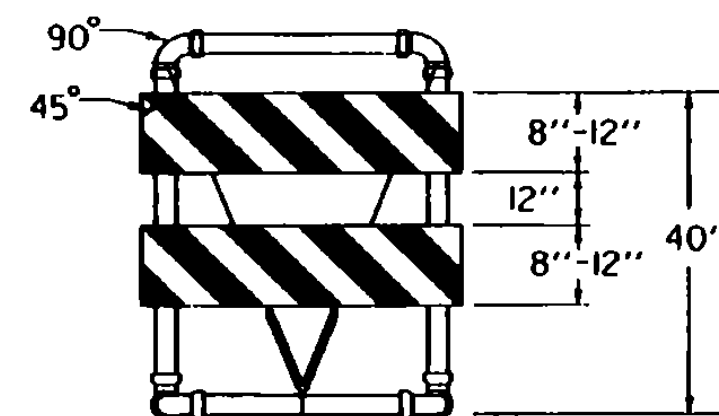

TYPE III (MODIFIED) BARRICADE
(STRIPING IS SHOWN WITH TRAFFIC PASSING TO THE RIGHT).

MATERIALS FOR METAL TYPE III BARRICADES

- PANELS (3):**
- 8' x 48" GALVANIZED STEEL... COVERED
 - 1 OR 2 SIDES WITH WHITE/ORANGE, DIAGONALLY STRIPED REFLECTIVE SHEETING
- VERTICAL SUPPORTS (2):** 14 GAGE GALVANIZED TUBING 1 3/4" X 1 3/4" X 60"
- HORIZONTAL SUPPORTS (2):** 14 GAGE GALVANIZED TUBING 1 3/4" X 1 3/4" X 48"
- CROSS BEAM SUPPORT (1):** COLD GALVANIZED STEEL 1/4" X 3" X 43 3/4"
- BREAKAWAY BRACKETS (4):** COLD GALVANIZED STEEL 1/4" X 3" X 5"
- FASTENERS:**
- 6 - SHEAR BOLTS WITH LOCK NUTS 1/4" D X 2 3/4"
 - 4 - FULCRUM BOLTS WITH LOCK NUTS 3/8" D X 2 3/4"
 - 4 - FASTENER BOLTS WITH LOCK NUTS 3/8" D X 2 3/4"
 - 6 - PANEL BOLTS WITH LOCK NUTS AND WASHERS 1/4" D X 2"
- ALL FASTENERS GALVANIZED STEEL.
ALL BOLTS HEX HEAD.

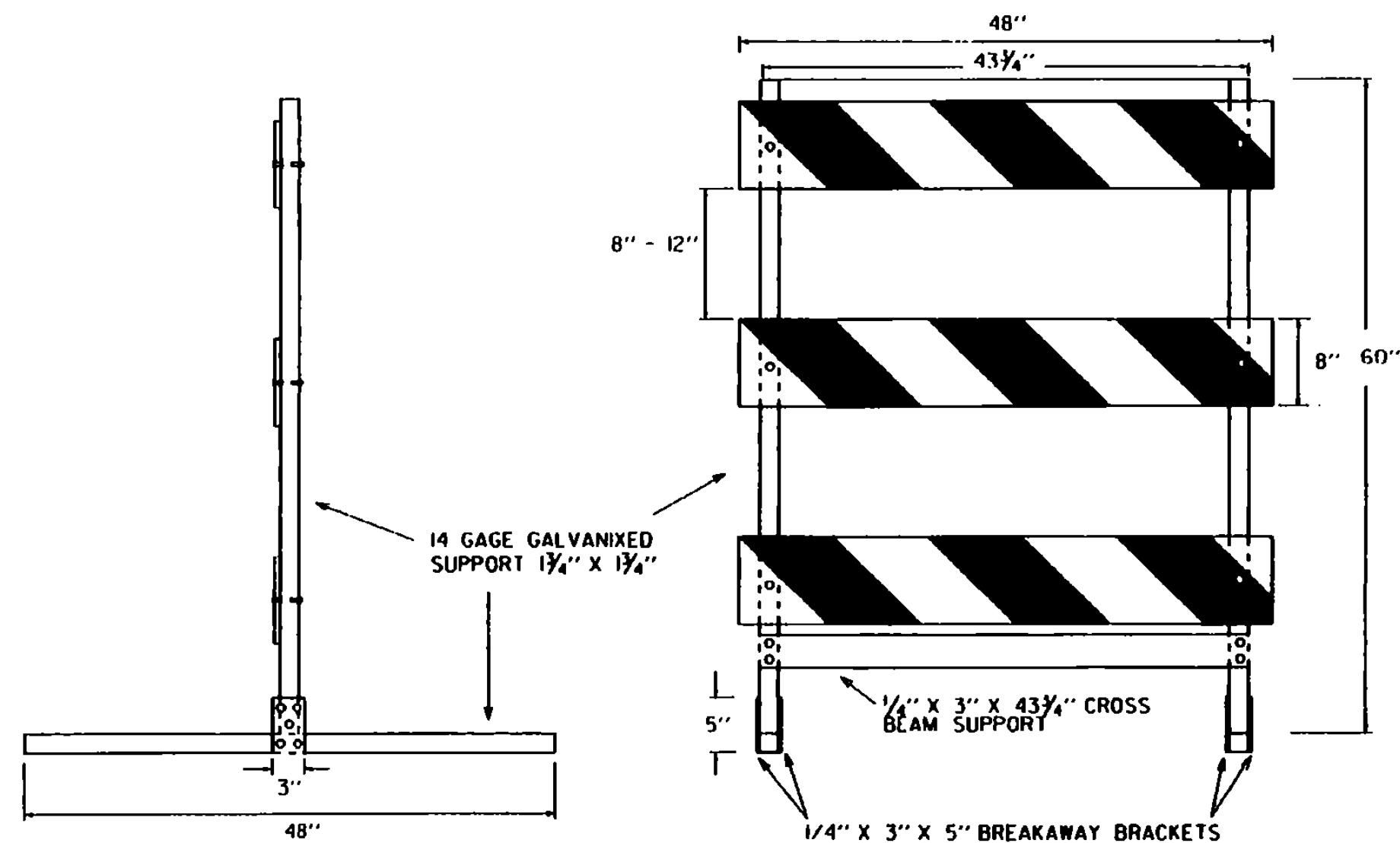

SIDE AND FRONT VIEW OF TYPE III METAL BARRICADE

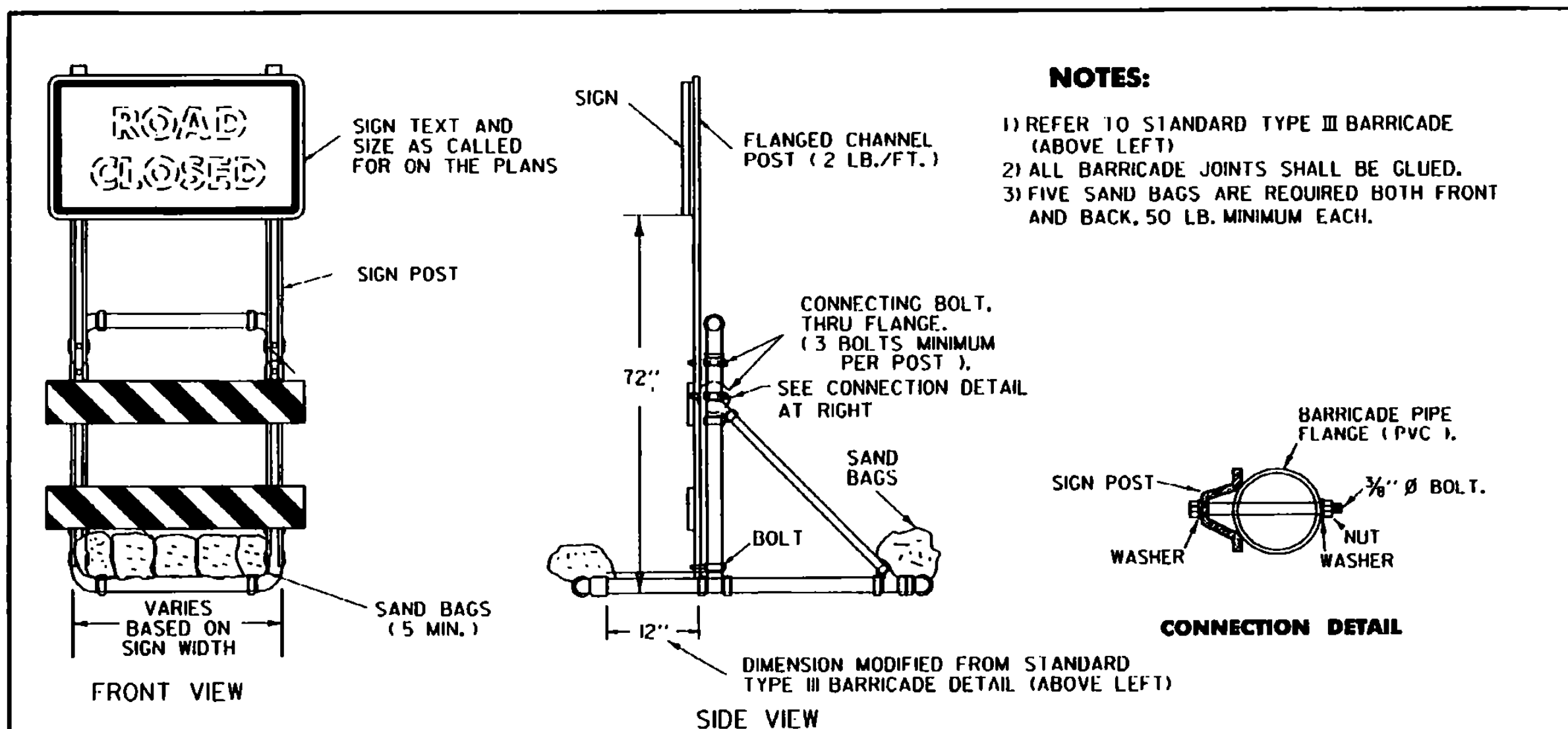

NOTES:

- REFER TO STANDARD TYPE III BARRICADE (ABOVE LEFT)
- ALL BARRICADE JOINTS SHALL BE GLUED.
- FIVE SAND BAGS ARE REQUIRED BOTH FRONT AND BACK, 50 LB. MINIMUM EACH.

SIGN MOUNTING ON TYPE III BARRICADE (MODIFIED)

OTHER STDS. REQUIRED: E-107

REVISIONS AND CORRECTIONS

- SEPT. 10, 1987 - ADDED METAL TYPE III BARRICADE
- SEPT. 20, 1993 - REVISED NOTES AND TYPE III (MOD.) BARRICADE DETAIL
- AUG. 08, 1995 - ADDED METAL TYPE III BARRICADE

APPROVED FOR THIS PROJECT AND/OR DESIGN IMPLEMENTATION. FHWA FINAL APPROVAL PENDING.

APPROVED

Stephen D. MacArthur
DIRECTOR OF ENGINEERING

D. J. O. Row
TRAFFIC AND SAFETY ENGINEER

BREAKAWAY BARRICADE DETAILS



STANDARD E-107 A