

COLOR: BLACK BORDER & TEXT
YELLOW BACKGROUND (REFLECTORIZED)
MATERIAL: PER VAOT STANDARD E-153M

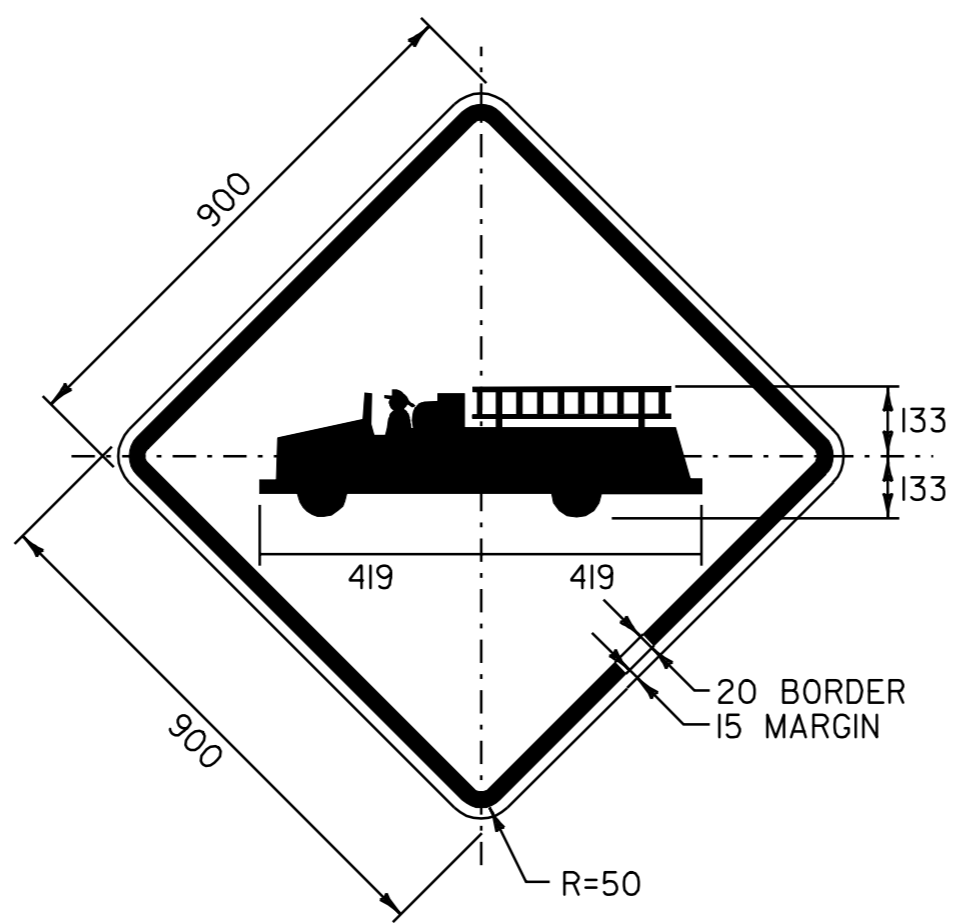

COLOR: BLACK BORDER & TEXT
YELLOW BACKGROUND (REFLECTORIZED)
MATERIAL: PER VAOT STANDARD E-153M
SIGN - VT. ROUTE 103

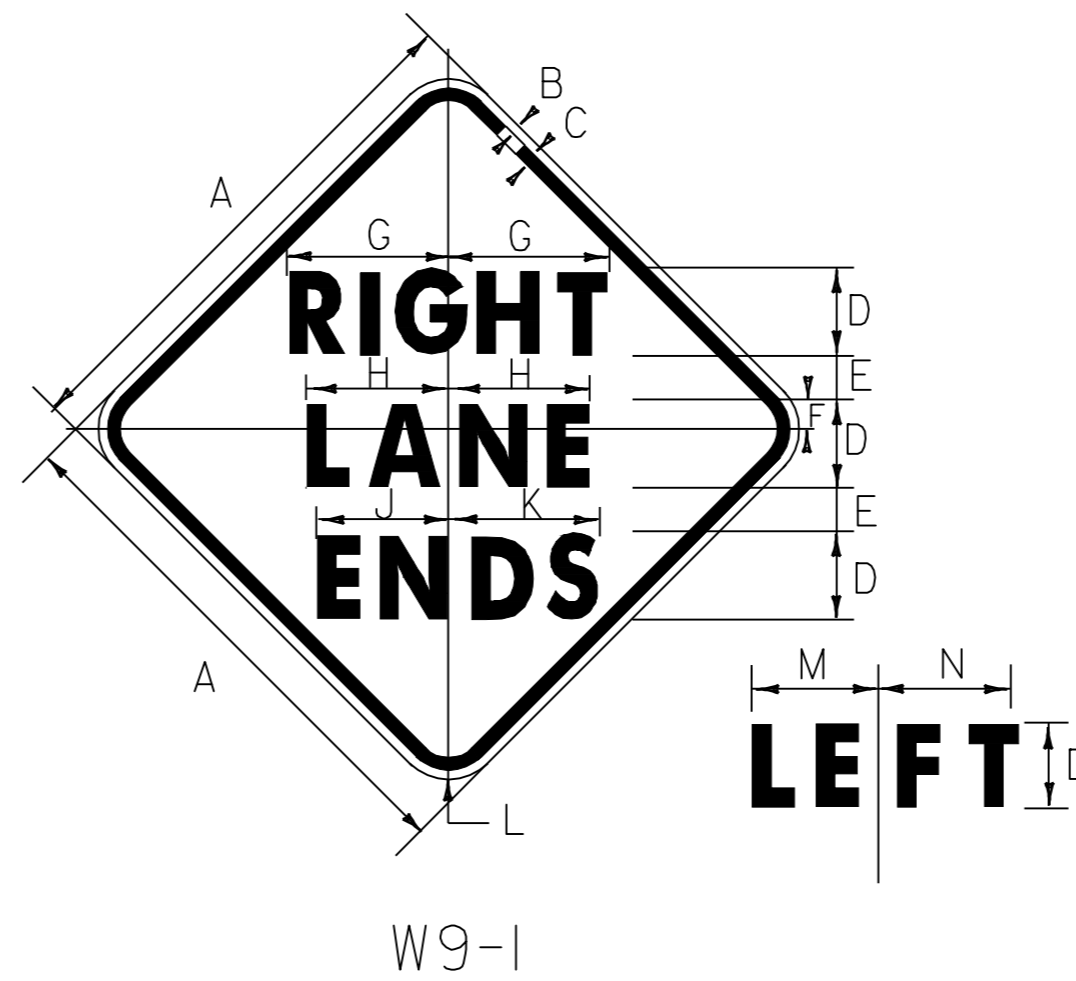
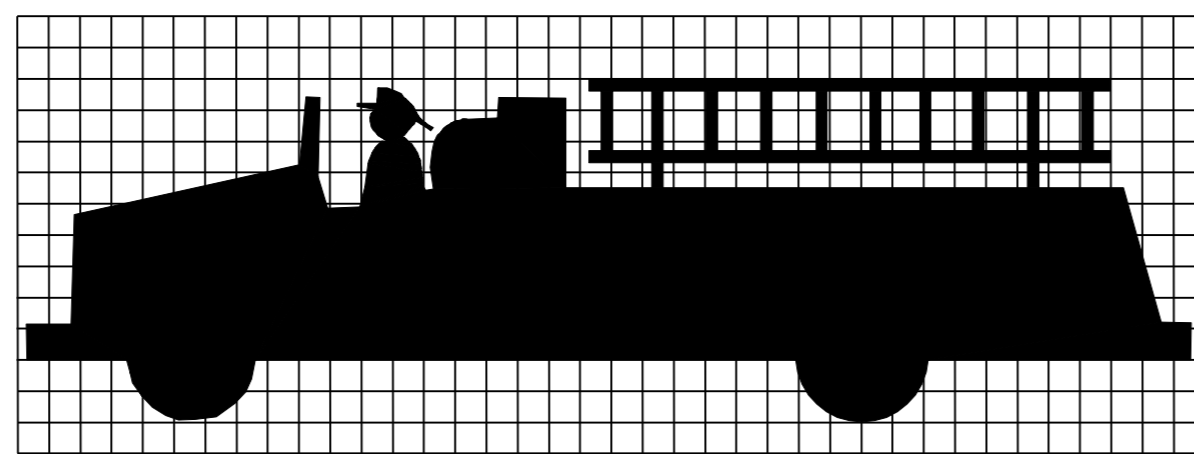

SIGN	DIMENSIONS (MM)											
	A	B	C	D	E	F	G	H	J	K	L	
MIN.	600	10	15	100	50	40	190	160	155	170	40	
STD.	750	10	20	200	60	40	230	200	190	220	50	
EXPWY.	900	15	20	500	75	50	280	250	230	260	60	
SPECIAL	1200	20	30	2000	100	75	375	330	300	350	75	

M	N
145	150
180	190
215	230
350	300

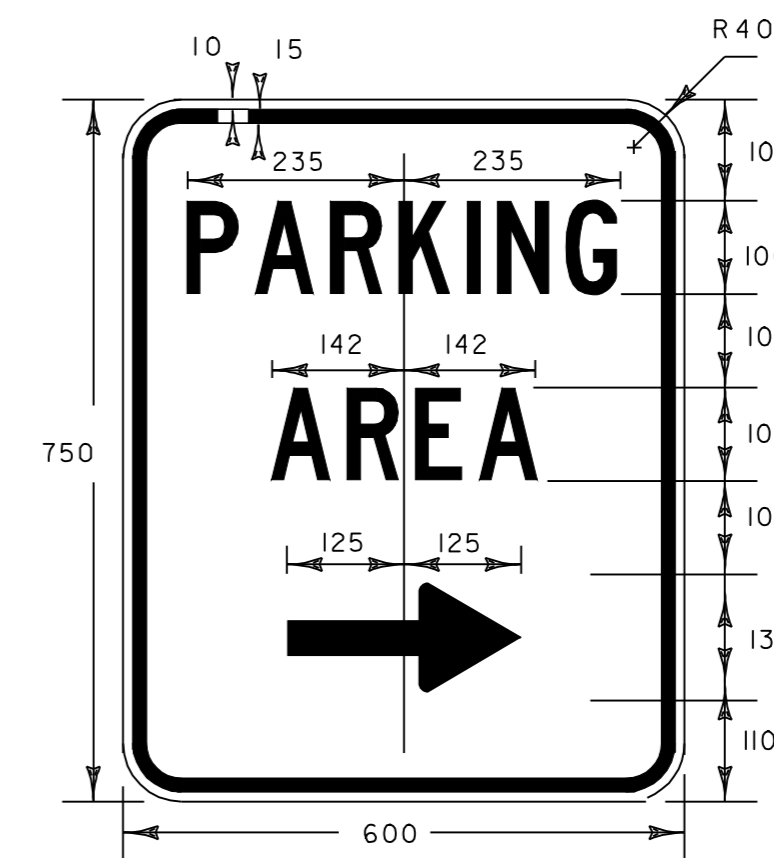

VD-618A(R)

WHITE TEXT + BORDER
BLUE BACKGROUND

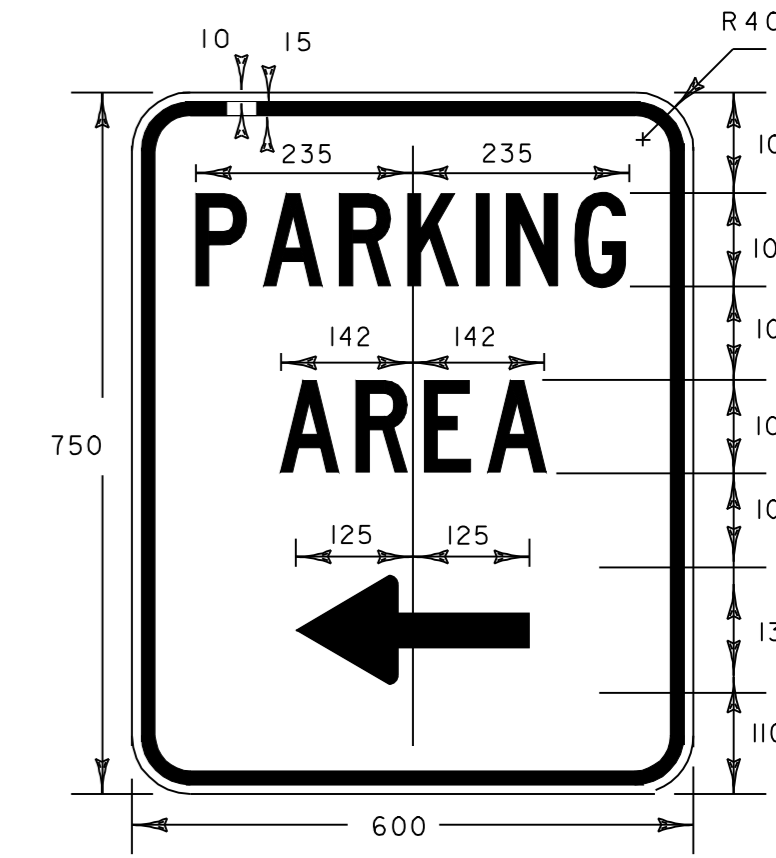

VD-618A(L)

WHITE TEXT + BORDER
BLUE BACKGROUND

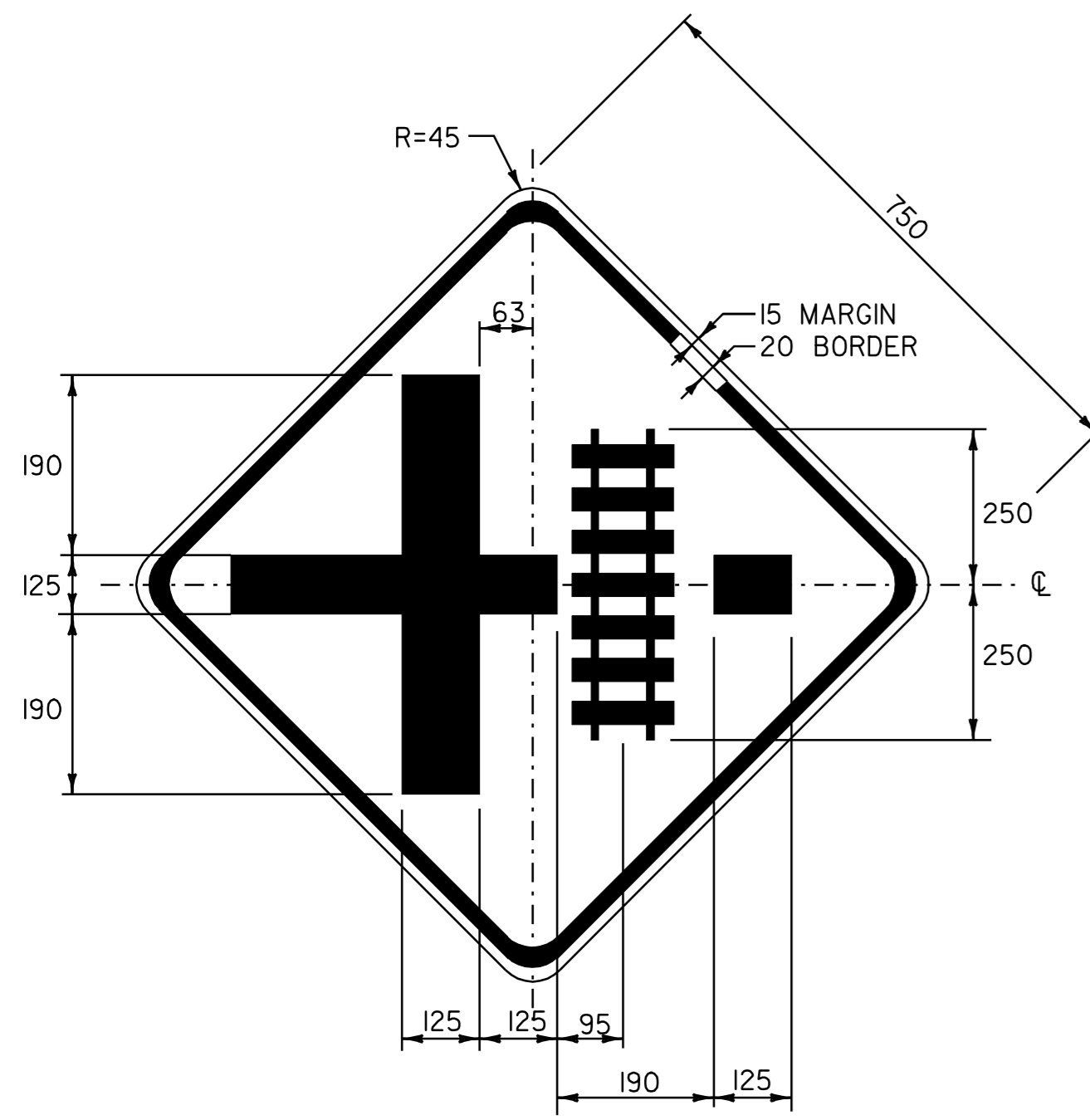

COLOR: BLACK BORDER & TEXT
YELLOW BACKGROUND (REFLECTORIZED)
MATERIAL: PER VAOT STANDARD E-153M
SIGN - VT. ROUTE 103

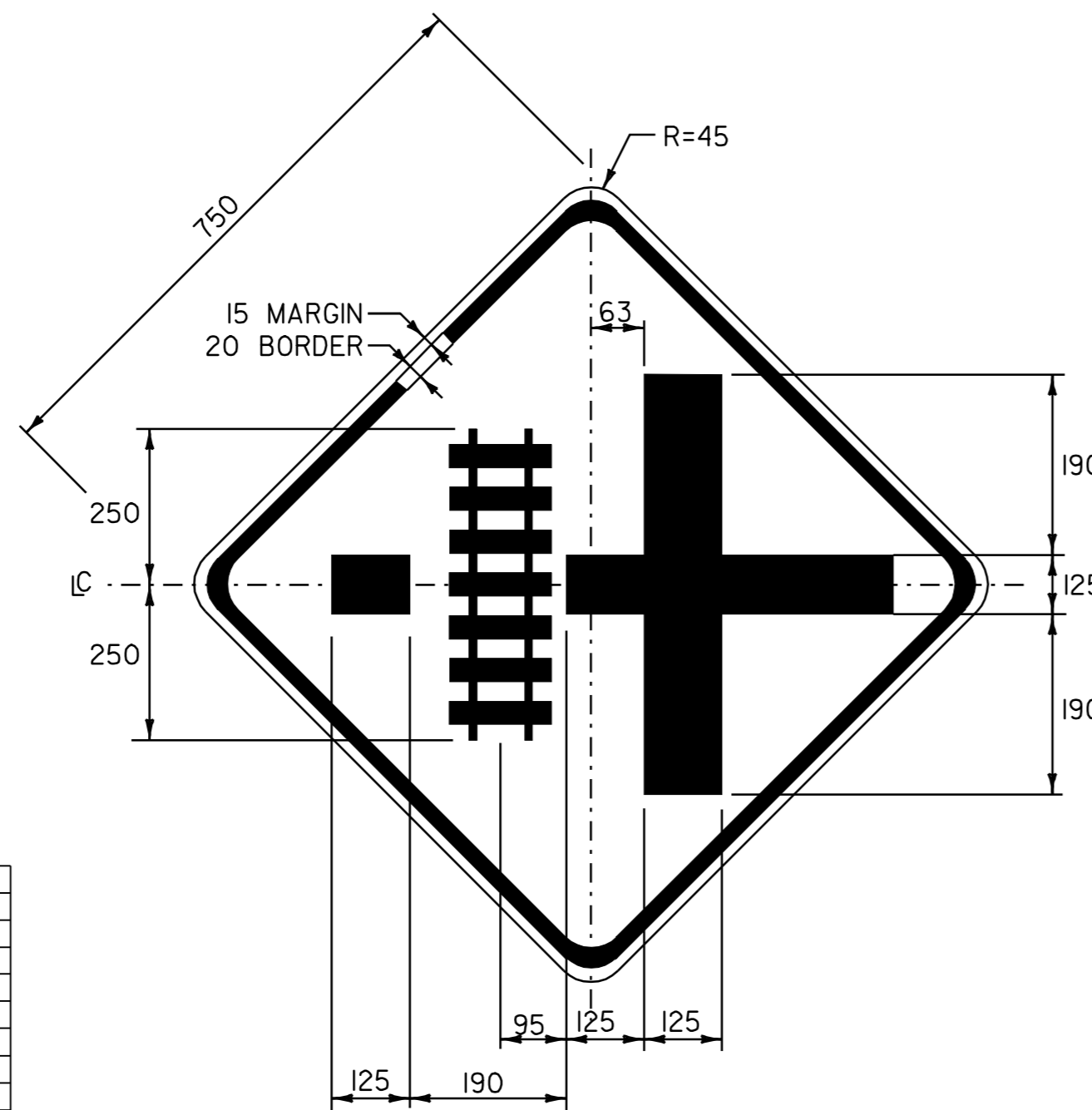

COLOR: BLACK BORDER & TEXT
YELLOW BACKGROUND (REFLECTORIZED)
MATERIAL: PER VAOT STANDARD E-153M
SIGN - VT. ROUTE 103

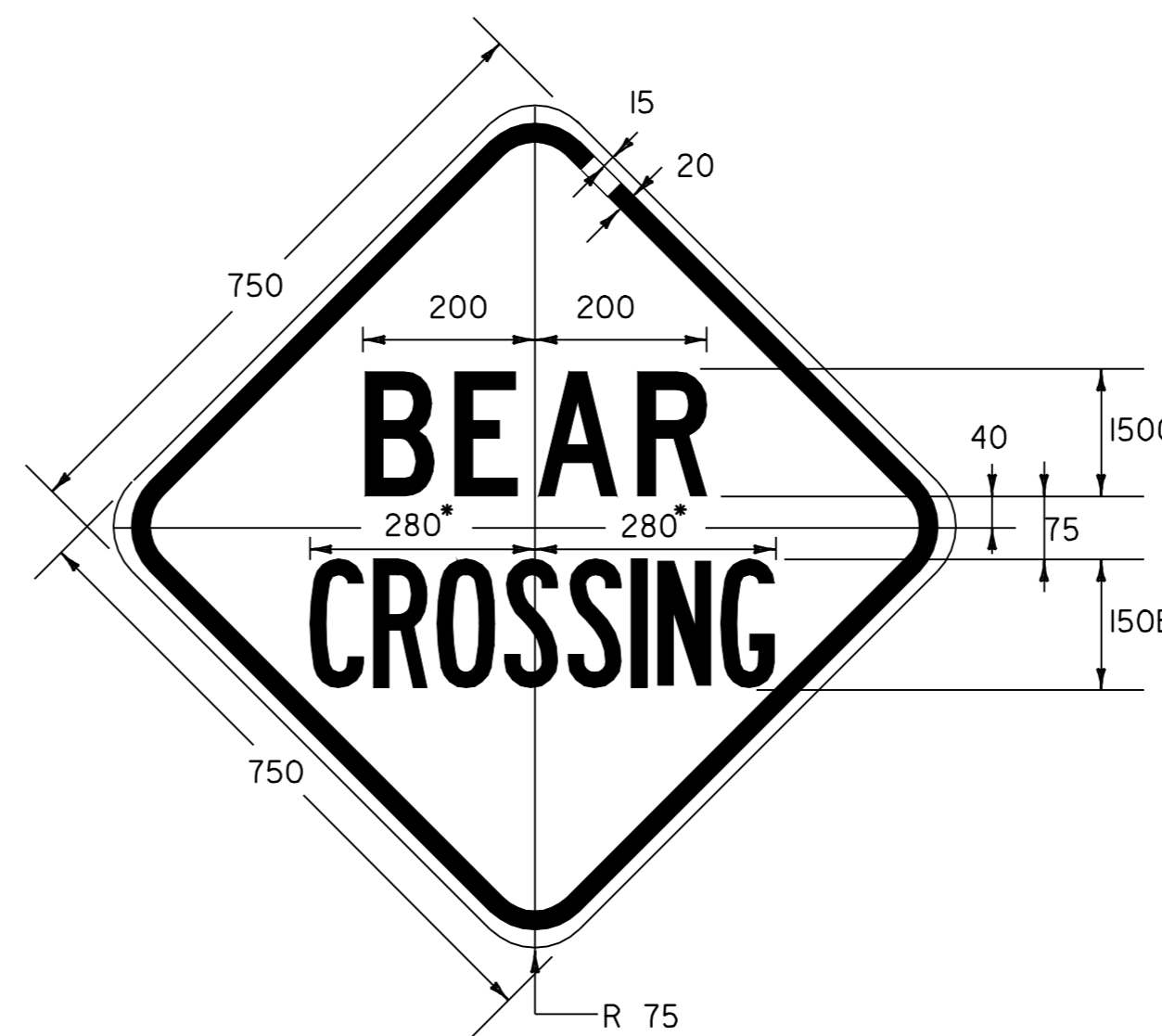
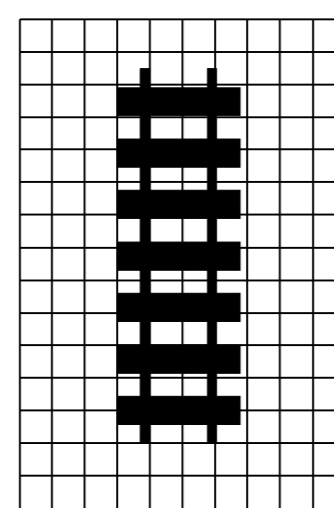

VW-050

* REDUCE SPACING 50%



VD-618

WHITE TEXT + BORDER
BLUE BACKGROUND

NOTE:

TEXT LAYOUT DIMENSIONS ARE BASED ON THE "LETTER & NUMERAL WIDTHS & SPACE" TABLES FOUND IN THE "STANDARD HIGHWAY SIGNS" BOOKLET. MINOR VARIATIONS IN TEXT DIMENSIONS ARE ACCEPTABLE BASED ON INDIVIDUAL MANUFACTURER'S LETTER FABRICATION. SIGNIFICANT CHANGES THAT AFFECT SIGN APPEARANCE SHALL BE BROUGHT TO THE ATTENTION OF THE VAOT'S TRAFFIC AND SAFETY DIVISION BEFORE FABRICATION.

**TRAFFIC SIGN
DETAIL
SHEET**

SURVEYED BY	N/A	DATE	N/A
DRAWN BY	C.A.K.	DATE	
SQUAD LEADER	T.P.K.		
DESIGN FILE NO.	/pave/01b024/pb024.dgn		
IPARM FILE	pb024tsdJ	DATE PLOTTED	\$DATE\$
PROJ. NAME	LUDLOW - MI. HOLLY		
PROJ. NO.	NH_232(I)S		
SHEET	75	OF	84
		SHEETS	

DATUM	
VERTICAL	N/A
HORIZONTAL	N/A