

COLORS
 LEGEND AND BORDER - RED (REFL.)
 BACKGROUND - WHITE (REFL.)
 ENCAPSULATED LENS

R1-2

SIGN	DIMENSIONS (INCHES)									
	A	B	C	D	E	F	G	H	J	
BIKE	24	3/8	3	1 3/8	2C	3 1/4	3	1/8	1/2	
MIN.	30	5/8	4	1 7/8	2 1/2 C	3 3/8	3 5/8	7/8	1/2	
STD.	36	3/4	5	2	3C	4 1/8	4 3/8	1 1/4	2	
EXPWY.	48	1	6	2 3/4	4C	6 1/4	5 3/8	2	3	
SPECIAL	60	1 1/2	8	3 1/2	5C	7 1/8	7 1/4	2 1/2	4	

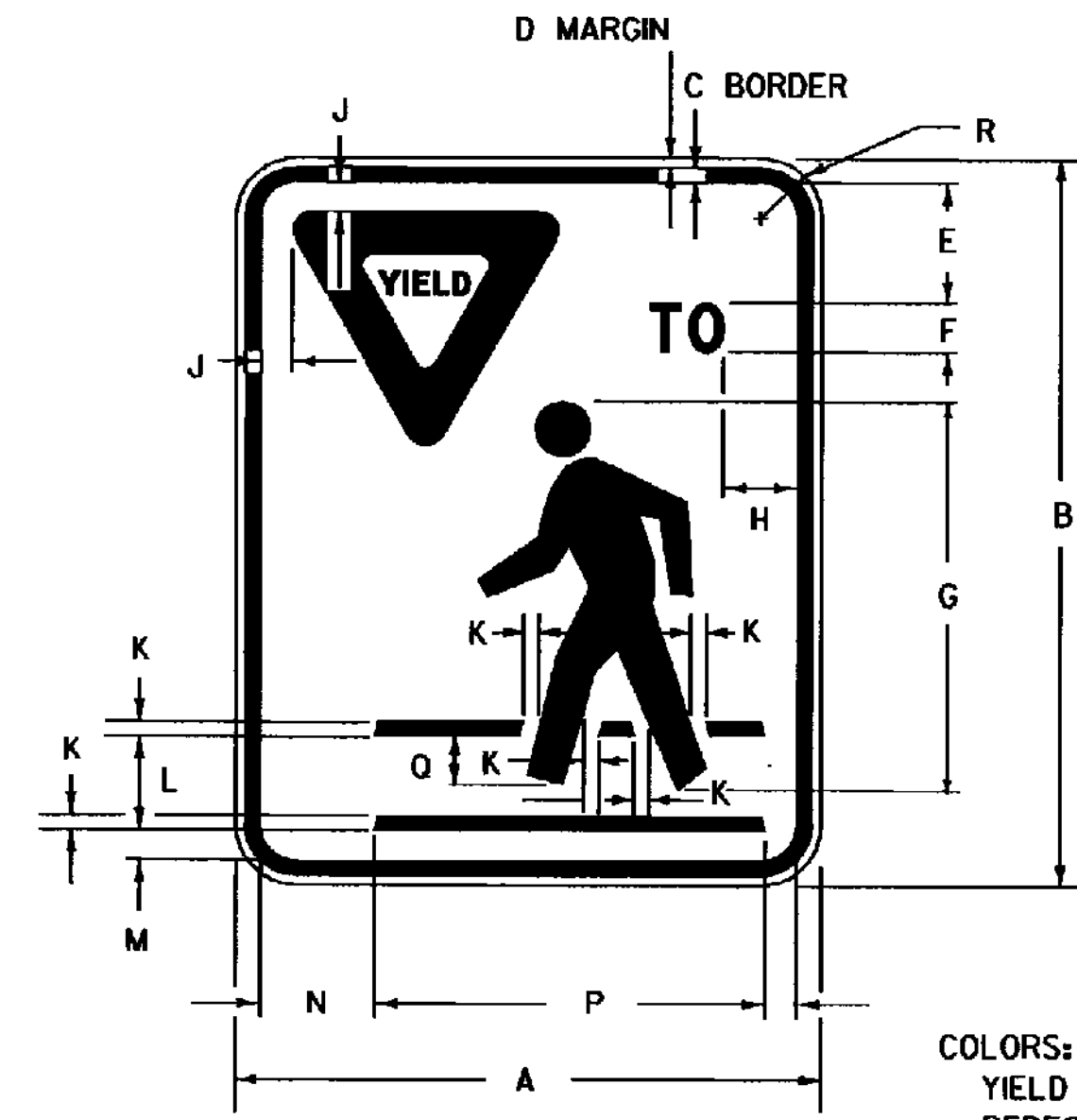

COLORS:
 YIELD TO PEDESTRIAN SIGNS HAVE A BLACK PEDESTRIAN SYMBOL, BLACK TEXT, A BLACK BORDER AND A REFLECTORIZED RED YIELD SYMBOL ON A REFLECTORIZED WHITE BACKGROUND

VR-004A

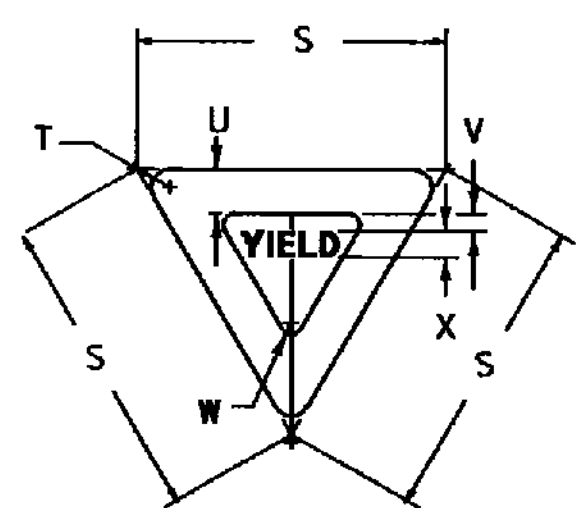

SIGN	DIMENSIONS (INCHES)										
	A	B	C	D	E	F	G	H	J	K	L
STD.	24	30	5/8	3/8	5	2D	12	2 1/4	5/8	3/8	3 1/4
SIGN	M	N	P	Q	R	S	T	U	V	W	X
STD.	1 1/4	4 3/4	16	2	1 1/2	12	3/4	1 3/4	1/8	1/8	1D

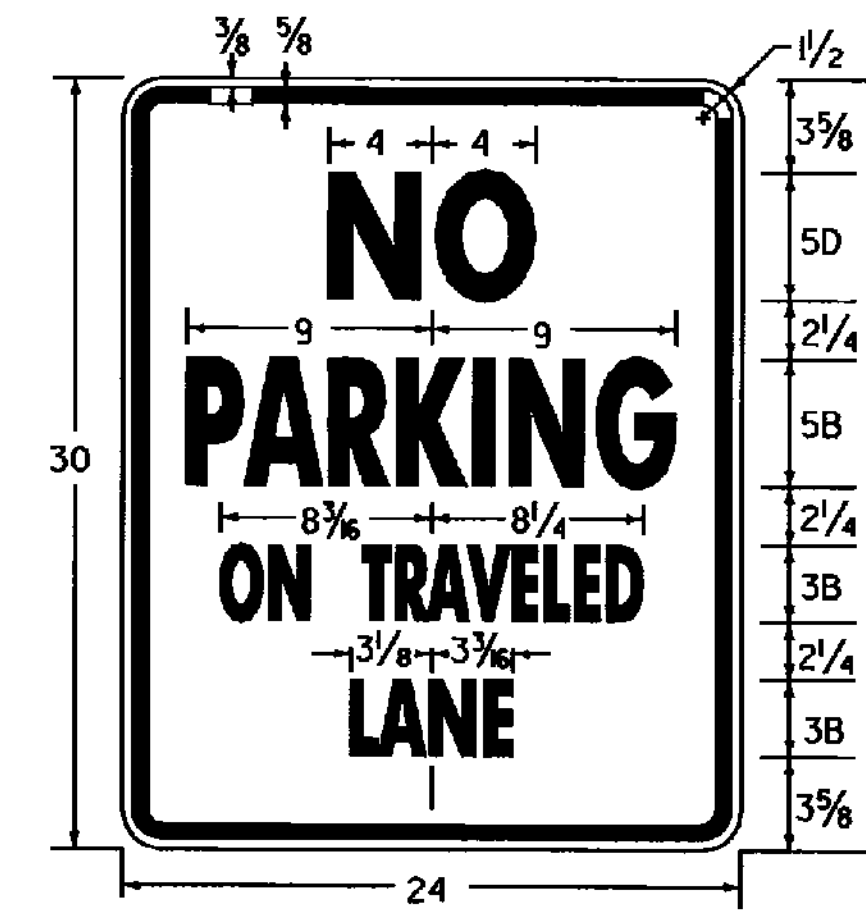
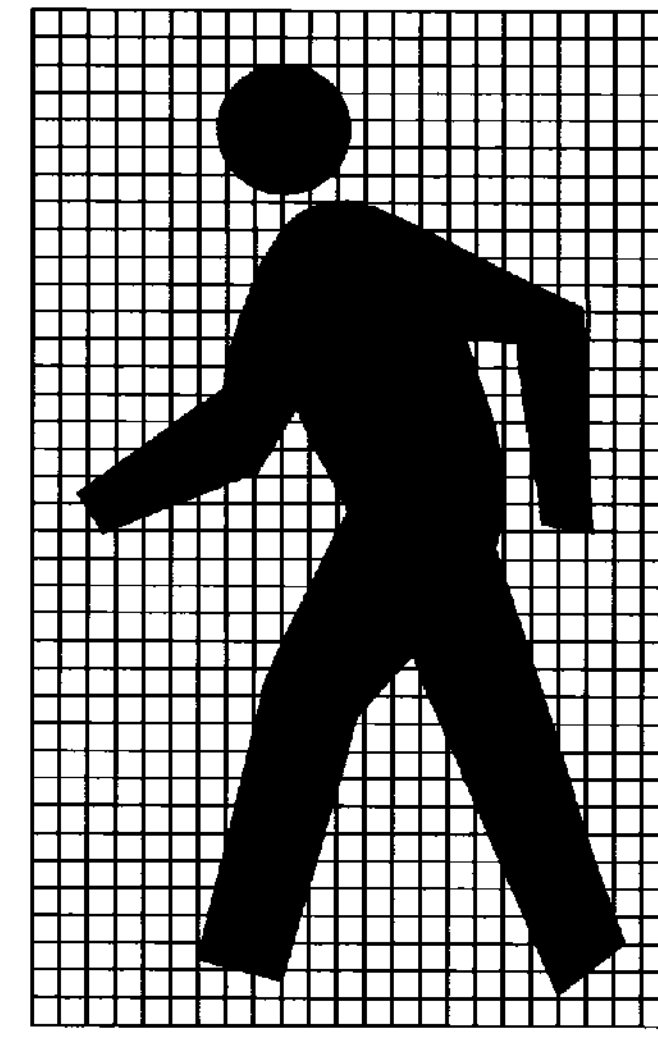

COLORS
 LEGEND - RED (REFL.)
 BACKGROUND - WHITE (REFL.)

VR - 020

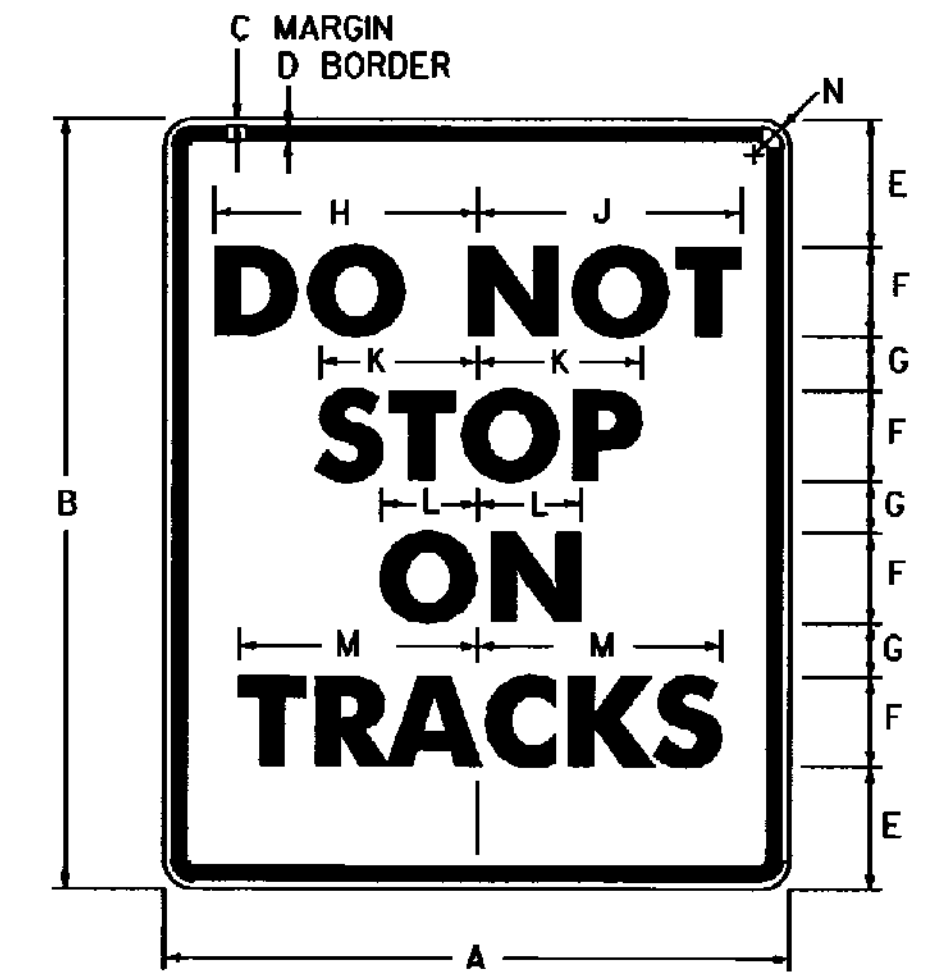

R8-8

SIGN	DIMENSIONS (INCHES)													
	A	B	C	D	E	F	G	H	J	K	L	M	N	
STD.	24	30	3/8	5/8	3 5/8	4D	2 1/4	9 1/4	9 5/8	6 9/16	3 1/2	10	1 1/2	
SPECIAL	36	48	5/8	7/8	6	6D	4	14	14 1/16	9 3/4	5 1/4	15	2 1/4	
SPECIAL	48	60	3/4	1 1/4	7 1/4	8D	4 1/2	18 1/2	19 1/4	13 1/8	7	20	3	

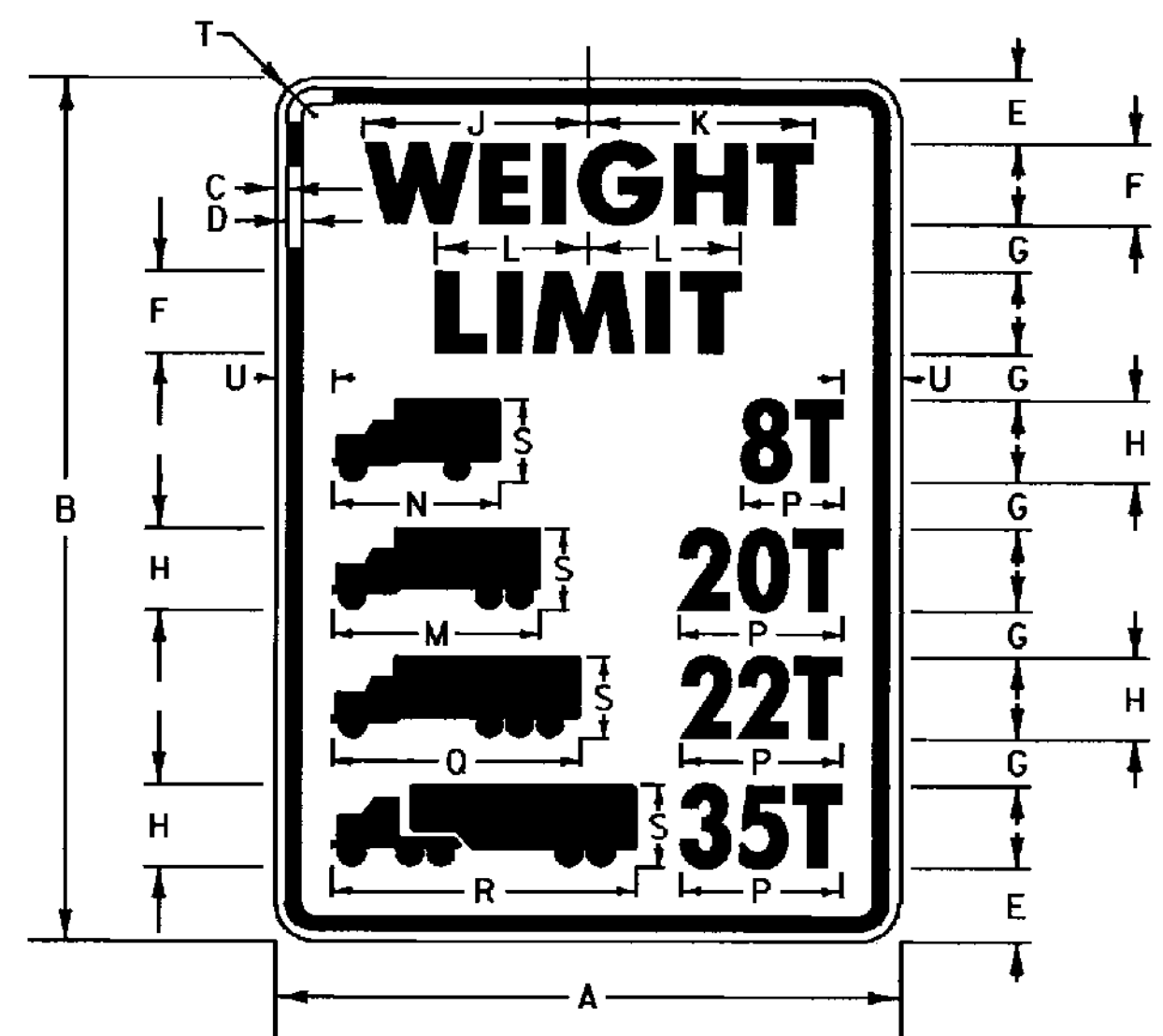

COLORS
 LEGEND - BLACK (NON-REFL.)
 BACKGROUND - WHITE (REFL.)

VR-015

SIGN	DIMENSIONS (INCHES)																		
	A	B	C	D	E	F	G	H	J	K	L	M	N	P	Q	R	S	T	U
MIN.	24	36	3/8	5/8	2 3/4	3E	2 1/2	3C	7 7/8	8 3/8	5 3/4	7 1/4	6	var	9 1/2	11	3	1 1/2	2 1/2
STD.	30	42	1/2	3/4	3 3/8	4E	2 1/4	4C	10 1/2	11 1/8	7 3/8	10	8	var	12	14 5/8	4	1 7/8	2 3/4
EXPWY.	36	54	5/8	7/8	3 7/8	5E	3 1/4	5C	13 3/8	14	9 1/8	12 1/2	10	var	15	18 3/8	5	2 1/4	3
FWY.	48	66	3/4	1 1/4	3 3/4	6E	4 1/2	6C	15 3/4	16 3/4	11 1/2	16	12	var	18	22	6	3	5

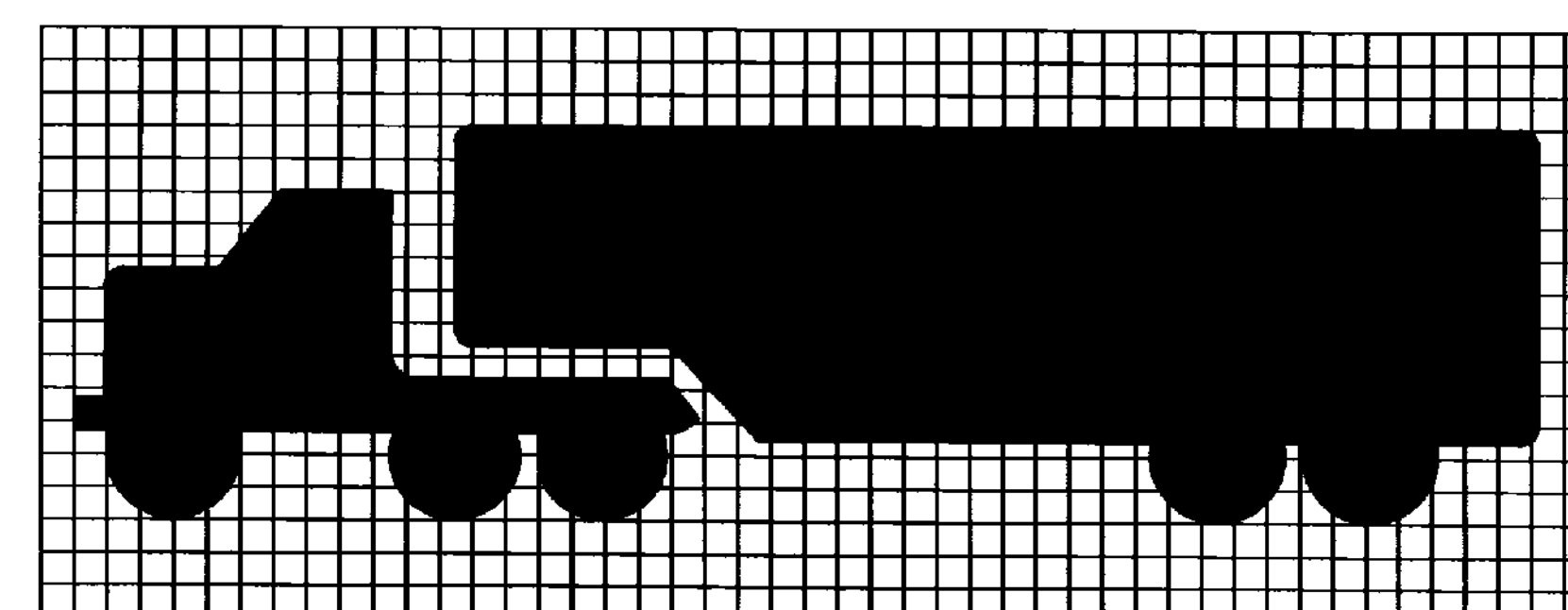
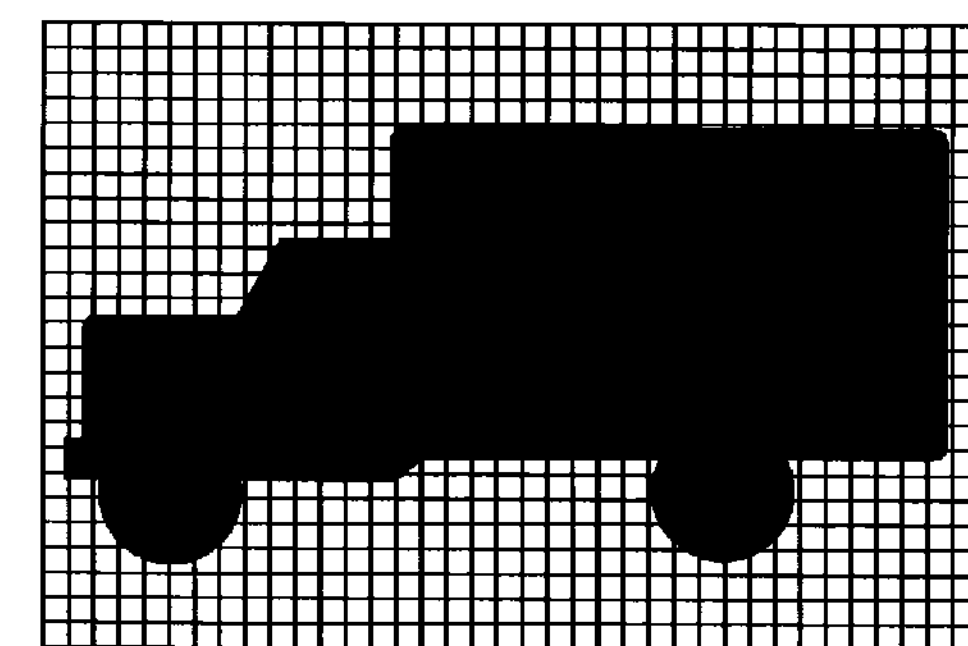
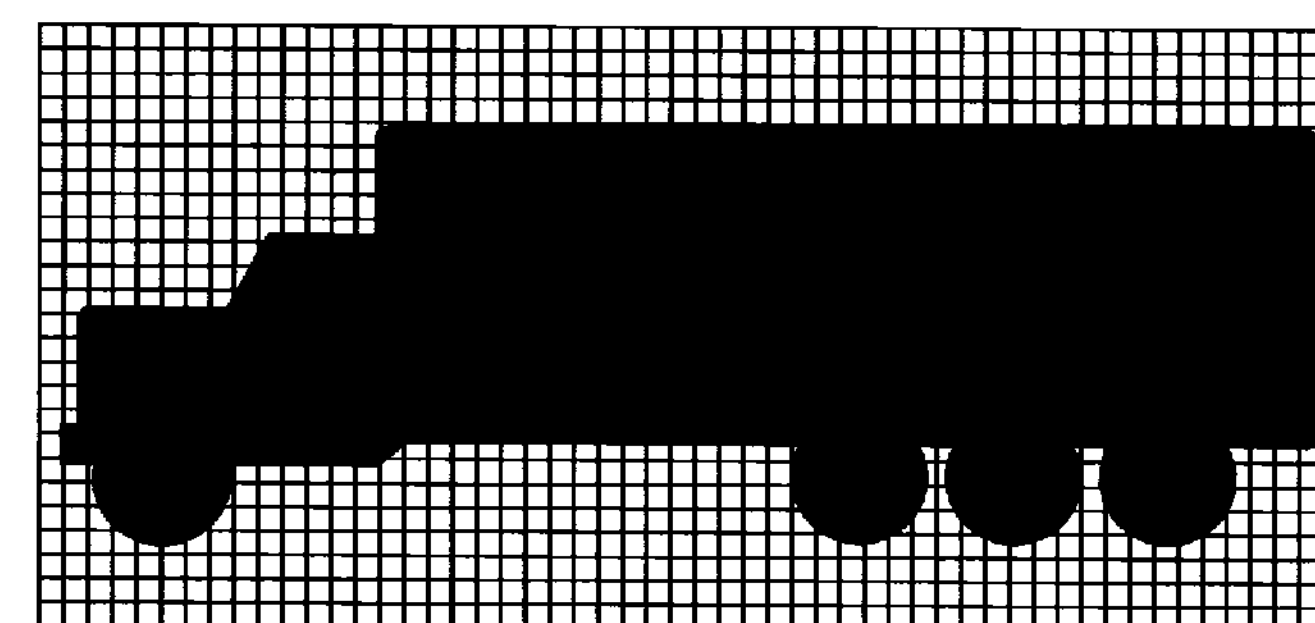
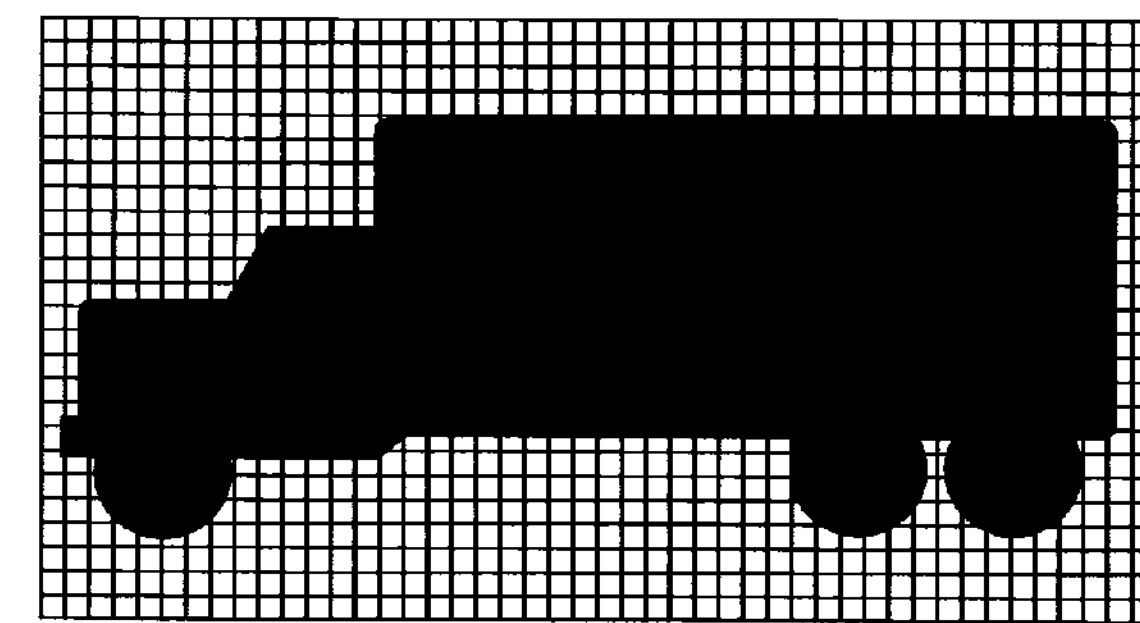

GENERAL:

1. ALL DIMENSIONS IN INCHES.

COLORS:

THE REGULATORY SIGNS SHOWN ON THIS SHEET SHALL BE AS DETAILED FOR EACH SIGN. THE COLORS SHALL CONFORM WITH THE COLORS ADOPTED BY THE AMERICAN ASSOCIATION OF STATE HIGHWAY AND TRANSPORTATION OFFICIALS AND APPROVED BY THE DEPARTMENT OF TRANSPORTATION, FEDERAL HIGHWAY ADMINISTRATION.

MATERIALS:

THE SIGN BASE MATERIALS USED FOR REGULATORY SIGNS SHOWN ON THIS SHEET MAY BE ANY OF THE FOLLOWING OF THE MINIMUM THICKNESS NOTED.

24" x 30"	24" x 36"	24" x 48"	36" x 48"	36" x 54"	36" x 60"	48" x 60"	48" x 66"
0.080"	0.100"	0.125"	1/2"	5/8"	5/8"	5/8"	5/8"
FLAT SHEET ALUMINUM	HIGH DENSITY OVERLAID PLYWOOD	GALVANIZED FLAT SHEET STEEL	16 GAGE	14 GAGE	12 GAGE		

THE REFLECTIVE MATERIAL FOR GROUND MOUNTED SIGNS SHALL BE FLAT TOP WHITE REFLECTIVE SHEETING APPLIED TO THE ENTIRE BACKGROUND OF THE SIGN.

TEXT OF THE SIGNS MAY BE LETTERING FILM, SILK SCREENED OR HAND PAINTED. WHEN HAND PAINTED, POOR WORKMANSHIP SHALL BE CAUSE FOR REJECTION.

SPECIFICATIONS:

REGULATORY SIGNS SHALL MEET THE VERMONT STANDARD SPECIFICATIONS FOR "TRAFFIC SIGNS."

TEXT DESIGN:

LETTERS, DIGITS, ARROWS, SPACING AND TEXT DIMENSIONS SHALL CONFORM WITH THE "STANDARD ALPHABET FOR HIGHWAY SIGNS AND PAVEMENT MARKINGS" AND DESIGNS PRESCRIBED IN THE STANDARD HIGHWAY SIGNS AS SPECIFIED IN THE MANUAL ON UNIFORM TRAFFIC CONTROL DEVICES ADOPTED BY THE U.S. DEPARTMENT OF TRANSPORTATION AND FEDERAL HIGHWAY ADMINISTRATION.

OTHER STDS.: NONE REQUIRED

REVISIONS AND CORRECTIONS

SEPT. 20, 1995 - DATE OF ORIGINAL ISSUE

APPROVED FOR THIS PROJECT AND/OR DESIGN IMPLEMENTATION. FHWA FINAL APPROVAL PENDING.

APPROVED

Ernest D. MacArthur
 DIRECTOR OF ENGINEERING

David A. Barr
 TRAFFIC AND SAFETY ENGINEER

**REGULATORY SIGN
 DETAILS**

/traf/std/stdel46.dgn :stdel46.1



**STANDARD
 E-146**