

**PAINTED ISLAND DETAIL**

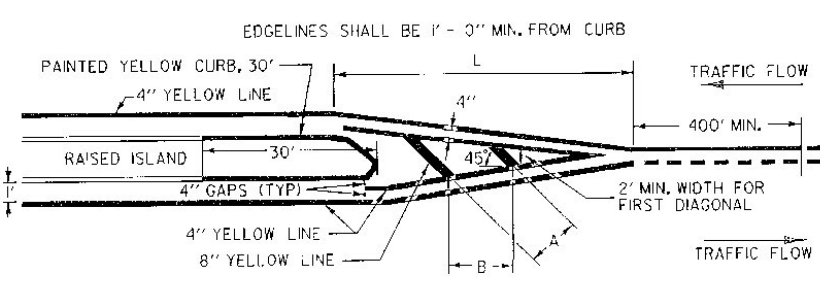

**ISLAND APPROACH MARKINGS**

| DIMENSIONS |     | CONDITIONS FOR USE                                   |   |
|------------|-----|--|---|
| A          | B   |  |   |
| 5'         | 7'  | LOW SPEED OR HIGH SPEED/W POOR SIGHT DISTANCE, <200' | WHERE LENGTH OF DIAGONAL AREA IS 75' MAX. |
| 10'        | 14' | HIGH SPEED AND GOOD SIGHT DISTANCE, >200'            | WHERE LENGTH OF DIAGONAL AREA EXCEEDS 75' |

**TAPER LENGTH NOTES**

- FOR SPEEDS 45 MPH OR MORE,  $L = S \times W$
- FOR SPEEDS 40 MPH OR LESS,  $L = W \times S^2 / 60$   
 $S = 85\text{TH PERCENTILE SPEED OR POSTED SPEED LIMIT IN MILES PER HOUR.}$   
 $W = \text{OFFSET DISTANCE IN FEET}$
- MINIMUM LENGTH OF TAPER = (L)  
 $L = 100 \text{ FEET IN URBAN AREA}$   
 $L = 200 \text{ FEET IN RURAL AREAS}$
- LENGTH "L" CAN BE EXTENDED AS REQUIRED TO IMPROVE VISIBILITY OR TO PROVIDE A SMOOTHER TRANSITION

**NOTE:**

A SOLID LINE IN THE DIRECTION OF TRAVEL IS BEGUN AT A LOCATION 400 FEET MIN. IN ADVANCE OF THE BEGIN TAPER FOR THE PAVEMENT WIDTH TRANSITION.

PASSING ZONE SHOWN FOR REFERENCE ONLY, ACTUAL MARKINGS BASED ON FIELD CONDITIONS.

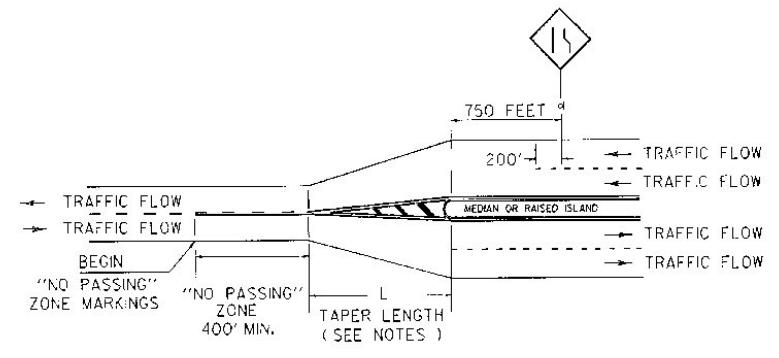

**"NO PASSING" ZONE LAYOUT IN PAVEMENT WIDTH TRANSITIONS, TWO LANE HIGHWAY TO DIVIDED HIGHWAY**

THE FOLLOWING GUIDELINES WILL BE USED WHEN PAINTING ISLAND ON STATE HIGHWAYS AND RECOMMENDED FOR ISLANDS ON OTHER SYSTEMS WITHIN THE STATE.

- PAINTING:** ISLANDS WHICH ARE FOUR FEET IN WIDTH AND TRIANGLE ISLANDS WHICH ARE LESS THAN FOUR HUNDRED AND FIFTY SQUARE FEET SHALL BE PAINTED ENTIRELY. TRIANGLES WHICH ARE FOUR HUNDRED AND FIFTY SQUARE FEET AND LARGER SHALL BE PAINTED WITH A FOUR FOOT BORDER AS SHOWN ON FIGURE "A" OF THE PAINTED ISLAND DETAIL.
- SIGNS:** ALL APPROACH NOSES TO THE ISLANDS IN THE LINE OF TRAFFIC WILL BE SIGNED WITH A KEEP RIGHT (R-47) SIGN AS WELL AS OBJECT MARKERS PLACED BACK TO BACK TO INDICATE THE BEGINNING (END) OF THE ISLAND.
- EXCEPTIONS:** THERE WILL BE SPECIAL CASES WHICH REQUIRE AN EXCEPTION TO, OR MODIFICATION OF THIS GUIDELINE. THESE QUESTIONS SHOULD BE REFERRED TO THE TRAFFIC AND SAFETY ENGINEER OR HIS DELEGATED REPRESENTATIVE.

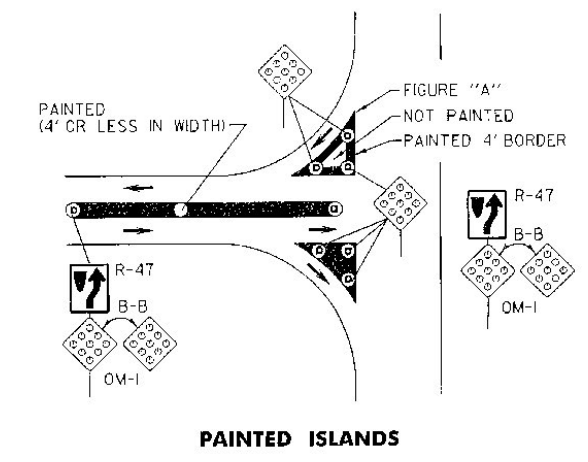

**PAINTED ISLANDS**

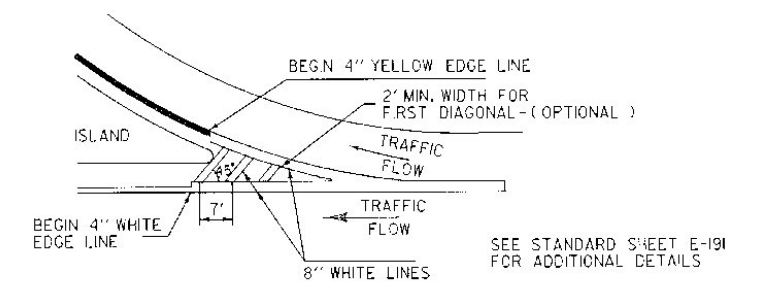

**GORE MARKING DETAIL - EXIT**  
**TRANSVERSE LINES**

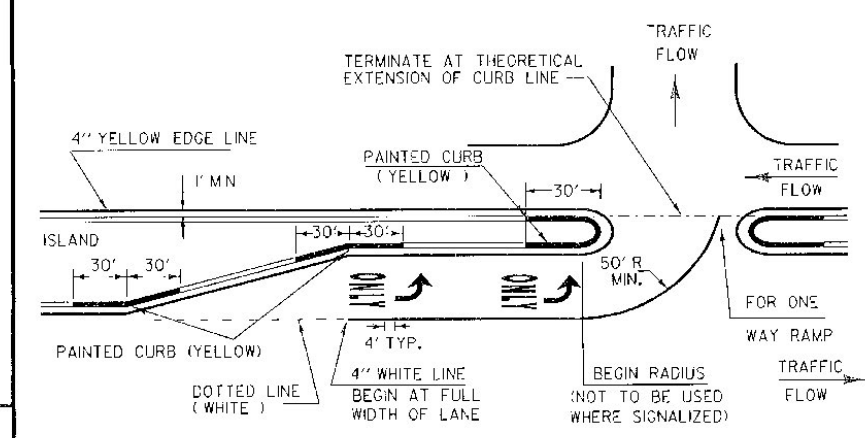

**TURN LANE AND PAINTED CURB DETAIL**

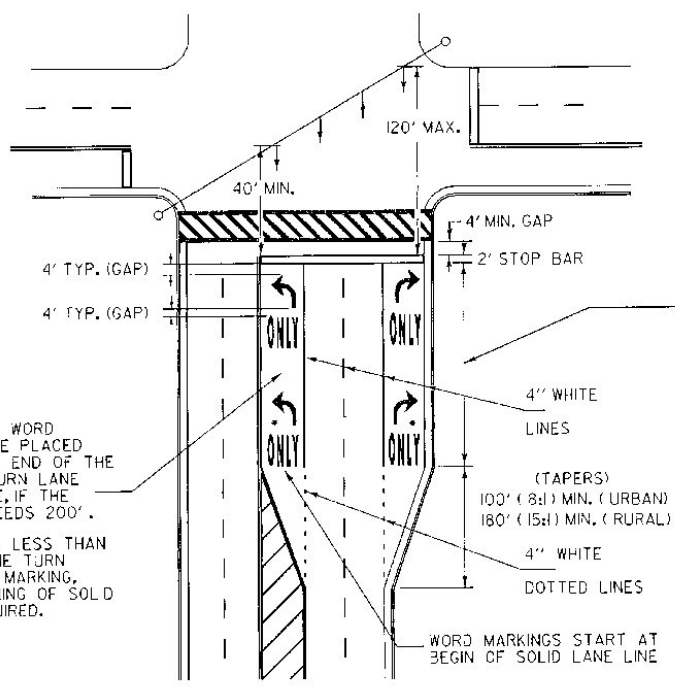

**TYPICAL MARKINGS FOR SIGNALIZED INTERSECTION**

EXCLUSIVE TURN LANES (LEFT OR RIGHT) LANE LINES SHALL BE SOLID AND EXTEND BACK FROM THE STOP LINE TO THE POINT OF FULL LANE WIDTH OF THE TURN LANE.

- THE MINIMUM STORAGE LENGTH IS 50'.
- I. STORAGE LENGTH REQUIRED**
- UNSIGNALIZED  
 $VOL \text{ OF } LT \text{ (HR)} \times \text{CYCLES/HR.} \times 2 \times 25' / \text{VEH.}$   
 (ASSUME A 60 SEC. CYCLE)
  - SIGNALIZED
- ESTIMATED -- USE ABOVE WITH ACTUAL CYCLE LENGTH.
  - PREFERRED METHOD -- HIGHWAY CAPACITY MANUAL, APPENDIX I.
- II. ADDITIONAL STORAGE LENGTH TO BE PROVIDED FOR DECELERATION.**  
 (TAPER/DECEL. FROM CHART) - (MIN. TAPER) - 1/2 (STORAGE - 50')

| AVE. RUNNING SPEED (MPH) | TAPER/DECEL BASED ON A 10 MPH REDUCTION |
|--------------------------|---|
| 20                       | 100'                                    |
| 30                       | 60'                                     |
| 40                       | 235'                                    |
| 50                       | 315'                                    |
| 60                       | 435'                                    |

**THIS SHEET NOT TO SCALE**

**OTHER STDS. E-191 E-193 REQUIRED**

REVISIONS AND CORRECTIONS  
AUG. 18, 1995 - DATE OF ORIGINAL ISSUE

APPROVED

*Scotlyn M. McCullin*  
DIRECTOR OF ENGINEERING

*David A. Ross*  
TRAFFIC AND SAFETY ENGINEER

APPROVED FOR THIS PROJECT AND/OR DESIGN IMPLEMENTATION, FHWA FINAL APPROVAL PENDING.

**PAVEMENT MARKING DETAILS**

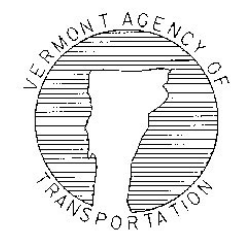

**STANDARD E-192**