

SYMBOL DETAILS

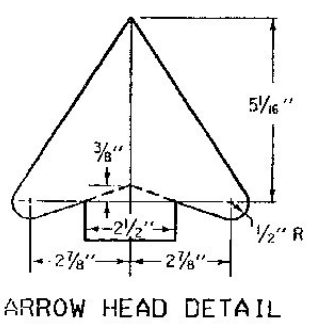

ARROW HEAD DETAIL

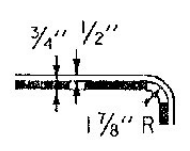

BORDER/MARGIN DETAIL

- NOTES:
1. OPTICALLY CENTER SYMBOLS WITHIN SECTIONS UNLESS OTHERWISE NOTED.
 2. "VR-9XX" IS THE SIGN CODE NUMBER.
 3. MIRROR IMAGES ARE NOT SHOWN BUT CARRY THE SAME CODE NUMBER.
 4. THESE SIGNS ARE INTENDED FOR GROUND MOUNTING ONLY.
 5. OTHER VARIATIONS OF THESE STANDARD DESIGNS ARE DEPICTED IN THE VT SIGN IDENTIFICATION MANUAL. WHEN THEY ARE USED THEY SHOULD BE DESIGNED USING THE DIMENSIONS AND DETAILS SHOWN HERE.

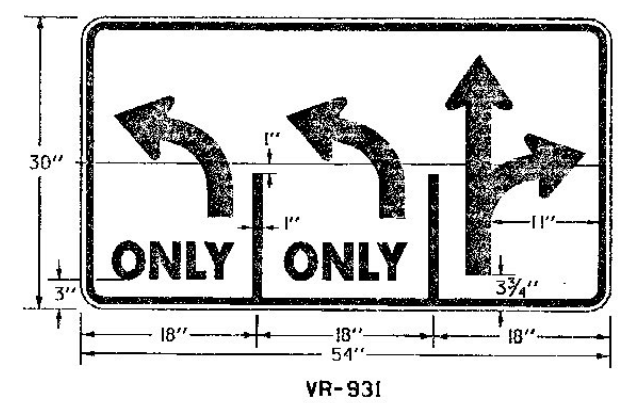

VR-931

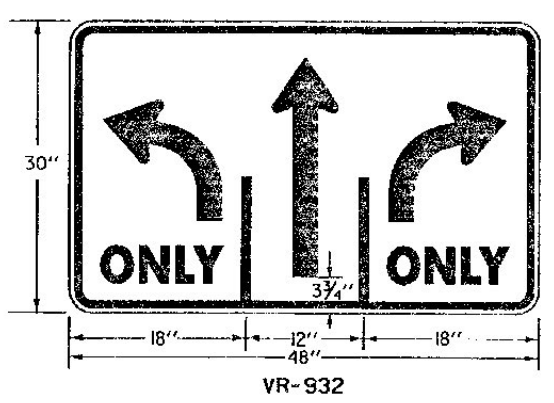

VR-932

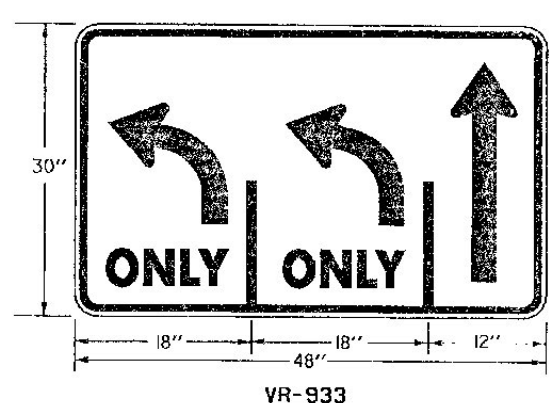

VR-933

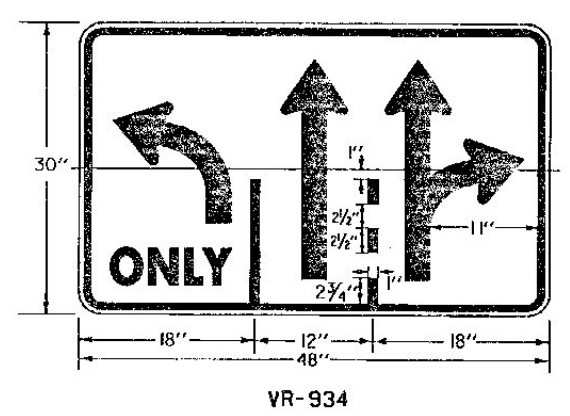

VR-934

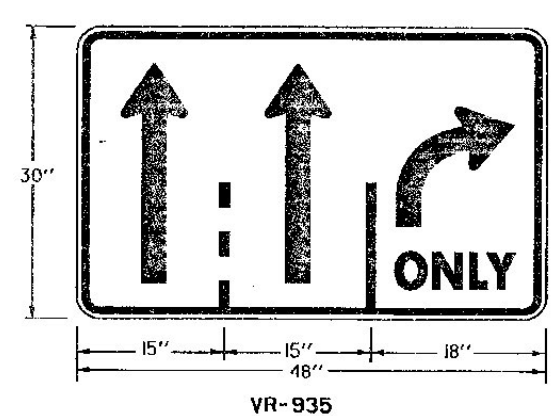

VR-935

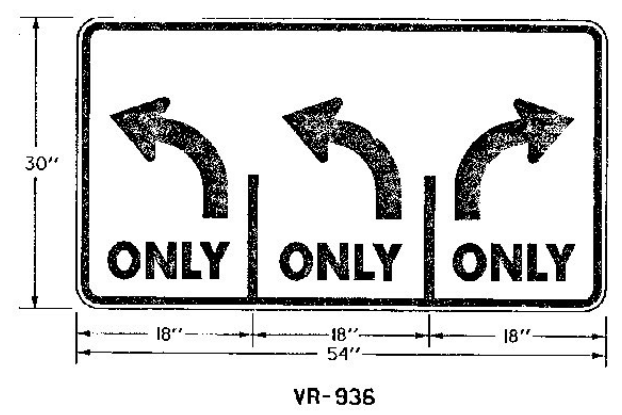

VR-936

COLORS:
 THE REGULATORY SIGNS SHOWN ON THIS SHEET SHALL HAVE BLACK TEXT ON REFLECTORIZED WHITE BACKGROUND. THE COLORS SHALL CONFORM WITH THE COLORS ADOPTED BY THE AMERICAN ASSOCIATION OF STATE HIGHWAY AND TRANSPORTATION OFFICIALS AND APPROVED BY THE DEPARTMENT OF TRANSPORTATION, FEDERAL HIGHWAY ADMINISTRATION.

MATERIALS:
 THE SIGN BASE MATERIALS USED FOR REGULATORY SIGNS SHOWN ON THIS SHEET MAY BE ANY OF THE FOLLOWING OF THE MINIMUM THICKNESS NOTED.

FLAT SHEET ALUMINUM	48" X 30"
HIGH DENSITY OVERLAID PLYWOOD	54" X 30"
GALVANIZED FLAT SHEET STEEL	0.125"
	5/8"
	12 GAGE

THE REFLECTIVE MATERIAL SHALL BE AASHTO TYPE II OR III WHITE REFLECTIVE SHEETING APPLIED TO THE ENTIRE BACKGROUND OF THE SIGN. THE TEXT OF THE SIGNS MAY BE LETTERING FILM, SILK SCREENED OR HAND PAINTED. HAND PAINTING MUST BE COMPARABLE IN QUALITY TO THE RESULTS OBTAINED BY SILK SCREENING.

SPECIFICATIONS:
 REGULATORY SIGNS SHALL MEET THE VERMONT STANDARD SPECIFICATIONS FOR TRAFFIC SIGNS.

TEXT DESIGN:
 LETTERS, DIGITS, ARROWS, SPACING AND TEXT DIMENSIONS SHALL CONFORM WITH THE "STANDARD ALPHABET FOR HIGHWAY SIGNS AND PAVEMENT MARKINGS" AND DESIGNS PRESCRIBED IN THE STANDARD HIGHWAY SIGNS AS SPECIFIED IN THE MANUAL ON UNIFORM TRAFFIC CONTROL DEVICES.

REVISIONS AND CORRECTIONS
 DEC. 23, 1994 - DATE OF ORIGINAL ISSUE

APPROVED
Gordon D. McArthur
 DIRECTOR OF ENGINEERING

David A. Ross
 TRAFFIC AND SAFETY ENGINEER

REGULATORY SIGN DETAILS
 LANE USE CONTROL SIGNS
 THREE LANE APPROACHES

OTHER STDS. REQUIRED	NONE
	STANDARD E-145 B