

ARROW HEAD	DIMENSIONS (INCHES)				
	SIZE	B	C	D	E
MINIMUM	18x24	3 1/2	6 1/8	1 1/8	3 1/8
STANDARD	24x30	4 3/8	8 3/8	3 3/8	1 3/8
EXPRESSWAY	36x48	6 1/8	12 3/8	1 3/8	1 3/8
FREEWAY	48x60	9 3/8	16 1/4	1 1/4	1 3/8

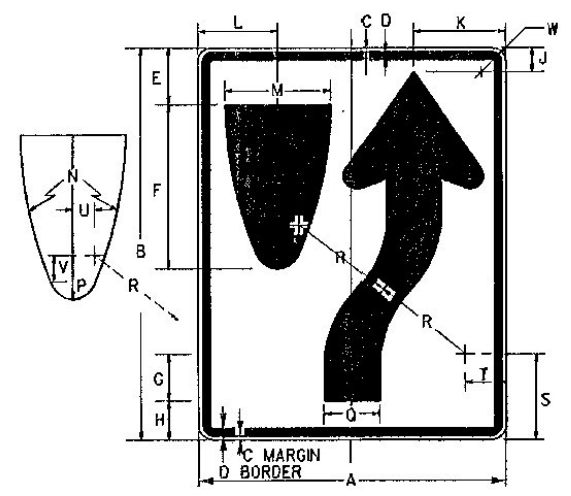

SIGN	DIMENSIONS (INCHES)										
	A	B	C	D	E	F	G	H	J	K	L
MIN	18	24	3/8	3/8	3 3/8	9 3/8	1 1/8	2 1/4	1 3/8	5 1/2	
STD	24	30	3/8	3/8	4 1/2	12 1/2	2 1/2	3	1 1/8	7 3/8	
EXPWY	36	48	3/8	3/8	6 3/4	18 3/4	3 3/4	4 1/2	2 1/16	11 1/8	
FWY	48	60	3/4	1/4	9	25	5	6	3 3/4	14 1/16	
MIN	4 1/16	6	2 1/2	1 1/2	3	6 3/4	4 1/8	2 1/4	1 1/16	7 1/8	1 1/2
STD	6 1/4	8	30	2	4	9	5 1/2	3	1 3/8	2 1/16	1 1/2
EXPWY	9 3/8	12	45	3	6	13 1/4	8 1/4	4 1/2	2	2 3/4	2 1/4
FWY	12 1/2	16	60	4	8	18	11	6	2 1/16	5	3

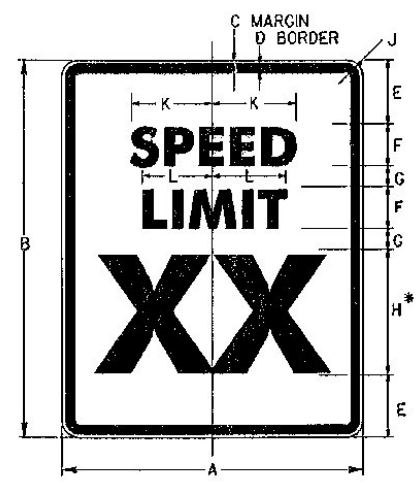

SIGN	DIMENSIONS (INCHES)										
	A	B	C	D	E	F	G	H	J	K	L
MIN	18	24	3/8	3/8	3	3E	2	8E	1 1/2	7 3/8	5 1/2
STD	24	30	3/8	3/8	4	4E	2	10E	1 1/2	9 3/8	7 3/8
EXPWY	36	48	3/8	3/8	6	6E	5	14E	2 1/4	14 3/8	11
FWY	48	60	3/4	1/4	8	8E	4	20E	3	19 3/8	14 3/8

* OPTICALLY SPACE NUMERALS ABOUT VERTICAL CENTERLINE.

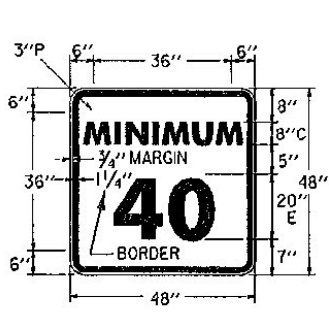

TO BE USED WITH "SPEED LIMIT 65 OR 55" SIGN-FWY ONLY.

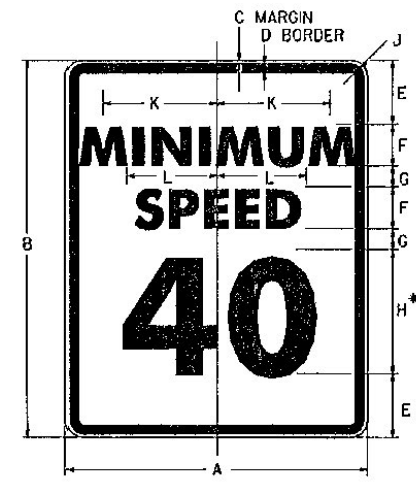

SIGN	DIMENSIONS (INCHES)										
	A	B	C	D	E	F	G	H	J	K	L
MIN & STD	24	30	3/8	3/8	4	4C	2	10D	1 1/2	9 3/8	6 3/8
EXPWY	36	48	3/8	3/8	6	6C	5	14D	2 1/4	13 3/4	10 3/8
FWY	48	60	3/4	1/4	8	8C	6	16D	3	18 3/8	13 3/8

* OPTICALLY SPACE NUMERALS ABOUT VERTICAL CENTERLINE.

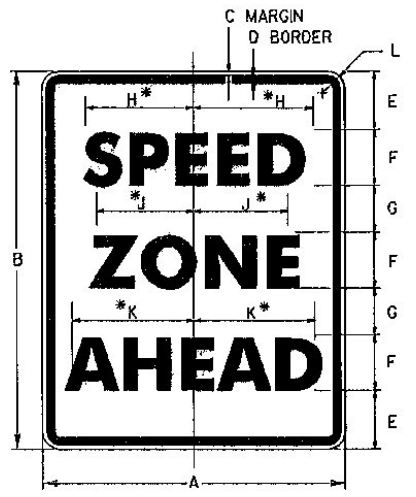
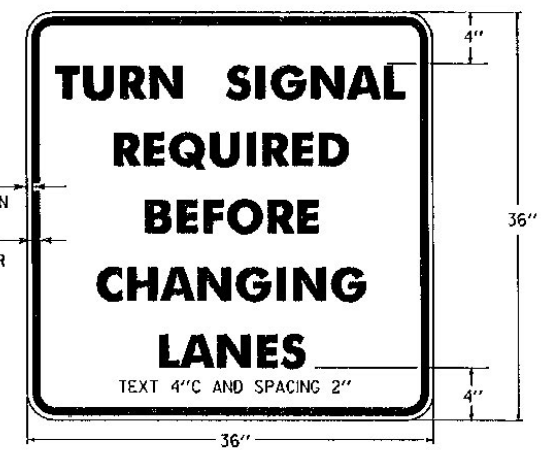

SIGN	DIMENSIONS (INCHES)										
	A	B	C	D	E	F	G	H	J	K	L
MIN.	18	24	3/8	3/8	3 1/2	4C	2 1/2	6 3/8	5 1/2	7	1 1/2
STD.	24	30	3/8	3/8	3 1/2	6C	2 1/2	9 3/8	7 3/8	9 3/4	1 1/2
EXPWY.	36	48	3/8	3/8	7	8C	5	13 3/8	11 1/8	14	2 1/4
FWY.	48	60	3/4	1/4	9	10C	6	17	13 3/8	17 1/2	3

* FOR STD SIZE, REDUCE SPACING 40 %

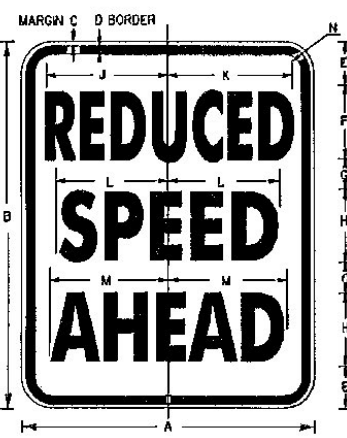

SIGN	DIMENSIONS (INCHES)										
	A	B	C	D	E	F	G	H	J	K	L
MIN.	18	24	3/8	3/8	3 1/2	4B	2 1/2	4C	6 3/8	7	6 3/8
STD.	24	30	3/8	3/8	3 1/2	6B	2 1/2	6C	10	10 3/4	9 3/4
EXPWY.	36	48	3/8	3/8	7	8B	5	8C	14 1/4	14 3/4	13 3/8
FWY.	48	60	3/4	1/4	9	10B	6	10C	17 3/4	18 3/8	17 1/2



SIGN	DIMENSIONS (INCHES)										
	A	B	C	D	E	F	G	H	J	K	L
EXPWY.	30	24	3/8	3/8	3 1/2	4C	2 1/2	4D	12 1/2	13	12 3/4
FWY.	48	36	3/8	3/8	5	6D	4	6D	20 1/8	21 1/8	19 1/8

* FOR FWY SIZE, REDUCE SPACING 50 %

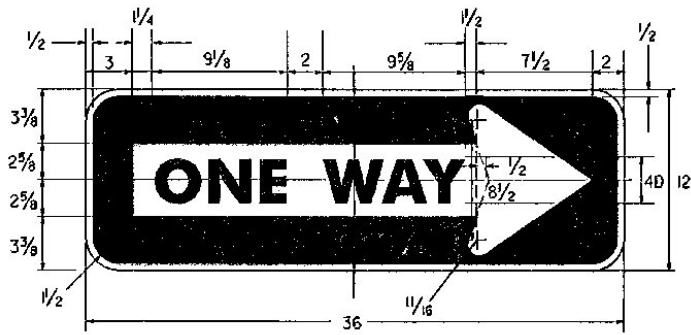

COLORS:

THE REGULATORY SIGNS SHOWN ON THIS SHEET SHALL HAVE BLACK TEXT ON REFLECTORIZED WHITE BACKGROUND. THE COLORS SHALL CONFORM WITH THE COLORS ADOPTED BY THE AMERICAN ASSOCIATION OF STATE HIGHWAY AND TRANSPORTATION OFFICIALS AND APPROVED BY THE DEPARTMENT OF TRANSPORTATION, FEDERAL HIGHWAY ADMINISTRATION.

MATERIALS:

THE SIGN BASE MATERIALS USED FOR THE REGULATORY SIGNS SHOWN ON THIS SHEET MAY BE ANY OF THE FOLLOWING OF THE MINIMUM THICKNESS NOTED.

	36" x 12"	
	36" x 36"	
	36" x 48"	
	48" x 36"	
	48" x 48"	
	48" x 60"	
FLAT SHEET ALUMINUM	0.060"	0.080"
HIGH DENSITY OVERLAID PLYWOOD	1/2"	3/8"
GALVANIZED FLAT SHEET STEEL	18 GAGE	16 GAGE

THE REFLECTIVE MATERIAL FOR GROUND MOUNTED SIGNS SHALL BE FLAT TOP WHITE REFLECTIVE SHEETING APPLIED TO THE ENTIRE BACKGROUND OF THE SIGN. THE TEXT OF THE SIGNS MAY BE LETTERING FILM, SILK SCREENED OR HAND PAINTED. WHEN HAND PAINTED, POOR WORKMANSHIP SHALL BE CAUSE FOR REJECTION.

SPECIFICATIONS:

REGULATORY SIGNS SHALL MEET THE VERMONT STANDARD SPECIFICATIONS FOR "TRAFFIC SIGNS".

TEXT DESIGN:

LETTERS, DIGITS, ARROWS, SPACINGS, AND TEXT DIMENSIONS SHALL CONFORM WITH THE STANDARD ALPHABETS AND DESIGNS PRESCRIBED IN THE MANUAL ON UNIFORM TRAFFIC CONTROL DEVICES.

REVISIONS AND CORRECTIONS

APPROVED

OCT. 30, 1987
DATE
David B. Kelley
CHIEF ENGINEER
Arthur J. Bose
DIRECTOR OF PLANNING
AND PRE-CONSTRUCTION
Stanley A. MacArthur
TRAFFIC AND SAFETY ENGINEER

REGULATORY SIGN
DETAILS

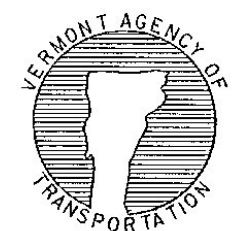

STANDARD
E-142