

INTERSTATE ROUTE MARKER
FOR INDEPENDENT USE

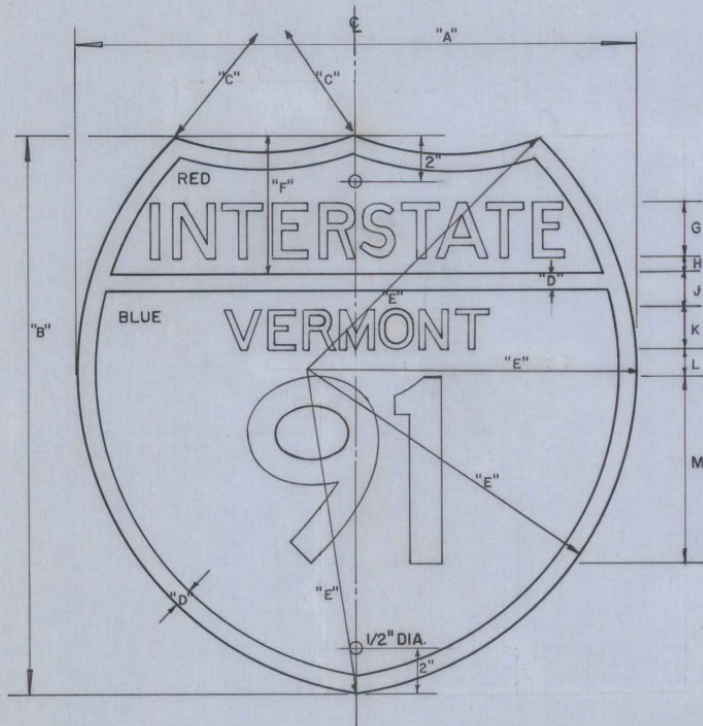

SHIELD SIZE	A	B	C	D	E	F	G	H	J	K	L	M	SQ. FT.
24" x 24"	24"	24"	15"	1/2"	15"	5"	2 1/2"	1/2"	1"	1 1/2"	1/2"	10"	4.0
30" x 24"	30"	24"	24"	1/2"	17"	5"	2 1/2"	1/2"	1"	1 1/2"	1/2"	10"	5.0
36" x 36"	36"	36"	22 1/2"	3/4"	22 1/2"	7 1/2"	3 3/4"	3/4"	1 1/2"	2 1/4"	3/4"	15"	9.0
45" x 36"	45"	36"	36"	3/4"	25 1/2"	7 1/2"	3 3/4"	3/4"	1 1/2"	2 1/4"	3/4"	15"	11.25

INTERSTATE ROUTE MARKER
FOR USE ON GUIDE SIGNS

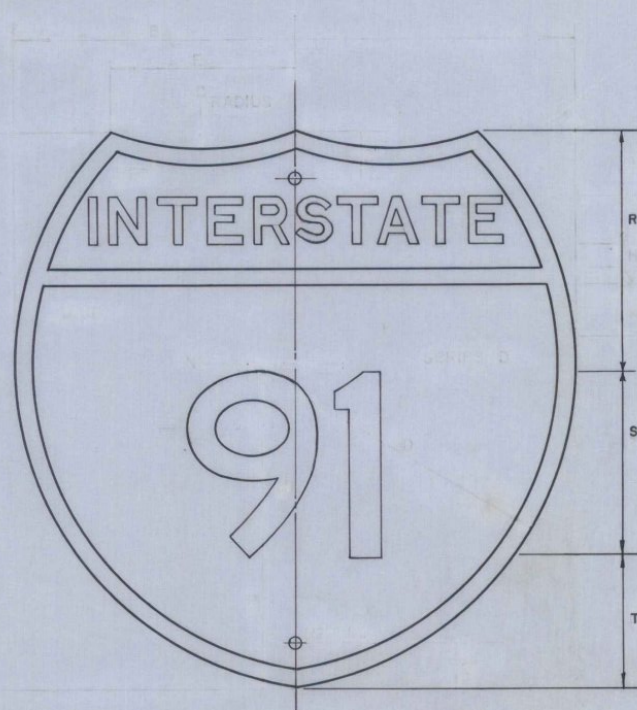

SHIELD SIZE	R	S	T	SQ. FT.
24" x 24"	6 1/2"	12"	5 1/2"	4.0
30" x 24"	6 1/2"	12"	5 1/2"	5.0
36" x 36"	9 3/4"	18"	8 1/4"	9.0
45" x 36"	9 3/4"	18"	8 1/4"	11.25
48" x 48"	13"	24"	11"	16.0

MATERIALS

The Sign Base Material May Be Any Of The Following, Of The Minimum Thickness Noted:

FLAT SHEET ALUMINUM		
Less Than 24" x 24"		0.060"
24" x 24"		0.080"
36" x 36"		0.100"
When used on guide signs		0.060"
HIGH DENSITY OVERLAID PLYWOOD		
Less Than 24" x 24"		3/8"
24" x 24"		1/2"
36" x 36"		5/8"
		3/8"
GALVANIZED FLAT SHEET STEEL		
Less Than 24" x 24"		18 Gage
24" x 24"		16 Gage
36" x 36"		14 Gage

The Reflective Material Shall Be Encapsulated Lens Silver Reflective Sheeting Applied To The Entire Background Of The Marker. The Texts Of The Interstate Route Markers, And Of The Auxiliary Markers Except Trailblazer Auxiliaries, Shall Be Reverse Screened.

CARDINAL DIRECTION MARKERS
FOR USE WITH 24 INCH
INTERSTATE ROUTE MARKERS

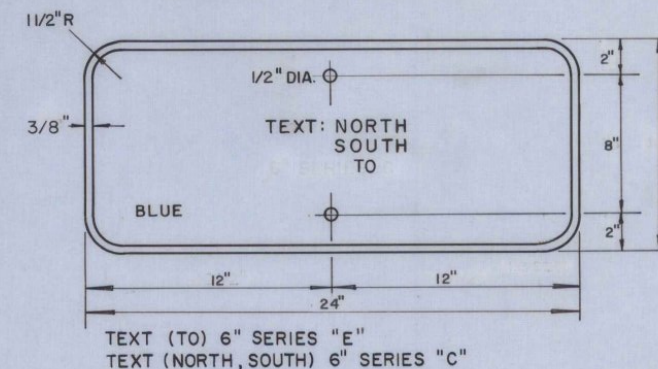

TEXT (TO) 6" SERIES "E"
TEXT (NORTH, SOUTH) 6" SERIES "C"

FOR USE WITH 36 INCH INTERSTATE ROUTE MARKER

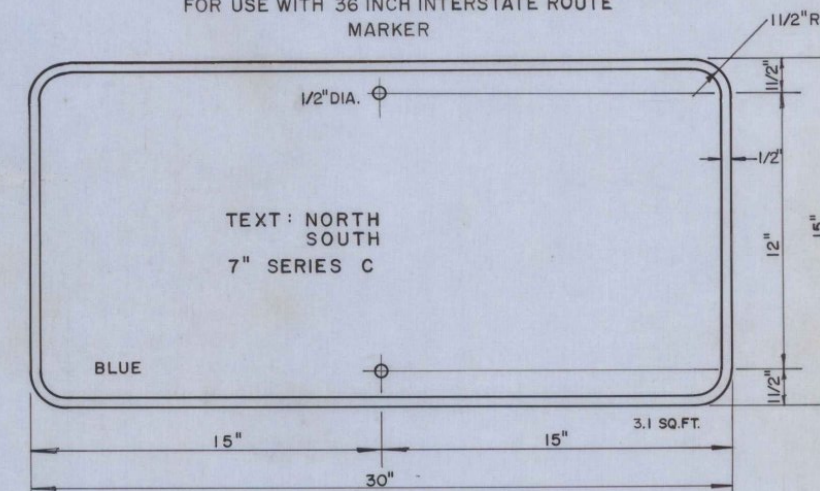

TEXT: NORTH
SOUTH
TO
7" SERIES C

LETTERING

Letters And Digits Shall Conform With The Standard Alphabets For Highway Signs Approved By The National Joint Committee On Uniform Traffic Control Devices.

SPECIFICATIONS

Interstate Route Markers And Auxiliary Route Markers Shall Meet The Standard State Specifications For "Traffic Signs".

DESIGNS

The Designs of Interstate Route Markers and Auxiliary Markers Shall Conform With the Requirements Set Forth in The Manual on Uniform Traffic Control Devices Adopted by the American Association of State Highway Officials.

COLORS

The Official Interstate Route Marker Shall Have A ReflectORIZED White Or Silver Text On A ReflectORIZED Red And Blue Background. Auxiliary Markers Used With Interstate Route Markers Shall Have A ReflectORIZED White Or Silver Text On A ReflectORIZED Blue Background, Except When Used As Part Of A Trailblazer Assembly.

The Red And Blue Shall Conform With The Standard Colors Adopted By The American Association Of State Highway Officials And Approved By The U.S. Department Of Transportation, Federal Highway Administration.

JUNCTION MARKER

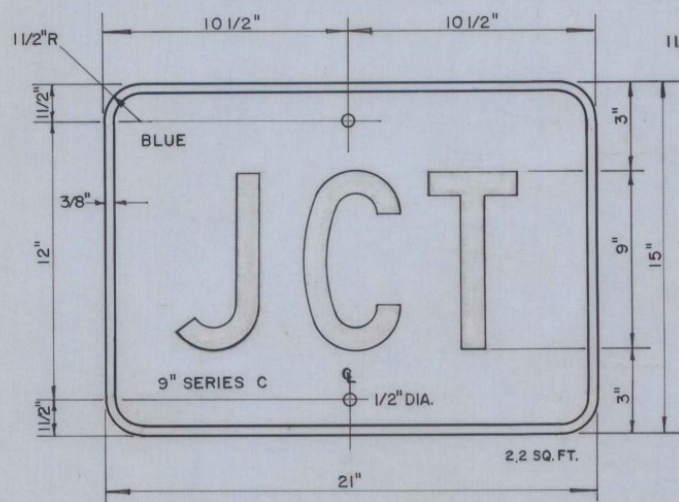

DIRECTIONAL ARROW

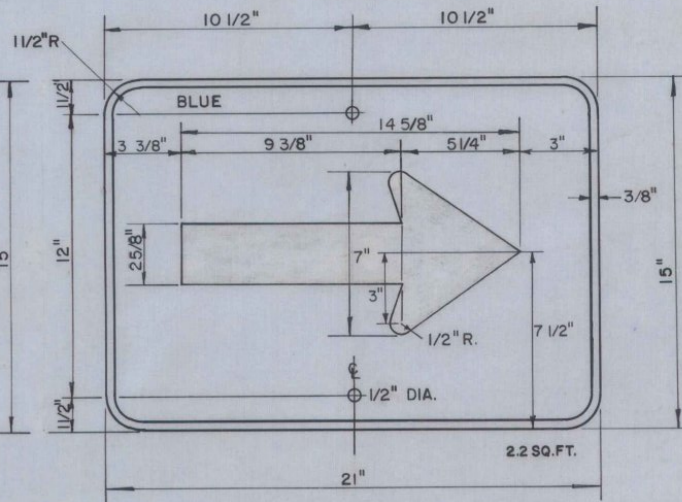

REVISIONS AND CORRECTIONS

APR. 11, 1973 - REVISED ACCORDING TO FEDERAL HIGHWAY ADMINISTRATION INSTRUCTIONS.
MAY 9 - 1974 - ADDITION OF AUXILIARY MARKER (TO)

APPROVED
Dec. 17, 1971

R.H. Arnold
CHIEF ENGINEER
E.W. Stickney
ASST. CHIEF ENGINEER
G.M. Lane
HIGHWAY ENGINEER

DRAWN A.W.C.
TRACED R.L.E.

TRAFFIC SIGNS (GUIDE SIGNS)
INTERSTATE ROUTE MARKERS
AND AUXILIARY MARKERS

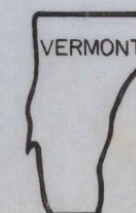

VERMONT
DEPARTMENT
OF HIGHWAYS
STANDARD

E-11