

WI-3R

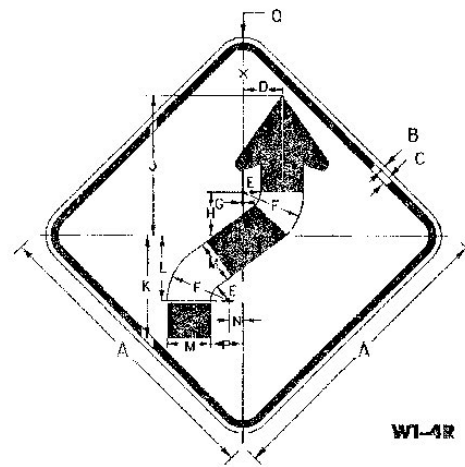

WI-4R

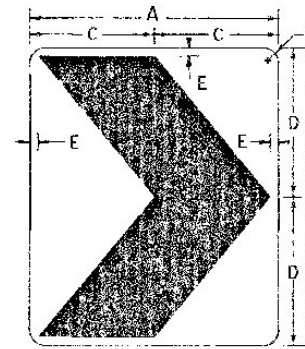

WI-8

| SIGN    | DIMENSIONS (INCHES) |    |    |    |       |       |
|---------|---------------------|----|----|----|-------|-------|
|         | A                   | B  | C  | D  | E     | F     |
| STD.    | 18                  | 24 | 9  | 12 | 3/4   | 1 1/2 |
| SPECIAL | 24                  | 30 | 12 | 15 | 1 1/8 | 1 7/8 |
| EXPWY.  | 30                  | 36 | 15 | 18 | 1 1/4 | 2 1/4 |
| FRWY.   | 36                  | 48 | 18 | 24 | 1 5/8 | 2 5/8 |

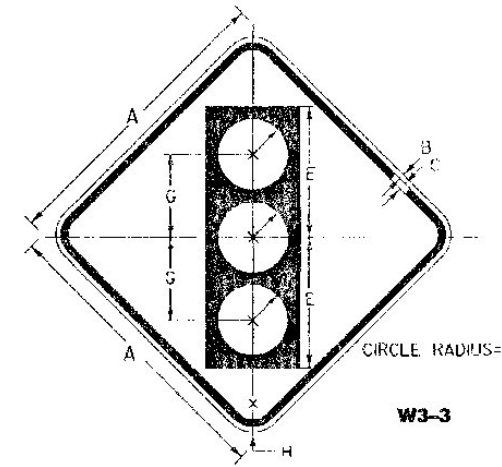

W3-3

| SIGN        | DIMENSIONS (INCHES) |     |       |       |       |       |        |       |
|-------------|---------------------|-----|-------|-------|-------|-------|--------|-------|
|             | A                   | B   | C     | D     | E     | F     | G      | H     |
| STD. & MIN. | 36                  | 3/8 | 7/8   | 5 3/4 | 5 3/4 | 4 1/4 | 10     | 2 1/4 |
| SPECIAL     | 48                  | 3/4 | 1 1/4 | 7 1/2 | 7 1/2 | 5     | 12 1/2 | 3     |

**COLORS**

SYMBOL & LEGEND - BLACK (NON-REFL)  
 BACKGROUND - ORANGE (REFL)  
 TOP CIRCLE - RED (REFL)  
 MIDDLE CIRCLE - YELLOW (REFL)  
 BOTTOM CIRCLE - GREEN (REFL)

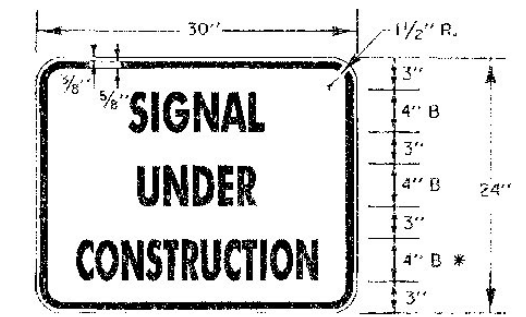

\* REDUCE SPACING 50%

| SIGN        | DIMENSIONS (INCHES) |     |       |        |        |       |       |       |       |        |       |       |
|-------------|---------------------|-----|-------|--------|--------|-------|-------|-------|-------|--------|-------|-------|
|             | A                   | B   | C     | D      | E      | F     | G     | H     | J     | K      | L     | M     |
| STD. & MIN. | 36                  | 5/8 | 7/8   | 17 1/8 | 17 1/8 | 5 1/4 | 1 1/4 | 3 5/8 | 4 1/2 | 12 3/4 | 1 3/4 | 2 1/4 |
| SPECIAL     | 48                  | 3/4 | 1 1/4 | 23 3/8 | 23 3/8 | 7     | 1 5/8 | 4 7/8 | 6     | 16 5/8 | 2 3/8 | 3     |

| SIGN        | DIMENSIONS (INCHES) |     |       |       |       |       |     |       |        |        |        |       |       |       |       |
|-------------|---------------------|-----|-------|-------|-------|-------|-----|-------|--------|--------|--------|-------|-------|-------|-------|
|             | A                   | B   | C     | D     | E     | F     | G   | H     | J      | K      | L      | M     | N     | P     | Q     |
| STD. & MIN. | 36                  | 5/8 | 7/8   | 4 1/2 | 2 1/4 | 7 1/2 | 3/2 | 5 1/4 | 16 7/8 | 12 3/8 | 7 7/8  | 5 1/4 | 1 1/8 | 3 1/8 | 2 1/4 |
| SPECIAL     | 48                  | 3/4 | 1 1/4 | 6 3/8 | 3     | 10    | 3/2 | 7     | 22 1/2 | 16 1/2 | 10 1/2 | 7     | 2 1/4 | 5 1/4 | 3     |

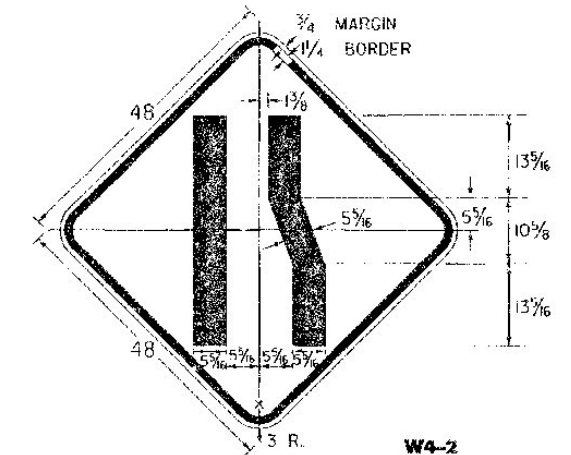

W4-2

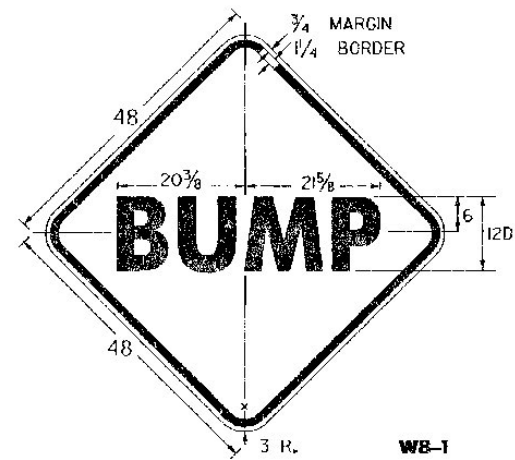

WB-1

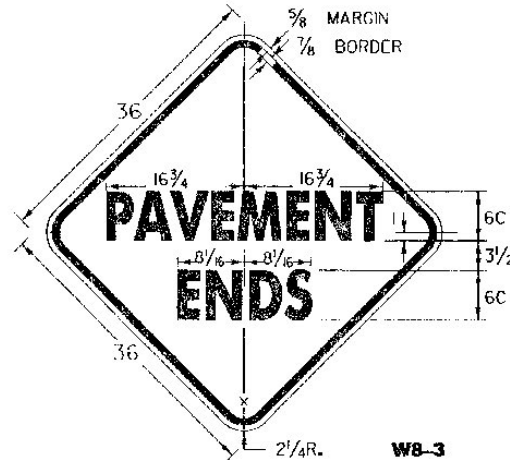

WB-3

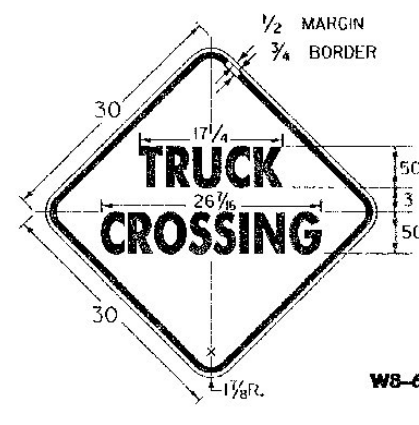

WB-6

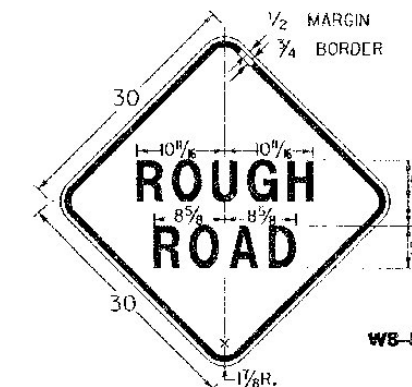

WB-8

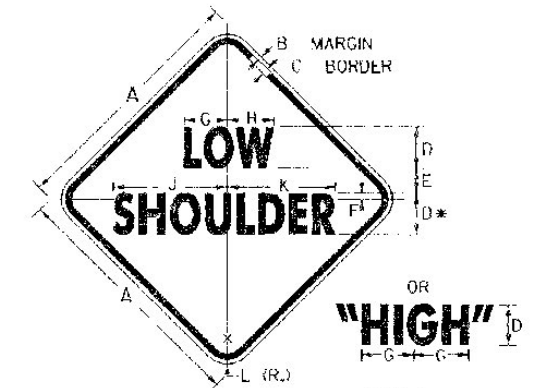

WB-9

| SIGN  | DIMENSIONS (INCHES) |     |       |     |   |       |       |       |        |        |       |
|-------|---------------------|-----|-------|-----|---|-------|-------|-------|--------|--------|-------|
|       | A                   | B   | C     | D   | E | F     | G     | H     | J      | K      | L     |
| STD.  | 30                  | 1/2 | 3/4   | 5 C | 3 | 3/4   | 5 3/4 | 5 3/4 | 13 3/4 | 13 3/4 | 1 3/4 |
| FRWY. | 48                  | 3/4 | 1 1/4 | 6 C | 5 | 1 1/4 | 8 1/4 | 8 1/4 | 21 3/4 | 21 3/4 | 3     |

\* REDUCE SPACING 25%

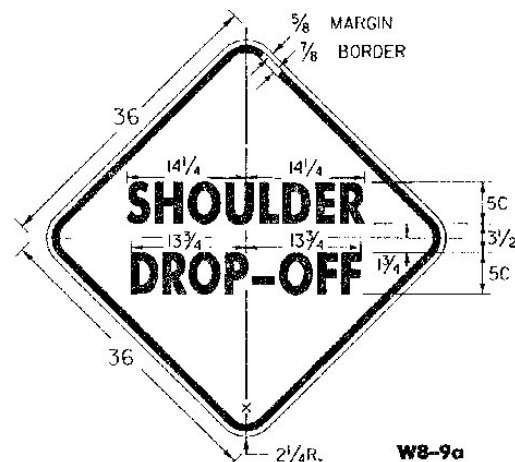

WB-9a

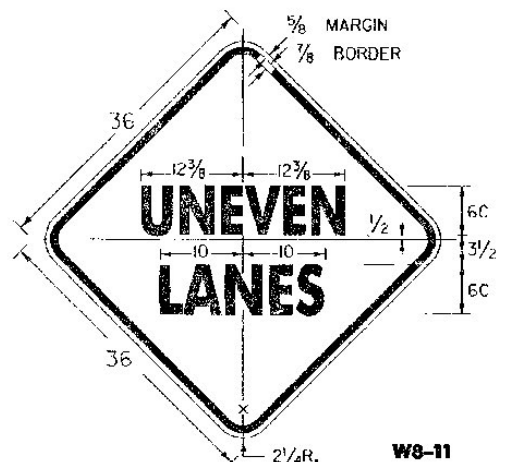

WB-11

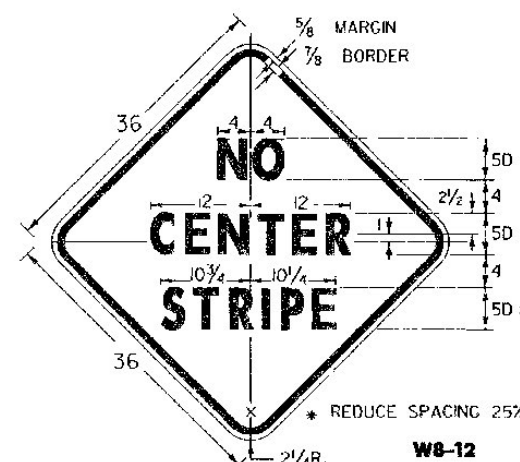

WB-12

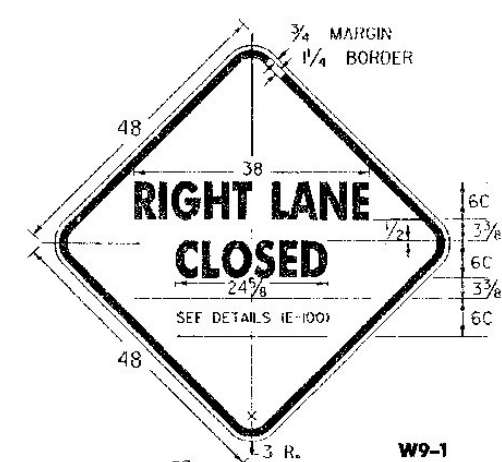

W9-1

(ALL DIMENSIONS SHOWN IN INCHES) LEFT LANE

OTHER STDS. E-100 REQUIRED:

REVISIONS AND CORRECTIONS

OCT. 30, 1987 - DATE OF ORIGINAL ISSUE  
 OCT. 21, 1992 - ADDED ADDITIONAL SIGN DIMENSIONS, REVISED CHEVRON BACKGROUND TO ORANGE, & REVISED TITLE BLOCK  
 AUG. 08, 1995 - ADDED AND DELETED VARIOUS SIGN DETAILS

APPROVED

*Stephen D. MacCallum*  
 DIRECTOR OF ENGINEERING

*David A. Ross*  
 TRAFFIC AND SAFETY ENGINEER

CONSTRUCTION SIGN DETAILS



STANDARD E-101

APPROVED FOR THIS PROJECT AND/OR DESIGN IMPLEMENTATION. FHWA FINAL APPROVAL PENDING.